

User Manual

9240 Series

Multi-Range DC Power Supplies



Safety Summary

The following safety precautions apply to both operating and maintenance personnel and must be followed during all phases of operation, service, and repair of this instrument.

Before applying power to this instrument:

- Read and understand the safety and operational information in this manual.
- Apply all the listed safety precautions.
- Verify that the voltage selector at the line power cord input is set to the correct line voltage. Operating the instrument at an incorrect line voltage will void the warranty.
- Make all connections to the instrument before applying power.
- Do not operate the instrument in ways not specified by this manual or by B&K Precision.

Failure to comply with these precautions or with warnings elsewhere in this manual violates the safety standards of design, manufacture, and intended use of the instrument. B&K Precision assumes no liability for a customer's failure to comply with these requirements.

Category rating

The IEC 61010 standard defines safety category ratings that specify the amount of electrical energy available and the voltage impulses that may occur on electrical conductors associated with these category ratings. The category rating is a Roman numeral of I, II, III, or IV. This rating is also accompanied by a maximum voltage of the circuit to be tested, which defines the voltage impulses expected and required insulation clearances. These categories are:

Category I (CAT I): Measurement instruments whose measurement inputs are not intended to be connected to the mains supply. The voltages in the environment are typically derived from a limited-energy transformer or a battery.

Category II (CAT II): Measurement instruments whose measurement inputs are meant to be connected to the mains supply at a standard wall outlet or similar sources. Example measurement environments are portable tools and household appliances.

Category III (CAT III): Measurement instruments whose measurement inputs are meant to be connected to the mains installation of a building. Examples are measurements inside a building's circuit breaker panel or the wiring of permanently-installed motors.

Category IV (CAT IV): Measurement instruments whose measurement inputs are meant to be connected to the primary power entering a building or other outdoor wiring.

Electrical Power

This instrument is intended to be powered from a CATEGORY II mains power environment. The mains power should be 115 V RMS or 230 V RMS. Use only the power cord supplied with the instrument and ensure it is appropriate for your country of use.

⚠ WARNING

Do not use this instrument in an electrical environment with a higher category rating than what is specified in this manual for this instrument.

⚠ WARNING

You must ensure that each accessory you use with this instrument has a category rating equal to or higher than the instrument's category rating to maintain the instrument's category rating. Failure to do so will lower the category rating of the measuring system.

Ground the Instrument

⚠ WARNING

To minimize shock hazard, the instrument chassis and cabinet must be connected to an electrical safety ground. This instrument is grounded through the ground conductor of the supplied, three-conductor AC line power cable. The power cable must be plugged into an approved three-conductor electrical outlet. The power jack and mating plug of the power cable meet IEC safety standards.

⚠ WARNING

Do not alter or defeat the ground connection. Without the safety ground connection, all accessible conductive parts (including control knobs) may provide an electric shock. Failure to use a properly-grounded approved outlet and the recommended three-conductor AC line power cable may result in injury or death.

⚠ WARNING

Unless otherwise stated, a ground connection on the instrument's front or rear panel is for a reference of potential only and is not to be used as a safety ground. Do not operate in an explosive or flammable atmosphere.

Environmental Conditions

This instrument is intended to be used in an indoor pollution degree 2 environment. The operating temperature range is 0°C to 40°C and 20% to 80% relative humidity, with no condensation allowed.

Measurements made by this instrument may be outside specifications if the instrument is used in non-office-type environments. Such environments may include rapid temperature or humidity changes, sunlight, vibration and/or mechanical shocks, acoustic noise, electrical noise, strong electric fields, or strong magnetic fields.

⚠ WARNING

Do not operate the instrument in the presence of flammable gases or vapors, fumes, or finely-divided particulates.

The instrument is designed to be used in office-type indoor environments. Do not operate the instrument

- **In the presence of noxious, corrosive, or flammable fumes, gases, vapors, chemicals, or finely-divided particulates.**
 - **In relative humidity conditions outside the instrument's specifications.**
 - **In environments where there is a danger of any liquid being spilled on the instrument or where any liquid can condense on the instrument.**
 - **In air temperatures exceeding the specified operating temperatures.**
 - **In atmospheric pressures outside the specified altitude limits or where the surrounding gas is not air.**
 - **In environments with restricted cooling air flow, even if the air temperatures are within specifications.**
 - **In direct sunlight.**
-

⚠ WARNING

Do not operate instrument if damaged

 WARNING

If the instrument is damaged, appears to be damaged, or if any liquid, chemical, or other material gets on or inside the instrument, remove the instrument's power cord, remove the instrument from service, label it as not to be operated, and return the instrument to B&K Precision for repair. Notify B&K Precision of the nature of any contamination of the instrument.

 WARNING

Hazardous voltages may be present in unexpected locations in circuitry being tested when a fault condition in the circuit exists.

Clean the instrument only as instructed

 WARNING

Do not clean the instrument, its switches, or its terminals with contact cleaners, abrasives, lubricants, solvents, acids/bases, or other such chemicals. Clean the instrument only with a clean dry lint-free cloth or as instructed in this manual. Not for critical applications

Do not touch live circuits

Instrument covers must not be removed by operating personnel. Component replacement and internal adjustments must be made by qualified service-trained maintenance personnel who are aware of the hazards involved when the instrument's covers and shields are removed. Under certain conditions, even with the power cord removed, dangerous voltages may exist when the covers are removed.

WARNING

To avoid injuries, always disconnect the power cord from the instrument, disconnect all other connections (for example, test leads, computer interface cables, etc.), discharge all circuits, and verify there are no hazardous voltages present on any conductors by measurements with a properly-operating voltage-sensing device before touching any internal parts. Verify the voltage-sensing device is working properly before and after making the measurements by testing with known-operating voltage sources and test for both DC and AC voltages.

Do not attempt any service or adjustment unless another person capable of rendering first aid and resuscitation is present.

General Safety

WARNING

Do not insert any object into an instrument's ventilation openings or other openings.

WARNING

This instrument is not authorized for use in contact with the human body or for use as a component in a life-support device or system.

Servicing

WARNING

Do not substitute parts that are not approved by B&K Precision or modify this instrument. Return the instrument to B&K Precision for service and repair to ensure that safety and performance features are maintained.

WARNING

Fuse replacement must be done by qualified service-trained maintenance personnel who are aware of the instrument's fuse requirements and safe replacement procedures. Disconnect the instrument from the power line before replacing fuses. Replace fuses only with new fuses of the fuse types, voltage ratings, and current ratings specified in this manual or on the back of the instrument. Failure to do so may damage the instrument, lead to a safety hazard, or cause a fire. Failure to use the specified fuses will void the warranty.

For continued safe use of the instrument

- Do not place heavy objects on the instrument.
- Do not obstruct cooling air flow to the instrument.
- Do not place a hot soldering iron on the instrument.
- Do not pull the instrument with the power cord, connected probe, or connected test lead.
- Do not move the instrument when a probe is connected to a circuit being tested.

Compliance Statements

Disposal of Old Electrical & Electronic Equipment (Applicable in the European Union and other European countries with separate collection systems)



This product is subject to Directive 2002/96/EC of the European Parliament and the Council of the European Union on waste electrical and electronic equipment (WEEE), and in jurisdictions adopting that Directive, is marked as being put on the market after August 13, 2005, and should not be disposed of as unsorted municipal waste. Please utilize your local WEEE collection facilities in the disposition of this product and otherwise observe all applicable requirements.



Safety Symbols











Symbol	Description
	Indicates a hazardous situation which, if not avoided, could result in death or serious injury.
	Indicates a hazardous situation which, if not avoided, will result in minor or moderate injury.
	Refer to the text near the symbol.
	Electric Shock hazard
	Alternating current (AC)
	Chassis ground
	Earth ground
	Indicates the In position of the power switch when instrument is ON.
	Indicates the Out position of the power switch when instrument is OFF.
	Indicates practices not related to physical injury.

Table 1 Safety Symbols

Contents

1	Introduction	13
1.1	Product Overview	13
1.2	Contents	14
1.3	Features	14
1.4	Dimensions	15
1.5	Rackmount Installation	16
1.6	Front Panel	17
1.7	Display	18
1.8	Rear Panel	19
2	Getting Started	20
2.1	Input Power and Fuse Requirements	20
2.2	Fuse Requirements	21
2.3	Check or Replace Fuse	21
2.4	Preliminary Check	23
2.5	Self test Errors	24
3	Basic Front Panel Operation	25
3.1	Keys	25
3.1.1	Function Keys	25
3.1.2	Soft Keys	26
3.1.3	Numeric Keys	26
3.1.4	Output Control	26
3.2	Display	27
3.3	Check Model and Firmware Version	30
3.4	Setting Voltage and Current	30
4	Output Configuration	31
4.1	Protection Settings	31
4.1.1	Over Voltage Protection (OVP)	31
4.1.2	Over Current Protection (OCP)	31
4.1.3	Over Temperature Protection & Over Temperature Warning (OTP & OTW)	31
4.1.4	Vmax/Vmin	32
4.1.5	Protection Clear	32
4.2	Output Settings	32
4.2.1	Remote Sense	32
4.2.2	Output Timer	33
4.2.3	Voltage Slew	34
4.2.4	Current Slew	34

4.2.5	On/Off Delay	34
4.2.6	LED Mode	35
5	List Mode	37
5.1	List Setup	37
5.1.1	List State:	37
5.1.2	List Number:	38
5.1.3	Pace:	38
5.1.4	Trigger Source	38
5.1.5	After List	39
5.2	Edit List	40
5.2.1	Load/Save List	40
5.2.2	List Number	41
5.2.3	Next	41
5.2.4	Repeat	42
5.2.5	Steps	42
5.3	List Run	44
6	Battery Charge Function	46
6.1	Charge Test	46
6.1.1	Start/Stop Test	46
6.1.2	Save/Load Profile	47
6.1.3	V Full	47
6.1.4	I Limit	48
6.1.5	I End	48
6.1.6	End Delay	48
6.2	Battery Test Settings	49
6.2.1	Sampling Time	49
6.2.2	A-h On/Off	49
6.2.3	W-h On/Off	49
6.2.4	Trigger Source	49
6.2.5	File Path	50
6.2.6	T. Stamp Filename	50
6.3	Fail Safe Settings	51
6.3.1	Fail State	51
6.3.2	Stop Time	51
6.3.3	Stop Ah	51
6.3.4	Stop Wh	52
6.3.5	Over Voltage Protection (OVP)	52
7	Data Logger	53
7.1	Using the Data Logger Function	53
7.2	Parameters	54
7.2.1	Sampling Interval	54

7.2.2	File Path	54
7.2.3	T. Stamp Filename	54
7.2.4	Log Data	55
7.2.5	Status Code	56
7.2.6	Trigger Source	56
7.2.7	Datalog Start/Stop	57
8	Utilities Menu	58
8.1	User Settings	58
8.1.1	Key Lock Output	58
8.1.2	Beep Sound	58
8.1.3	Date	59
8.1.4	Time	59
8.1.5	Screen Intensity	59
8.1.6	Language	59
8.2	Remote Interface	59
8.2.1	USB Settings	60
8.2.2	LAN	61
8.3	GPIB (optional)	66
8.4	Digital I/O	67
8.4.1	Functions	68
8.4.1	Polarity	69
8.4.1	Inhibit Mode	69
8.5	Test/Admin	70
8.5.1	Self Test	70
8.5.2	Security	71
8.5.3	Lock	72
8.5.4	Change Code	72
8.5.5	Calibrate	72
8.5.6	Firmware Update	72
8.5.7	NISPOM	72
8.5.8	Restore FAC. CAL.	72
8.5.9	Factory Reset	73
8.5.10	Load Help file	73
8.6	Error Log	74
8.7	Help	75
8.8	On Screen Help	76
9	Key Lock	77
10	Save/Recall	78
10.1	Save the Output Settings	78
10.1.1	Save to Internal Memory	78
10.1.2	Save to USB	78

10.2	Recall the Instrument's Settings	79
10.2.1	Recall from USB	79
10.3	Screenshot	80
10.4	Power-On Settings	81
11	Calibration Adjustment Procedure	85
11.1	Voltage Calibration Adjustment	86
11.2	Current Calibration Adjustment	87
11.3	OVP Calibration Adjustment	88
11.4	OCP Calibration Adjustment	89
11.5	RTC Calibration Adjustment	90
12	Performance Verification	91
13	Service Information	94
14	LIMITED THREE-YEAR WARRANTY	95

Introduction

1.1 Product Overview



9240: 32 V / 8 A / 120 W

9241: 60 V / 4 A / 120 W

Figure 1.1 Front View

The 9240 series multi-range DC power supplies combine industry-leading power density and performance with an extensive set of features in a compact 2U form factor.

The series produces 120/200 W of clean power with exceptionally low ripple and noise characteristics. An advanced list mode programming, data logging, battery charging and protection features make these power supplies suitable for a wide range of benchtop or test system applications.

Model	9240	9241	9242
Voltage Range	0 to 32 V	0 to 60 V	0 to 60 V
Current Range	0 to 8 A	0 to 4 A	0 to 10 A
Maximum Power	120 W		200 W

Table 1.1 Models

1.2 Contents

Please inspect the instrument mechanically and electrically upon receiving it. Unpack all items from the shipping carton, and check for any obvious signs of physical damage that may have occurred during transportation. Report any damage to the shipping agent immediately. Save the original packing carton for possible future reshipment. Every power supply is shipped with the following contents:

- 1 x 9240, 9241, or 9242 Power Supply
- 1 x AC Power Cord
- 1 x Certificate of Calibration
- 1 x Test Report

NOTICE

Ensure the presence of all the items above.
Contact the distributor or B&K Precision if anything is missing.

1.3 Features

- Compact 2U half-rack form factor
- Multi-ranging operation delivers rated power at various voltage/current combinations
- Advanced list mode programming with internal storage for up to 10 list mode programs and list sequencing capabilities
- Digital I/O block offers external triggering, voltage fault and remote inhibit capabilities
- Battery Charge Function
- Overvoltage protection (OVP), overcurrent (OCP), over temperature (OTP), and includes a key-lock function
- NISPOM Sanitization - Full memory wipe (settings and list memory, including erasing help files and hex files).
- USB (USBTMC-compliant) and LXI compliant LAN interfaces standard, GPIB optional
- LabVIEWTM, IVI-C, and IVI.NET drivers provided

1.4 Dimensions

The 9240 Series dimensions are approximately:

213 mm (8.4 in) x 88.2 mm (3.47 in) x 330 mm (13 in) (W x H x D).



Figure 1.2 Dimensions

1.5 Rackmount Installation

The 9240 Series is compatible with the optional 19-inch rackmount kit model RK2US. The RK2US installation instructions can be downloaded from bkprecision.com



Figure 1.3 Dimensions

1.6 Front Panel



Figure 1.4 Front Panel

Item	Name	Description
1	Power Button	Power the instrument ON or OFF
2	Function Keys	See section 3.1.1 for details.
3	USB Host Port	USB port used to connect flash drives.
4	Display	Visual presentation of the device function and measurements.
5	Numeric Keypad	Used to enter precise values.
6	Rotary Knob	Used to navigate menus or configure parameters.
7	Output/Sense	Isolated and floating output channel supporting sheathed banana plugs and spade lug type connectors
8	Soft Keys	Used to invoke any functions displayed above them.

Table 1.2 Front Panel

1.7 Display

















Icon	Description
	The output is disabled.
	The output is enabled and in constant voltage mode
	The output is enabled and in constant current mode
	Data logging is enabled but not recording.
	Data logging is enabled and recording.
	
	The instrument is connected to a network.
	An issue occurred when attempting to connect to a network.
	The instrument is not connected to a network.
	All keys excluding softkey F6 are locked.
	Over voltage protection was triggered.
	Over current protection was triggered.
	Over temperature protection was triggered.
	The instrument is set to remote mode
	Remote sense is enabled.
	Remote

Table 1.3 Display Icons

1.8 Rear Panel



Figure 1.5 Rear Panel

Item	Name	Description
1	Output/Sense	Rear panel output with remote sense. Internal relays switch between local and remote sensing.
2	Kensington security slot	Lock the instrument to a fixed location using the security lock via the lock hole. Lock is not included.
3	GPIB Interface (Optional)	Connect a GPIB cable to remotely control the unit `
4	Digital I/O	Send or receive a signal to or from an external device.
5	USB interface	Connect a USB type B to type A to remotely control the unit.
6	LAN interface	Connect a Cat 5/6 Ethernet straight-through patch cable to remotely control the unit.
7	Chassis ground	Provides a zero potential voltage reference and a dissipation point for interference, transient voltages and static.
8	AC power input & fuse box	Houses the fuse as well as the AC input.

Table 1.4 Rear Panel

Getting Started

Before connecting and powering up the instrument, please review and go through the instructions in this chapter.

2.1 Input Power and Fuse Requirements

The supply has a universal AC input that accepts line voltage input within:

	9240	9241	9242
AC Line Input	100 - 240 VAC \pm 10%, 47 to 63 Hz		
AC Line Phase	Single Phase		
Maximum Rated Input Power	200 VA		300 VA

Before connecting to an AC outlet or external power source, be sure that the power switch is in the OFF position and verify that the AC power cord, including the extension line, is compatible with the rated voltage/current and that there is sufficient circuit capacity for the power supply. Once verified, connect the cable firmly.

WARNING

The included AC power cord is safety certified for this instrument operating in rated range. To change a cable or add an extension cable, be sure that it can meet the required power ratings for this instrument. Any misuse with wrong or unsafe cables will void the warranty.



The power cord provides a chassis ground through a third conductor. Verify that your power outlet is of the three-conductor type with the correct pin connected to earth ground.

2.2 Fuse Requirements

An AC input fuse is necessary when powering the instrument. The below table shows the fuse required for all models.

Model	Fuse Specification
9240	3.15 AT, 250 V
9241	3.15 AT, 250 V
9242	4 AT, 250 V

2.3 Check or Replace Fuse



WARNING

For safety, no power should be applied to the instrument while changing line voltage operation. Disconnect all cables connected to the instrument before proceeding.

1. Locate the fuse box next to the AC input connector in the rear panel. (See figure 1.5)
2. Insert a small flathead screwdriver into the fuse box slit to pull and slide out the fuse box.
3. Check and replace fuse if necessary. (See figure 2.1)

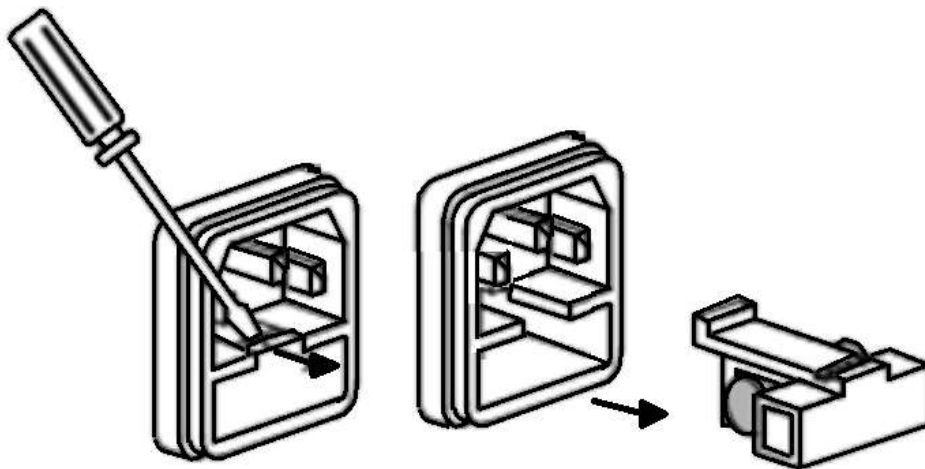
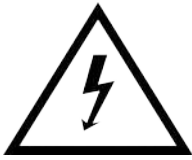

Figure 2.1 Fuse Removal

⚠ WARNING

Any disassembling of the case or changing the fuse not performed by an authorized service technician will void the warranty of the instrument



Hazardous voltages may exist at the outputs and the load connections when using a power supply with a rated output greater than 60 V. To protect personnel against accidental contact with hazardous voltages, ensure that the load and its connections have no accessible live parts. Ensure that the load wiring insulation rating is greater than to the maximum output voltage of the power supply.

The rear output terminals can accept wire sizes AWG 24 to AWG 12 (See [Table 2.1](#)). However, we recommend using 12 AWG if current output is between 5 to 10 A. Refer to Table 2 below to determine the proper wire size.

Wire Gauge Rating										
AWG	10	12	14	16	18	20	22	24	26	28
I_{max} (A)	40	25	20	13	10	7	5	3.5	2.5	1.7
mΩ/meter	3.3	5.2	8.3	13.2	21	33.5	52.8	84.3	133.9	212.9

Table 2.1 Wire Gauge Rating

Output Isolation

The output terminals of the 9240 Series are isolated from earth ground. An earth ground terminal is provided on the front panel for convenience. Any output terminal may be grounded. However, output terminals must not exceed ±200 VDC.



Floating voltage must not exceed 200 VDC.

2.4 Preliminary Check

Complete the following steps to verify the Power supply is ready for use.

**Verify AC
Input Voltage**

Verify and check to make sure proper AC voltages are available to power the instrument. The AC voltage range must meet the acceptable specification as explained in section “**2.1 Input Power and Fuse Requirements**”.

**Connect Power
& Self-Test**

Connect AC power cord to the AC receptacle in the rear panel and press the power button. It will run through a self-test procedure initially before booting to the main screen.

After Power on, during the self-test, the following should be displayed:

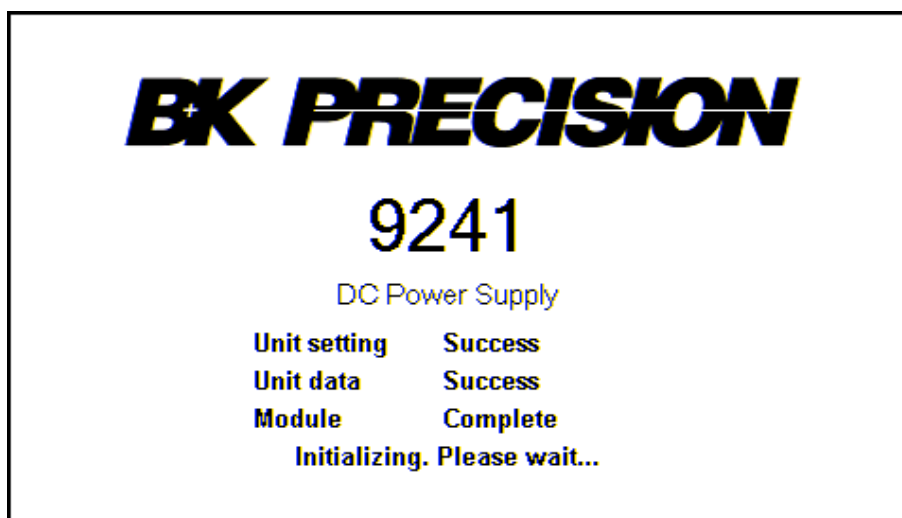

Figure 2.2 Initializing

After the system scan is complete the LCD will display as shown in **Figure 2.3**

NOTICE

The initial power on state is based on the settings set on **Power-ON**



Figure 2.3 Home Display

2.5 Self test Errors

The following errors will be displayed if the self-test did not complete successfully:

Error Message	Description
EEPROM Fail	The internal EEPROM is corrupted or damaged.
System Lost	Last system settings within the EEPROM are lost.
Module Fail	Channel response failure.
Cal Lost	Calibration data within the EEPROM is lost.
Fact Loss	Factory calibration data is lost.
Model Lost	Channel initialization failed.

Table 2.2 Error Message

NOTICE

If any of these errors occur, please contact B&K Precision.

Basic Front Panel Operation

At power-on, the power supply will automatically enter the front-panel operation mode and the instrument can be controlled via the front panel keys and knob.

3.1 Keys

3.1.1 Function Keys

There are three main keys:



Navigates the 2 available screens. When navigating any menu the key will return to the main display.

2 available displays:

- **Main page:**
Overview of the output.
- **Live Output Monitoring:**
Oscilloscope like overview of the measured output parameters.



Opens up a menu giving access to various save and load options, regardless of the current display of the screen.



Opens the main menu bar. Pressing **Utility** will navigate to the main menu bar if any menu bar is already open.

3.1.2 Soft Keys

The unit has six soft keys, which are located beneath the screen. Each key selects the corresponding function. Functions will vary depending on the current menu or display.



Figure 3.1 Soft Keys

3.1.3 Numeric Keys

The numeric keys allow the configuration of various parameters. Using the numeric keys provides a fast and precise input. The **Enter** key can be found with the numeric keys. Pressing enter will assign the selected value to the desired parameter.



Figure 3.2 Numeric Keys

3.1.4 Output Control

The **ON** button toggles the output On/Off. When output is enabled, the ON button will turn green **ON** and the supply will display the state of the channel.

CC represents constant current mode. **CV** represents constant voltage mode. When output is disabled, the channel state will display **OFF**.

3.2 Display

The power supplies have two main display modes: output overview and live output monitoring display.

Press the  button to cycle between the different display modes or to return home when viewing any other menu.

Output Overview

Provides information of the outputs':

- State
- Run time
- Voltage
- Current
- Power
- Vmax/Vmin
- OVP/OCP
- OnDelay/OffDelay

Allows configuration of:

- Vset
- Iset
- Vmax/Vmin
- OVP/OCP
- OnDelay/OffDelay

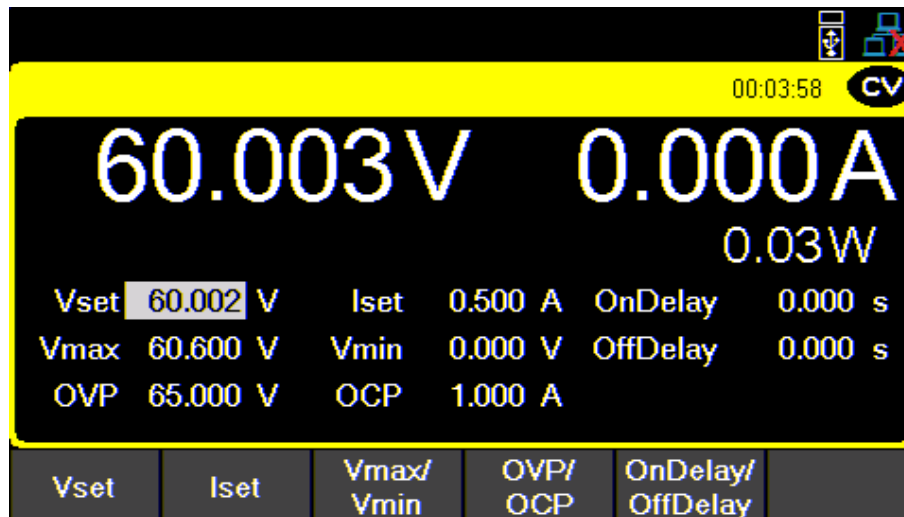

Figure 3.3 Output Overview Display

Live Output Monitoring

The live output monitoring display shows metered output voltage and current over time. It is always active and will continuously plot and overwrite the oldest value when the display graph is full.

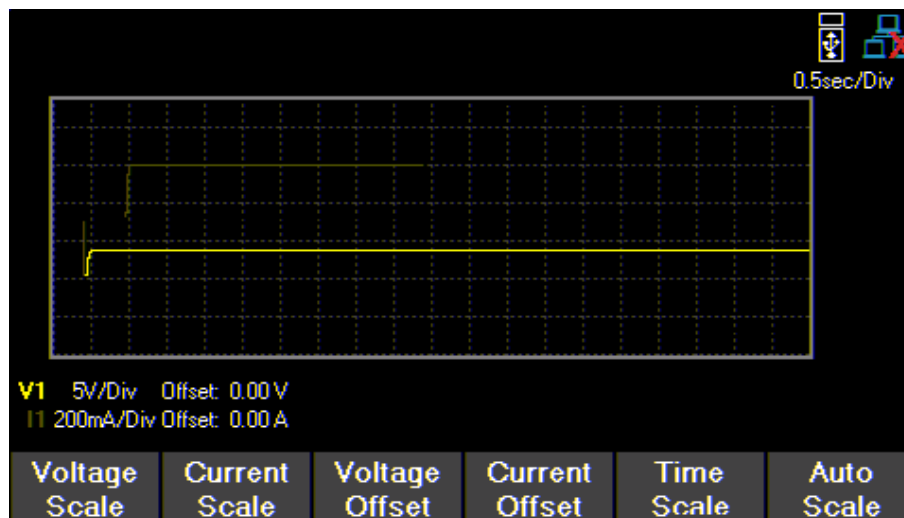

Figure 3.4 Live Output Monitoring Display

The Live output display can be configured by setting the: Voltage, Current, and Time Scale.

Voltage Scale

The voltage scale of each output can be set from 10 mV/Div up to 20 V/Div.

1. While in **Live Output Display** use the softkeys to select **Voltage Scale**.
2. Select a channel to configure.

3. Use the rotary knob to navigate through the available scales.

Current Scale

The current scale of each output can be set from 10 mA/Div up to 3 A/Div.

1. While in **Live Output Display** use the softkeys to select **Current Scale**.
2. Select a channel to configure.
3. Use the rotary knob to navigate through the available scales.

Time Scale

The time scale of each output can be set from 1 s/Div up to 10 min/Div.

1. While in **Live Output Display** use the softkeys to select **Time Scale**.
2. Use the rotary knob to navigate through the available scales.

Voltage Offset

A voltage offset can be added.

The offset can be set from 0 V up to 32.2 V on the 9240 and 0 V up to 60.6 V on the 9241/9242.

1. While in **Live Output Display** use the softkeys to select **Voltage Offset**.
2. Select a channel to configure.
3. Use the rotary knob to navigate through the available scales.

Current Offset

A current offset can be added to each output.

The offset can be set from 0 A up to 8.08 A on the 92400 A, from 0 to 4.04 A on the 9241, and 0 to 10.1 A on the 9242.



1. While in **Live Output Display** use the softkeys to select **Current Offset**.
2. Select a channel to configure.
3. Use the rotary knob to navigate through the available scales.

3.3 Check Model and Firmware Version

The firmware version, model, and serial number can be verified by entering the security settings. Press  button then use the soft keys to select Utilities > Help > System Info to view model and firmware information.

3.4 Setting Voltage and Current

Follow the steps below to set the output voltage or current. The values can be entered using the numeric keypad or the rotary knob.

1. Using the keypad: Use the soft keys to select the channel VSET or ISET settings beneath channel view on the display. Then use the numeric keypad to input the voltage or current value then press  to confirm.
2. Using the rotary knob: Use the soft keys to select the channel VSET or ISET settings beneath the channel view on display. Then turn the knob clockwise to increment or counter-clockwise to decrement the value. Use the   below the rotary knob to move the cursor. Press the knob in to confirm.

Output Configuration

4.1 Protection Settings

4.1.1 Over Voltage Protection (OVP)

Over voltage protection is always enabled, however the user can set the OVP voltage limits.

1. Press the **Utility** button then use the soft keys to select **Output config > Protection settings**
2. Select **OVP Limit**.
3. Use the numeric keypad or rotary knob to set the desired OVP limit.

When OVP protection is tripped during operation, the output will be de-rated to 0 V and the icon  will appear between the wattage and Vset.

4.1.2 Over Current Protection (OCP)

Over current protection state and limit can be set in the protection settings.

1. Press the **Utility** button then use the soft keys to select **Output config > Protection settings**
2. Press **OCP State** to toggle the over current protection on or off.
3. Select **OCP Limit** and use the numeric keypad or rotary knob to set limit value.

When OCP protection is tripped during operation, the output will be de-rated to 0 V and the icon  will appear between the wattage and Vset.

4.1.3 Over Temperature Protection & Over Temperature Warning (OTP & OTW)

The state and limit of both OTP & OTW cannot be set or configured in the protection settings. OTP is set to 85 °C and OTW is set to 75 °C. If the temperature reaches either OTW, the OT icon will blink on the display with a low period beep sound. If temperature reaches OTP the OT icon will show on the display and the output will turn off. The output will not be allowed to turn on until the temperature drops to 75 °C.

Fan Speed Control	
2 A	0%
2 to 5 A	25%
5 A	100%

Table 4.1 Fan Control

4.1.4 Vmax/Vmin

Configure the maximum or minimum voltage value the user can set from the protection settings.

1. Press the **Utility** button then use the soft keys to select **Output config > Protection settings**
2. Select **Vmax** or **Vmin** and set a maximum or minimum value using the numeric keypad or rotary knob.

4.1.5 Protection Clear

Protections are cleared from the output configuration settings as shown in the following steps.

1. Press the **Utility** button then use the soft key to select **Output config > Protection Clear**.
2. Press the soft key to clear the triggered protections.

4.2 Output Settings

4.2.1 Remote Sense

Remote sense can be used to compensate for voltage drops (up to 1 V) due to resistance from test leads connected to your device under test (DUT), thus providing more accurate output voltage. When remote sense is enabled, the positive (+S) and positive lead (+) of the DC output are connected to the positive (+) of the load. Similarly, the negative sense (-S) and negative lead (-) of the DC output are connected to the negative (-) end of the load shown in the figures below.

The sense terminals and output terminals are shorted by the shorting bar provided.

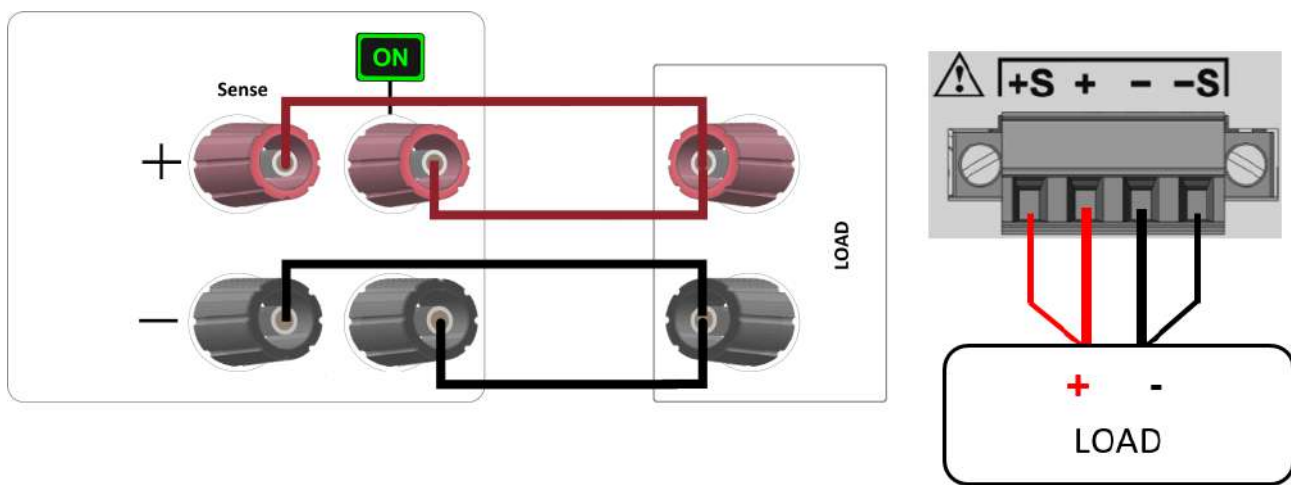

Do not connect any power source into any of the terminals at any time during operation.

⚠ WARNING

When output is enabled, DO NOT use your hands to touch the terminals or the screws that are designed to tighten wires to the terminals. Doing so may create a shock hazard under high voltage output conditions.

⚠ CAUTION

DO NOT at any time disconnect the wires from the S+ and S- terminals to the DUT while output is enabled (ON). Doing so may damage the power supply and cause unstable output.

Remote sense is disabled by default, to enable remote sense:

1. Press the  button then use the soft key to select **Output config > Output Settings**.
2. Press **Remote Sense** using the soft key to enable remote sense.

4.2.2 Output Timer

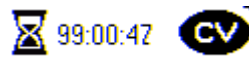

An output timer can be set. When the output timer is enabled, an hourglass icon will be displayed next to the output state icon. The timer countdown will begin when the output is enabled. The output is disabled when the countdown reaches 0. The timer can be set from 1 second to 99 hours 59 minutes and 59 seconds.

Follow the steps below to enable and set the output timer:

1. Press the  button then use the soft key to select **Output config > Output Settings**.
2. Push **Timer State** to enable the timer.
3. Select **Timer Setting** and set a desired time for the output to be enabled using the numeric keypad or rotary knob. The timer format is: HH:MM:SS. Use the keys to move the cursor.

4.2.3 Voltage Slew

The rising voltage slew rate can be set in volts per second. The voltage slew range can be set from 0.001 V/s to 3200.0 V/s.

1. Press the **Utility** button then use the soft key to select **Output config > Output Settings**.
2. Select Voltage Slew and use the numeric keypad or rotary knob to adjust the slew rate value. Press to confirm input.

4.2.4 Current Slew

The rising current slew rate can be set in amps per second. The current slew range can be set from 1 A/s to 800 A/s.

1. Press the **Utility** button then use the soft key to select **Output config > Output Settings**.
2. Select **Next Pg. > Current Slew** and use the numeric keypad or rotary knob to adjust the slew rate value.
Press **Enter** to confirm input.

4.2.5 On/Off Delay

A channel on or off delay in seconds can be applied to any channel. These delays can be set from 0.001 s to 3600.0 s.

1. Press the **Utility** button then use the soft key to select **Output config > Output Settings**.
2. Select Next Pg. > On Delay to set an on delay or Off Delay to set an off delay.
3. Use the numeric keypad or rotary knob to adjust the delay value. Press **Enter** to confirm input.

4.2.6 LED Mode

The 9240 series offer the LED mode, which enables them to function specifically for LED test applications. When this mode is Enabled, the power supply can operate in such a way as to minimize or almost eliminate the inrush current drawn by the LED load, which normally exists when the output swithes from an OFF state to an ON state.

To Enable **LED Mode**:

1. Press the **Utility** button then use the soft key to select **Output config > Output Settings**.
2. Press the **F6** softkey to select **Next Pg. >**
3. Press the **F5** softkey to toggle **LED Mode ON/Off**.

Example

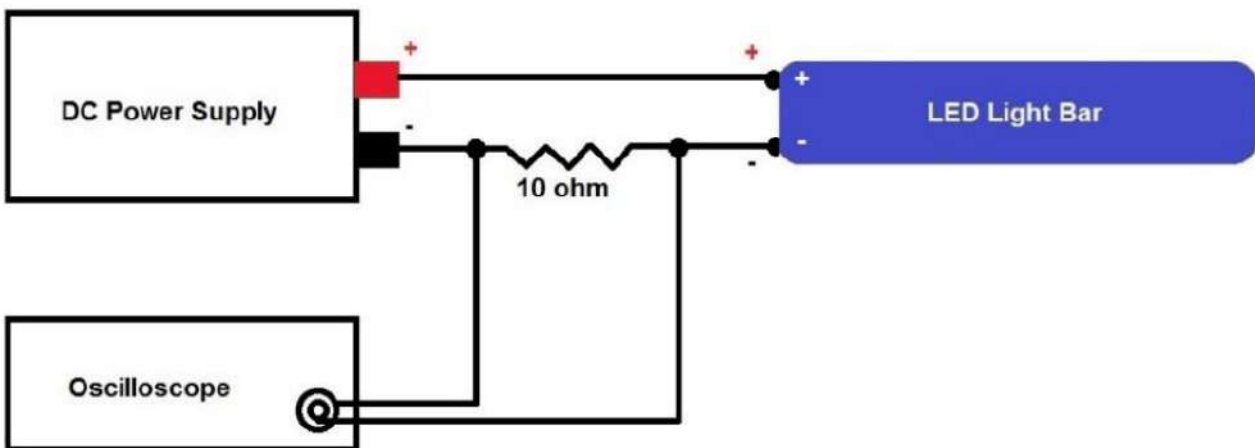

Figure 4.1 LED Testing Example

The 9240 output is initially OFF (disabled). The LED light bar is rated for 60 V. A 10 Ω resistor is placed in series with the LED light bar. The power supply current setting (ISET) is 20 mA. Using an oscilloscope to probe between the resistor to measure current, the power supply's output is then turned ON. The measured results are shown in **Figure 4.2**, which compares the measured results with and without LED mode ON (enabled).

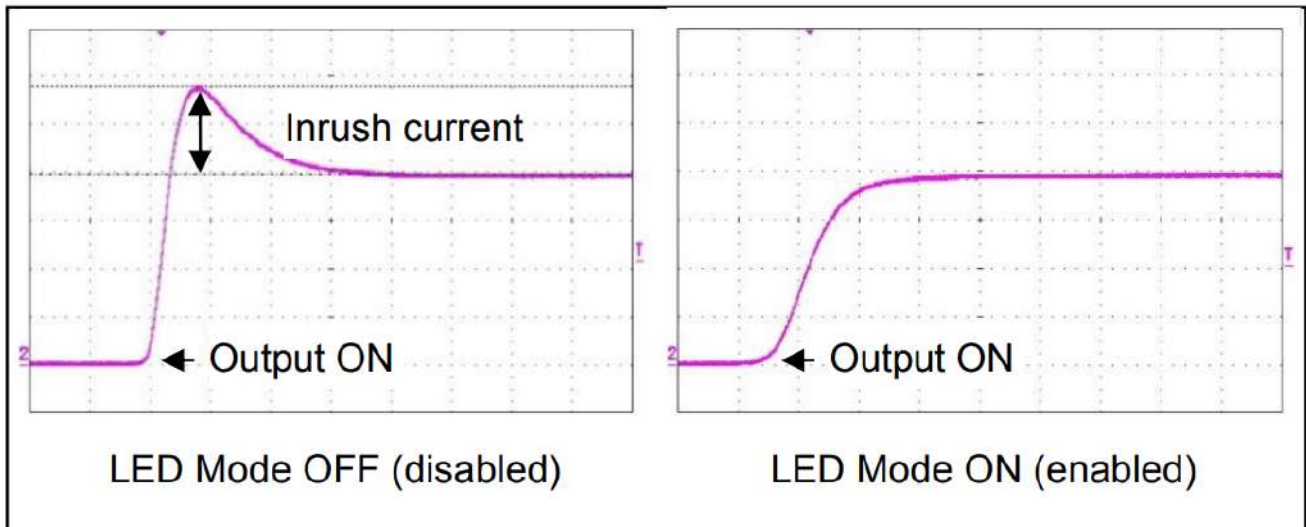

Figure 4.2 Inrush Current With and Without LED Mode Enabled

With LED mode ON (enabled), the power supply can minimize or eliminate any inrush current from turning the output ON, which in turn will minimize damage or life of the LEDs under test.

NOTICE

For LED mode to function correctly, the output must be turned OFF when connecting between the power supply and the LEDs under test. Turn ON the output after LED mode is enabled and all other settings are configured.

List Mode

The 9240 series is capable of storing up to 10 programmable lists in the internal memory. Each list can have up to 100 configurable steps.

If all ten list numbers are taken, a list can also be saved to a USB drive. Lists can be loaded from a USB drive, allowing for a larger collection of programmed lists.

5.1 List Setup

Press the **Utility** button then use the soft key to select **List/Battery > List Setup**.

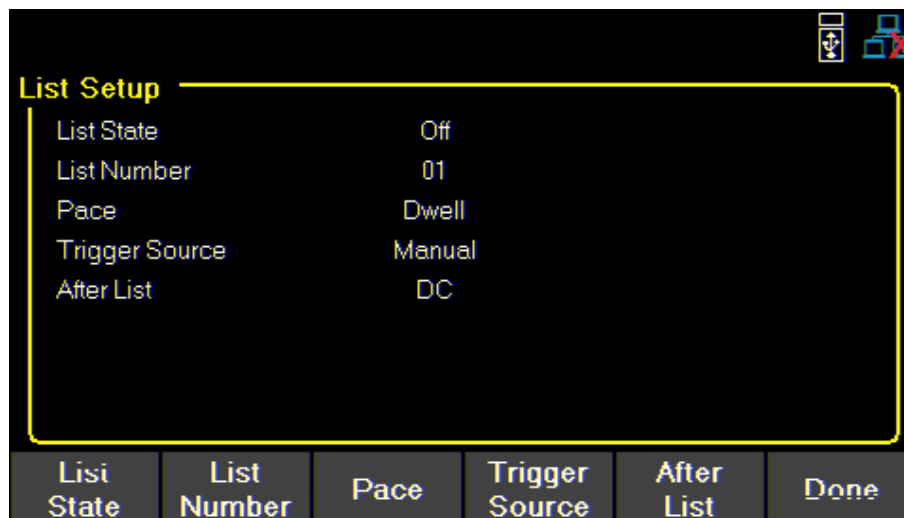

Figure 5.1 List Setup

Use the softkeys to set the following parameters.



5.1.1 List State:

Toggle list state **On/Off** for the selected channel.

5.1.2 List Number:

Select a list program from the memory to run on the channel.
Use the numeric keypad or rotary knob to select list number.

Press **Enter** to assign the list to a channel.

5.1.3 Pace:

Set the pace in which steps are executed.

- Dwell:** The next step outputs once the dwell time elapsed.
- Trigger:** After the dwell time elapsed, wait for a trigger before outputting the next step.

5.1.4 Trigger Source

Set the trigger source.

- Manual:** Select to use a manual trigger. The **Trigger** softkey will be available once **List State** is on and exit out of the menu to the main display. Press it to manually trigger the list program. If the step dwell time has not elapsed, then **Trigger** will not have a white background. When dwell time elapses, **Trigger** background color will turn white to indicate the trigger is ready.

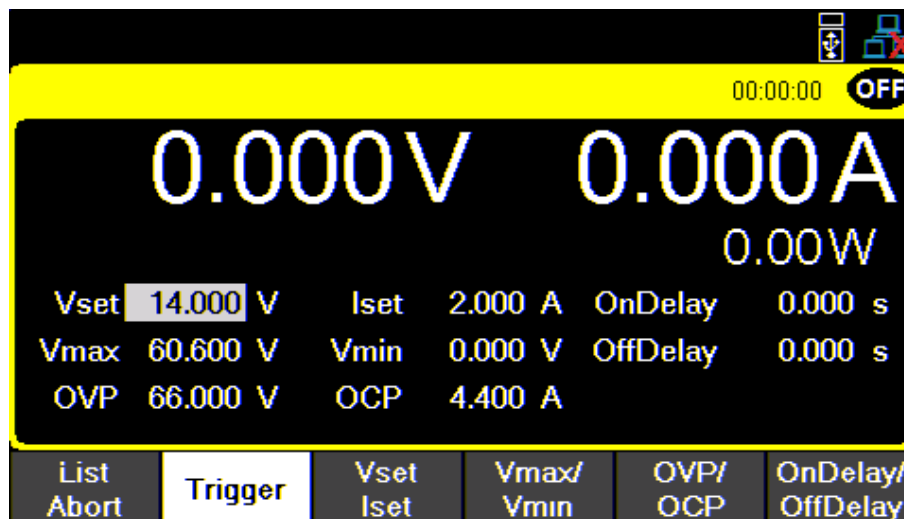
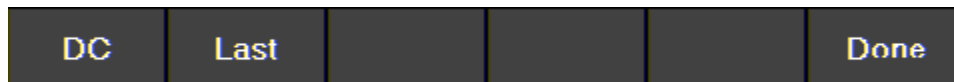

Figure 5.2 Waiting for Trigger

- Digital IO:** Select to use the digital I/O pins to receive a trigger. To assign trigger input function to a pin see [8.4.1](#).
- Remote:** Select to receive a trigger from the remote interface.

5.1.5 After List

Sets the voltage and current settings at the end of the list program.



- a. **DC:** Returns to the last DC output voltage and current setting prior to enabling list mode.
- b. **Last:** Retains the last step voltage and current setting after the list program ends.

NOTICE

If the list is aborted, the output will return to the last set voltage and current output values before the list began, even if **After List** is set to **Last**.

5.2 Edit List

Press the **Utility** button then use the soft key to select **List Setup > Edit List**.

Use the softkeys to set the following parameters.



5.2.1 Load/Save List

Save to USB

Save the selected list program to a USB.

Use the rotary knob to navigate through the file paths of the USB. Use the **Enter** button to expand folders. Once the desired location has been found select **Save** by pressing the softkey furthest to the left.



Figure 5.3 Save to USB

Load from USB

Load a previously saved list from a USB to selected **List Number**.

Use the rotary knob to navigate through the file paths of the USB. Use the **Enter** button to expand folders. Once the desired location has been found select **Load** by pressing the softkey furthest to the left.



Figure 5.4 Load from USB

NOTICE

The list must be saved/overwritten at the selected list number location before it is able to be assigned.

5.2.2 List Number

Select a list program from the internal memory by using the numeric keypad or rotary knob. The instrument supports 10 list programs (0 to 9).

Press the **Enter** button to assign the list.

5.2.3 Next

Set the next list program to run after the current list elapse.

- To make a list run continuously and indefinitely, set **Next** to the same number as **List Number**.
- To run different list sequences continuously, set **Next** to each other.

Example

- Set **Next** on List 1 to 2.
- Set **Next** on List 2 to 1.

5.2.4 Repeat

To repeat a list, set **Repeat** using the numeric keypad or rotary knob and press **Enter**.

5.2.5 Steps

Add, delete, clear all, or edit steps.

Add Step

Use the softkeys to add a step to the list. The step added will be a duplication of the step selected before pressing **Add Step**.

To select a step to duplicate, use the rotary knob to navigate the available steps. If the list is new, only one default step will be available. Pressing **Add Step** will duplicate the default step.

Step	Voltage	Current	BOST	EOST	Dwell
1	0.000	0.015			0.1

Load/Save List List Number Next Repeat Steps Done

Figure 5.5 Default Step In New List

Delete Step

Delete the step selected before pressing **Delete Step**.

Use the rotary knob to navigate between each step.

Clear All

Clear all list parameters. See fig 5.5

Edit Step

Use the rotary knob to navigate the steps available.(select a row)

To edit parameters of the step, use the ◀ ▶ keys.(selects a column)

See figure 5.6 for the parameter each row edits.

Press **Enter** to toggle enable/disable BOST and/or EOST.



Figure 5.6 List Configuration

Step Parameters	Description
Voltage	Set the Vset value.
Current	Set the Iset value.
BOST	Press the knob or the Enter button to enable/disable a trigger-out signal at the beginning of the step (BOST).
EOST	Press the knob or the Enter button to enable/disable a trigger-out signal at the end of the step (EOST).
Dwell	Sets the dwell time of the selected step.

Table 5.1 Step Parameters

5.3 List Run

Before running a list all list parameters must first be configured.

To configure and run a list follow the steps below:

1. Set the settings of the channel which will output the list. See [5.1](#)
 - a. Enable **List State** on desired channel.
 - b. Assign a **List Number** to the channel.
 - c. Select **Pace** { Dwell or Trigger}.
 - d. Select **Trigger Source** { Manual, Digital IO, or Remote }.
 - e. Select **After List** output {DC or Last}.
2. Configure the parameters of each step. See [section 5.2](#)
3. After configuring the list and channel parameters press  to return to the main page.
 - **List Start** will be inserted as the **F1** softkey option. All other option in the home page will move one softkey to the right. See [figure 5.7 List Idle](#).
4. Press the **F1** softkey to select **List Start** and run the assigned list program.
 - Once the list begins **List Start** will change to **Abort List** see [figure 5.7 List Running](#)
 - The interaction with the list will vary depending on the chosen **Pace**. See [5.1](#)

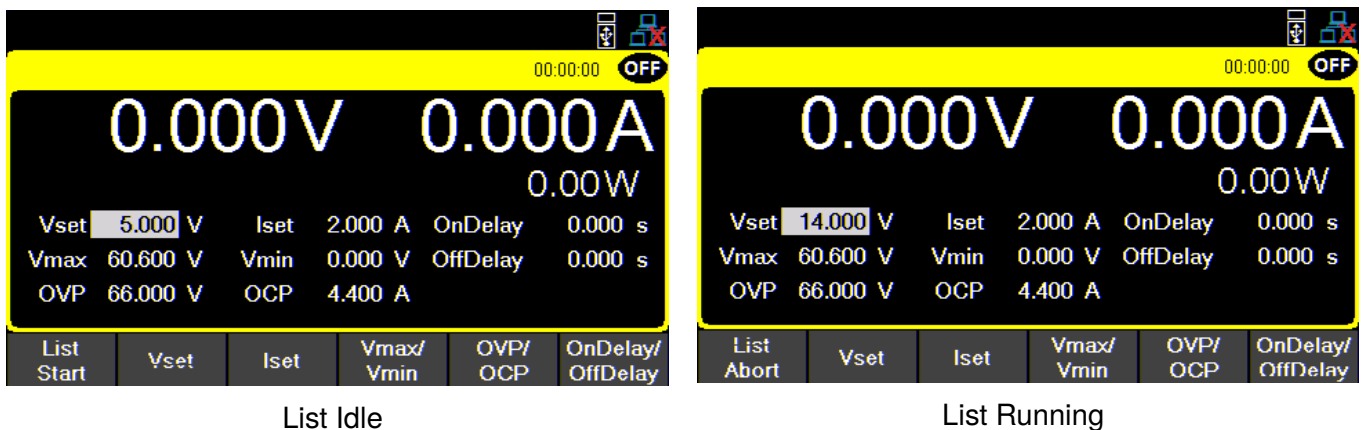

Figure 5.7 Operation State Enabled

5. Select **List Abort** to end the list before all steps elapse. If the all steps elapse the list will end and the output will be set to chosen **After List** parameter.
 - If **After List** is set to **DC** the output will output the Vset and Iset values.
 - If **After List** is set to **Last** the output will output the values of the last step in the list.

While the list is running the user can adjust the current step output by setting Vset or Iset on the main display. Doing so will immediately change the value of the ongoing output. However, the set value will not be saved to the list. Once the dwell time of the step has elapsed the list will continue and output the next step.

NOTICE

If Trigger source is set to manual, **Vset/Iset** will be available in the **F3** softkey as shown in figure 5.8. The rotary knob and numeric keypad can be used to adjust the selected value. Vset/Iset will be available as shown in figure 5.8.

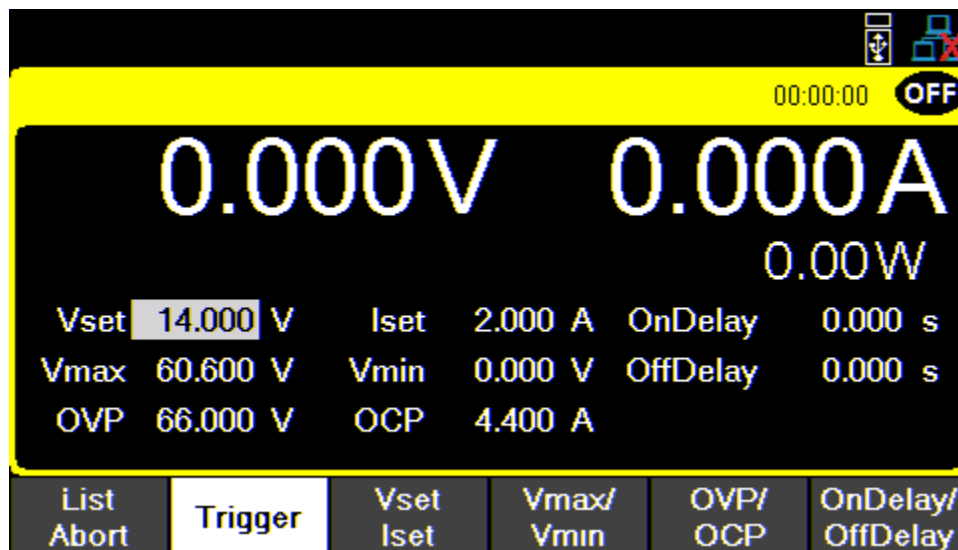

Figure 5.8 Single Channel Display Vset/Iset

Battery Charge Function

The **Battery Charge Function** can be configured to set the desired charging parameters.

6.1 Charge Test

Press the **Utility** button then use the soft key to select **List/Battery > Batt Test Setup > Charge Test**.

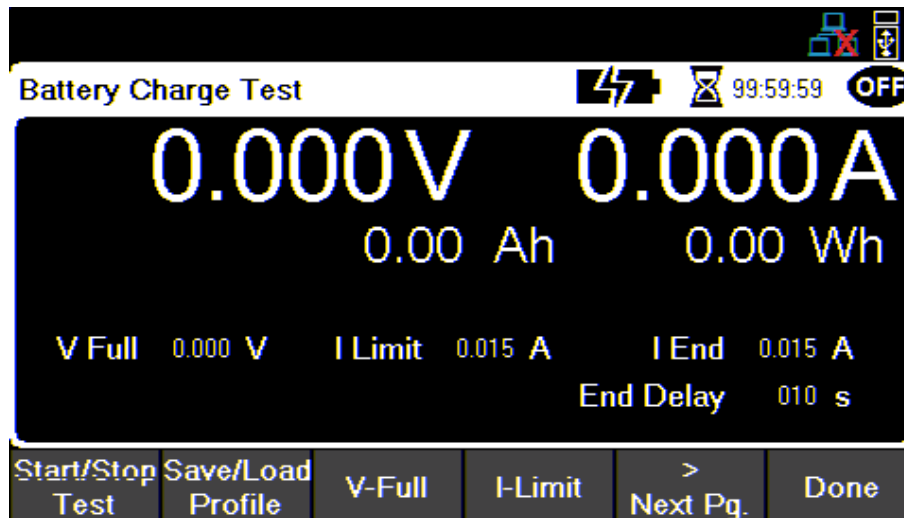

Figure 6.1 List Setup

Use the softkeys to select one of the available functions/parameters.

6.1.1 Start/Stop Test

Press the **Utility** button then use the soft key to select **List Battery > Batt Test Setup > Charge Test > Start/Stop Test**.

Press the corresponding softkey to **Start/Stop** the battery test. The battery test will not begin charging until the output is enabled.

6.1.2 Save/Load Profile

Save the set parameters of the profile to a flashdrive or load a previously saved profile from the flash drive to the 9240. The unit does not have internal memory to store more than one profile.

Press the **Utility** button then use the soft key to select **List Battery > Batt Test Setup > Charge Test > Save/Load Profile**.

- Use the corresponding softkey to select the **Save to USB** or **Load from USB** function.
- Use the rotary knob and the **Enter** key to navigate through the file path of the USB. Once the desired location has been found select **Save** or **Load** by pressing the softkey furthest to the left.

If no USB drive is inserted the following prompt will be displayed.

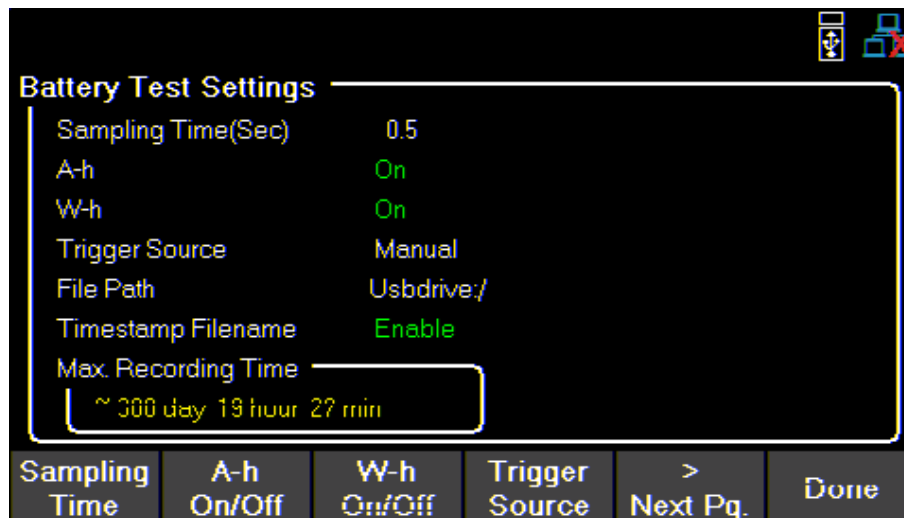

Figure 6.2 List Setup

6.1.3 V Full

Set a voltage value to be interpreted as the battery being fully charged. We recommend to set this value to 90% of the battery full capacity.

Press the **Utility** button then use the soft key to select **List Battery > Batt Test Setup > Charge Test > V-Full**.

- Use the numeric keypad or the rotary knob to enter or adjust the V Full value.
- Press the **Enter** to set the V Full value.

6.1.4 I Limit

Set a current limit value limiting the current being supplied to the battery.

Press the **Utility** button then use the soft key to select **List Battery > Batt Test Setup > Charge Test > I Limit**.

- Use the numeric keypad or the rotary knob to enter or adjust the I Limit value.
- Press the **Enter** to set the I Limit value.

6.1.5 I End

Set a current limit value to interpreted as the stop charging value of the battery.

- Use the numeric keypad or the rotary knob to enter or adjust the I End value.
- Press the **Enter** to set the I End value.

6.1.6 End Delay

Set a delay to the battery charging function once the desired parameters have been reached.

Press the **Utility** button then use the soft key to select **List Battery > Batt Test Setup > Charge Test > End Delay**.

- Use the numeric keypad or the rotary knob to enter or adjust the end delay time.
- Press the **Enter** to set the end delay time.

6.2 Battery Test Settings

6.2.1 Sampling Time

Set a time duration for the charging function.

Press the **Utility** button then use the soft key to select **List Battery > Batt Test Setup > Batt Test Settings > Sampling Time**.

Use the numeric keypad or rotary motor to select the sampling time. Press **Enter** to assign the selected value. (.5s to 300s)

6.2.2 A-h On/Off

Press the **Utility** button then use the soft key to select **List Battery > Batt Test Setup > Batt Test Settings > A-h On/Off**.

Press the corresponding softkey to toggle the recording of AH.

6.2.3 W-h On/Off

Press the **Utility** button then use the soft key to select **List Battery > Batt Test Setup > Batt Test Settings > W-h On/Off**

Press the corresponding softkey to toggle the recording of WH.

6.2.4 Trigger Source

Press the **Enter** button then use the soft key to select **List/Battery > Batt Test Setup > Batt Test Settings > Trigger Source**.

Datalog can be triggered in three ways: **Manual**, **Digital IO**, and **Remote**.

- **Manual**: Select to use manual trigger. The trigger softkey will be available as Datalog Start/Stop. See section [7.2.7](#)
- **Digital IO**: Select to use the digital I/O pins to receive a trigger. To assign a function to a pin see section [8.4.1](#).
- **Remote**: Select to receive a trigger from a remote interface.

NOTICE

For **Digital IO** and **Remote** the first trigger will turn Data log on. A second trigger will begin data recording.  will be displayed on the top right when data is being logged. See [section 7.2.7](#).

6.2.5 File Path

Press the  button then use the soft key to select **List/Battery > Batt Test Setup > Batt Test Settings > Next Pg. > File Path**.

Using the rotary knob and the  key to navigate through the file path of the USB. Once the desired location has been found select **save** by pressing the softkey furthest to the left.

Verify that the correct path was chosen in the **Data Logger** menu.



Figure 6.3 File Path Selected

6.2.6 T. Stamp Filename

Press the  button then use the soft key to select **List/Battery > Batt Test Setup > Batt Test Settings > Next Pg. > T. Stamp File**.

Press the corresponding softkey to toggle stamp filename.

Example

Disabled 9240_log
 Enabled 9240_log_20201017002307

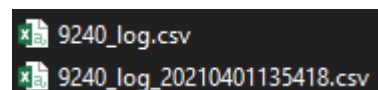

6.3 Fail Safe Settings

Enable/Disable and edit the safety parameters of the **Battery Charging Function**

6.3.1 Fail State



Press the  button then use the soft key to select **List/Battery > Batt Test Setup > Fail Safe Settings > Fail State**.

Press the corresponding softkey to toggle the battery fail state **Enable/Disable**.

6.3.2 Stop Time

Set a stop time for the charge function.

Press the  button then use the soft key to select **List/Battery > Batt Test Setup > Fail Safe Settings > Stop Time**.

- Use the numeric keypad or rotary knob to set the desired stop time.
- Use the   keys to navigate between hr:min:sec.
- Press the  to set the stop time.

Upon starting the Battery Charge function and turning on the output a timer will be set. The output will turn off once the timer reaches 0 or when another stop parameter is reached.

6.3.3 Stop Ah

Set a Ah stop time.

Press the  button then use the soft key to select **List/Battery > Batt Test Setup > Fail Safe Settings > Stop Ah**.

- Use the numeric keypad or rotary knob to set the desired stop time. (0 to 9999.99 s)
- Press the  to set the stop time.

Upon starting the Battery Charge function and turning on the output a timer will be set. The output will turn off once the timer reaches 0 or when another stop parameter is reached.

6.3.4 Stop Wh

Set a Wh stop time.

Press the  button then use the soft key to select **List/Battery > Batt Test Setup > Fail Safe Settings > Stop Wh**.

- Use the numeric keypad or rotary knob to set the desired stop time. (0 to 9999.99 s)
- Press the  to set the stop time.

Upon starting the Battery Charge function and turning on the output a timer will be set. The output will turn off once the timer reaches 0 or when another stop parameter is reached.

6.3.5 Over Voltage Protection (OVP)

Over voltage protection is always enabled, however the user can set the OVP voltage limits.

Press the  button then use the soft key to select **List/Battery > Batt Test Setup > Fail Safe Settings > OVP**.

- Use the numeric keypad or rotary knob to set the desired OVP limit.
- Press the  button to set the OVP value.

When OVP protection is tripped during operation, the output will be de-rated to 0 V and the icon  will appear.

Data Logger

The data logger can record the output voltage, current, and the error codes. The Data Logger can be configured to record either Voltage only, Current only, or both. Connect a USB flash drive to the front panel USB port. Max. Recording time will vary based on the flash drive size and the amount of the data being logged.

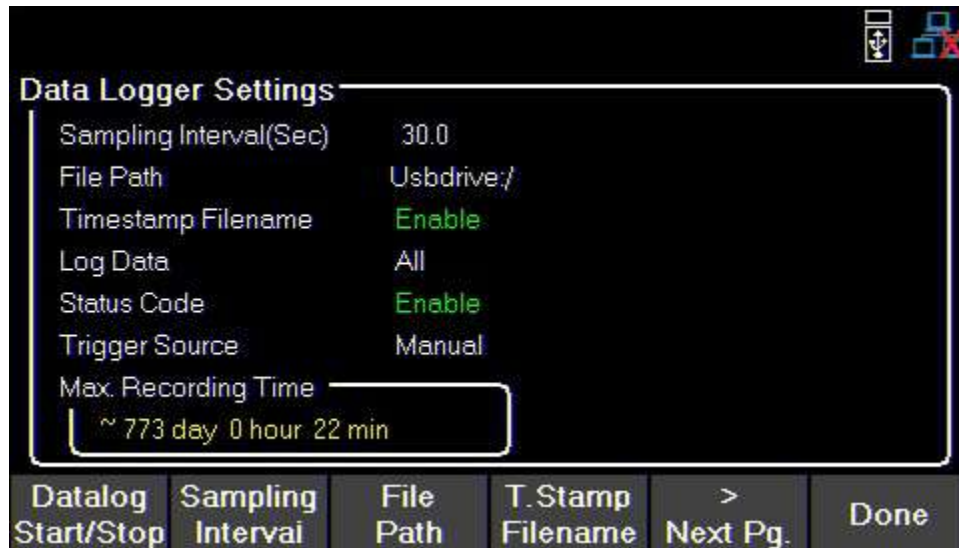

Figure 7.1 Data Logger Max Time

7.1 Using the Data Logger Function

Press the **Utility** button then use the soft key to select **Data logger**. The **Data Logger** settings can be selected in this menu.

Before starting the **Data Logger** its settings must be adjusted.

1. Set the desired **Sampling Interval** See [7.2.1](#)
2. Select a **File Path** to determine where to store the collected data. see [7.2.2](#)
3. Enable or disable **T. Stamp Filename**. See [7.2.3](#)
4. Choose what data to record. See [7.2.4](#)
5. Enable or disable **Status Code**. See [7.2.5](#)
6. Select a **Trigger Source**. See [7.2.6](#)
7. After setting all desired parameters press **datalog Start/Stop** to begin recording. Staring data log will vary based on chosen trigger. See [7.2.7](#)

7.2 Parameters

7.2.1 Sampling Interval

Press the **Utility** button then use the soft key to select **Data logger > Sampling Interval**.

Use the numeric keypad or rotary motor to select the sampling interval. Press **Enter** to assign the selected value. (.2s to 300s)

7.2.2 File Path

Press the **Enter** button then use the soft key to select **Data logger > File Path**.

Using the rotary knob and **Enter** navigate through the file path of the USB. Once the desired location has been found select **save** by pressing the softkey furthest to the left.

Verify that the correct path was chosen in the **Data Logger** menu.

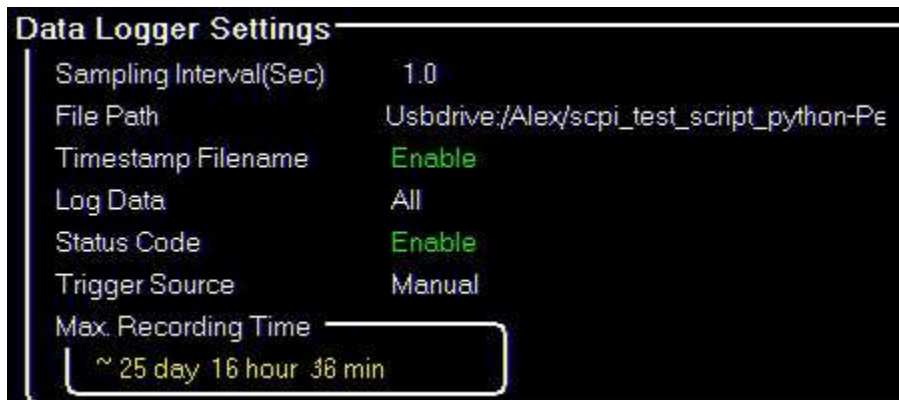

Figure 7.2 File Path Selected

7.2.3 T. Stamp Filename

Press the **Enter** button then use the soft key to select **Data logger > T. Stamp Filename**
Toggle to enable/disable time and date on the file name.

Example

Enabled 9240_log_20201017002307

Disabled 9240_log

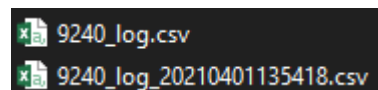

Figure 7.3 Enabled and Disabled T. Stamp

7.2.4 Log Data

Press the **Enter** button then use the soft key to select **Data logger > Next Pg. > Log Data**.

Select data to be logged.

- **All**: Record both voltage and current.
- **Voltage**: Record the voltage.
- **Current**: Record the current.

9241 XXXXXXXX Datalog		
Sample interval: 0.2		
Log data:All		
Date: 2021-04-01 13:54:18		
00:00:00.00	0	0 0x0000
00:00:00.20	0	0 0x0000
00:00:00.40	0	0 0x0000
00:00:00.60	0	0 0x0000
00:00:00.80	0	0 0x0000
00:00:01.00	0	0 0x0000
00:00:01.20	0	0 0x0000
00:00:01.40	0	0 0x0000
00:00:01.60	0	0 0x0000
00:00:01.80	0	0 0x0000
00:00:02.00	0	0 0x0000
00:00:02.20	0	0 0x0000
00:00:02.40	0	0 0x0000
00:00:02.60	0	0 0x0000
00:00:02.80	0	0 0x0000
00:00:03.00	0	0 0x0000
00:00:03.20	0	0 0x0000
00:00:03.40	0	0 0x0000
00:00:03.60	0	0 0x0000

Figure 7.4 Log Data All

The data is recorded in the following order:

Elapsed Time	Voltage	Current	Status Code
--------------	---------	---------	-------------

Table 7.1 Data Order

Data order will vary depending on **Log Data** selected.

NOTICE

7.2.5 Status Code

Press the **Enter** button then use the soft key to select Data logger > Status Code. Toggle to enable/disable status code.

Enabled **Status Code** will record all codes reported. See 7.4 for an example. In figure 7.4 the code 0x0001 is returned. This indicates OVP has been triggered.

Table 7.2 defines each code.

Code	Description
0x0001	Over Voltage Protection Triggered
0x0002	Over Current Protection Triggered
0x0004	Over Temperature Protection Triggered
0x0008	Sense not connected

Table 7.2 Status Code

7.2.6 Trigger Source

Press the **Enter** button then use the soft key to select **Data logger > Trigger Source**.

Datalog can be triggered in three ways: **Manual**, **Digital IO**, and **Remote**.

- **Manual:** Select to use manual trigger. The trigger softkey will be available as Datalog Start/Stop. See section 7.2.7
- **Digital IO:** Select to use the digital I/O pins to receive a trigger. To assign a function to a pin see section 8.4.1.
- **Remote:** Select to receive a trigger from a remote interface.

NOTICE

For **Digital IO** and **Remote** the first trigger will turn Data log on. A second trigger will begin data recording.  will be displayed on the top right when data is being logged. See [section 7.2.7](#)

7.2.7 Datalog Start/Stop

Press the  button then use the soft key to select **Data logger > Datalog Start/Stop**. Toggle to turn datalog On/Off.



will be displayed on the top right when data logger is on but not recording. The command INIT:IMM:DLOG will turn on data logger. For **Digital IO** press **Datalog Start/Stop** to turn data logger on.



will be displayed on the top right when data logger is recording. The command TRIG:DLOG:IMM will begin the recording. For **Digital IO** an input high signal to the set pin will turn data logger on.

If **Trigger Source** is set to manual pressing **Datalog Start/Stop** will start/stop recording without a second signal.

Utilities Menu

Configure the settings in the following menus:

- **User Settings**
- **Remote Interface**
- **I/O Configuration**
- **Test/Admin**
- **Error Log**
- **Help**

8.1 User Settings

Press the  button then use the soft key to select **Utilities > User Settings**.
The system's settings can be configured here.

8.1.1 Key Lock Output

Press the  button then use the soft key to select **Utilities > User Settings > Key Lock Output**.
Toggle to enable/disable the key lock.

- Enabling Key Lock Output changes the function of Key Lock.
- For more information see chapter **9**
- Default: OFF

8.1.2 Beep Sound

Press the  button then use the soft key to select **Utilities > User Settings > Beep Sound**.

Toggle to enable/disable the beeper sound.

Default: ON

8.1.3 Date

Press the  button then use the soft key to select **Utilities > User Settings > Date**.
Use the number pad to set the date.

YY/MM/DD

8.1.4 Time

Press the  button then use the soft key to select **Utilities > User Settings > Time**.

Use the number pad to set the time.

HH:MM:SS

8.1.5 Screen Intensity

Press the  button then use the soft key to select **Utilities > User Settings > Next Pg. > Screen Intensity**.

Use the rotary knob or number pad to set the screen brightness.

Lowest 1

Highest 10

8.1.6 Language

Press the  button then use the soft key to select **Utilities > User Settings > Next Pg. > Language**. Set the language for the **On Screen Help** guide. It **does not** change the language for the menus. For more information about On Screen Help see section [8.8](#)

8.2 Remote Interface

The 9240 series supports remote communication on up to three interfaces: USB, LAN, and GPIB (optional). While in remote mode the screen displays “RMT” in the upper right corner. Switching to remote mode does not impact the supply’s output parameters.

In remote mode, front panel operation is disabled. Only the Local button is enabled. Revert to manual mode by pressing the  key or by sending the command SYST:LOC.

Select and configure the following interfaces:

USB

LAN

GPIB

8.2.1 USB Settings

Press the **Utility** button then use the soft key to select **Utilities > I/O Config > USB Settings**.

The USB device port is located in the rear-panel. See **1.8**

The 9240 series are both USBTMC and USB VCP compliant.

In the **USB Settings** menu use the soft keys to select either:

- USBVCP
- USBTMC

Default: USBVCP



Figure 8.1 USB Details

The VISA Resource string gives USB0::<Vendor ID>::<Product ID>::<Serial Number>:INSTR

Example From figure **8.1** :

<Vendor ID> = 0x3121

<Product ID> = 0x0003 for 9240, 0x0004 for 9241, or 0x0005 for 9242

<Serial Number> = XXXXXXXXX

When using USBVCP set the port setting to:

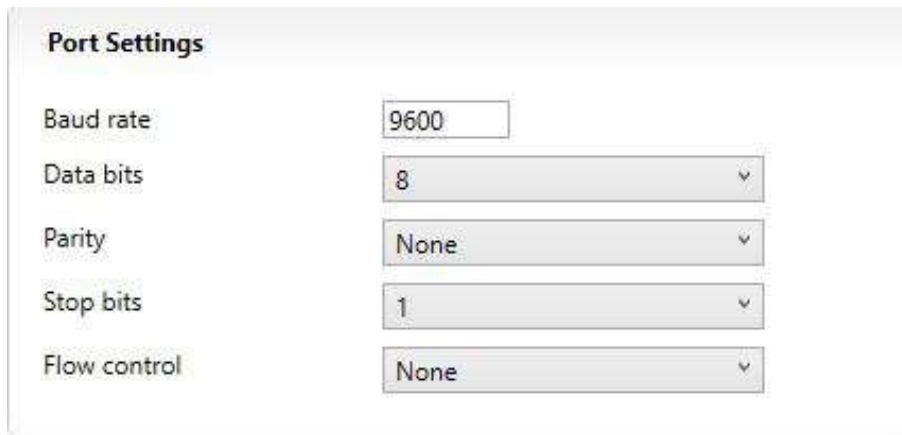

Figure 8.2 USB Port Settings

8.2.2 LAN

To configure the **LAN Settings**

Press the **Utility** button then use the soft key to select **Utilities > I/O Config > LAN Settings**.

The following settings are available in **LAN Settings**:

- **IP Mode**
- **IP Address**
- **Subnet Mask**
- **Gateway IP**
- **Primary DNS**
- **Hostname**
- **LAN Reset**
- **Restore Default**
- **LAN Status**

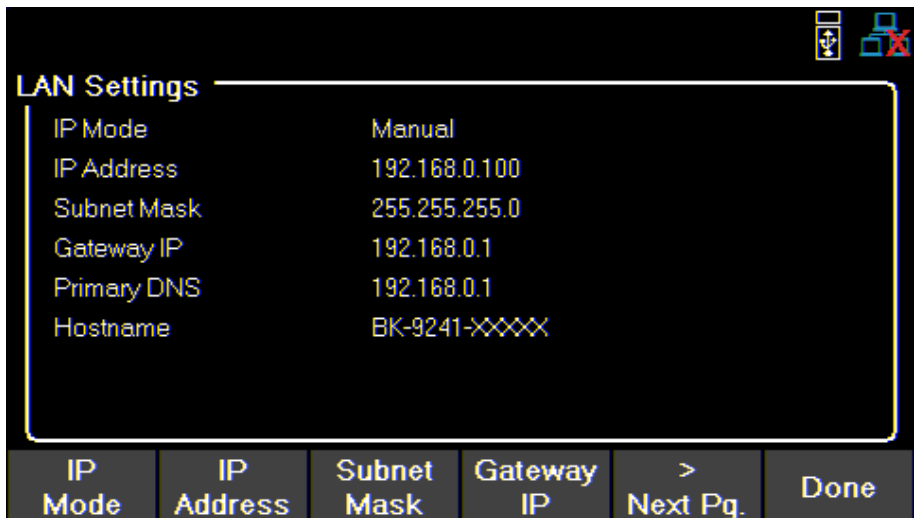

Figure 8.3 LAN Settings

IP Mode

Select **Dynamic Host Configuration Protocol (DHCP)** or **Manual** to set how the LAN settings will be configured.

Press the  button then use the soft key to select **Utilities > I/O Config > LAN Settings > IP MODE**.



The easiest way to configure the LAN settings is to set the IP Mode to **DHCP**. **DHCP** will automatically assign an IP address to the instrument.

The settings can manually be configured by selecting **Manual**.

IP Address

The **IP Address** is a unique string of numbers separated by periods. To enter an IP address:

Press the  button then use the soft key to select **Utilities > I/O Config > LAN Settings > IP Address**.



Use the numeric keypad to enter an IP address. Then   keys are used to separate each number in the string. After inputting each number press  to set the address.

Subnet Mask

Subnet Mask divides the IP address into network address and host address.

To set **Subnet Mask**:

Press the  button then use the soft key to select **Utilities > I/O Config > LAN Settings > Subnet Mask**.

Use the numeric keypad to enter the subnet mask. Then   keys are used to separate each number in the string. After inputting each number press  to set the address.



Gateway IP

The gateway address is by default the IP address of the network device that connects the instrument.

If **IP Mode** is set to **DHCP** **Gateway IP** does not have to be set.

To set **Gateway IP** :

Press the  button then use the soft key to select **Utilities > I/O Config > LAN Settings > Gateway IP**.

Use the numeric keypad to enter an IP address. Then   keys are used to separate each number in the string. After inputting each number press  to set the address.



Primary DNS

Domain Name Service (DNS) is the system that automatically translates Internet addresses to the numeric machine addresses. The DNS address is the IP address of the system that performs this service.

If **IP Mode** is set to DHCP DNS will automatically be set.

To set the **Primary DNS** :

Press the  button then use the soft key to select **Utilities > I/O Config > LAN Settings > Primary DNS** .

Use the numeric keypad to enter an IP address. Then   keys are used to separate each number in the string. After inputting each number press  to set the address.

Hostname

Each instrument comes with a unique hostname that can be changed. The default hostname has the following format:

BK-<modelnumber>-<Serialnumber>

Figure 8.3 shows the example:

BK-9241-XXXXX

LAN Reset

LAN Reset resets all LAN settings and webpage passwords.

To reset LAN :

Press the  button then use the soft key to select **Utilities > I/O Config > LAN Settings > LAN Reset** .

Before resetting a warning will display informing both LAN settings and webpages passwords will be reset.

Select **Yes** to finalize the reset.

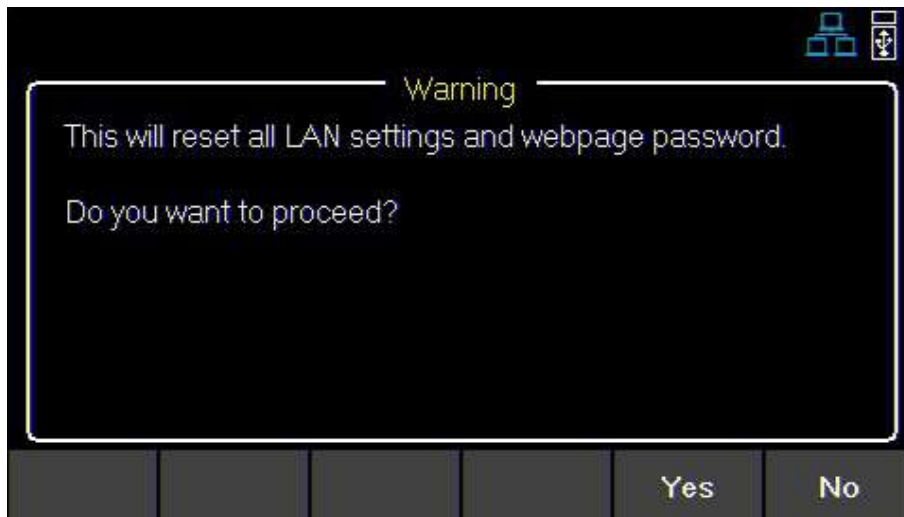

Figure 8.4 Reset

Restore Default

Restore Default will set all LAN settings to their factory defaults.

To restore factory defaults:

Press the **Utility** button then use the soft key to select **Utilities > I/O Config > LAN Settings > Restore Default** .

Before restoring LAN settings to default the following warning will display.

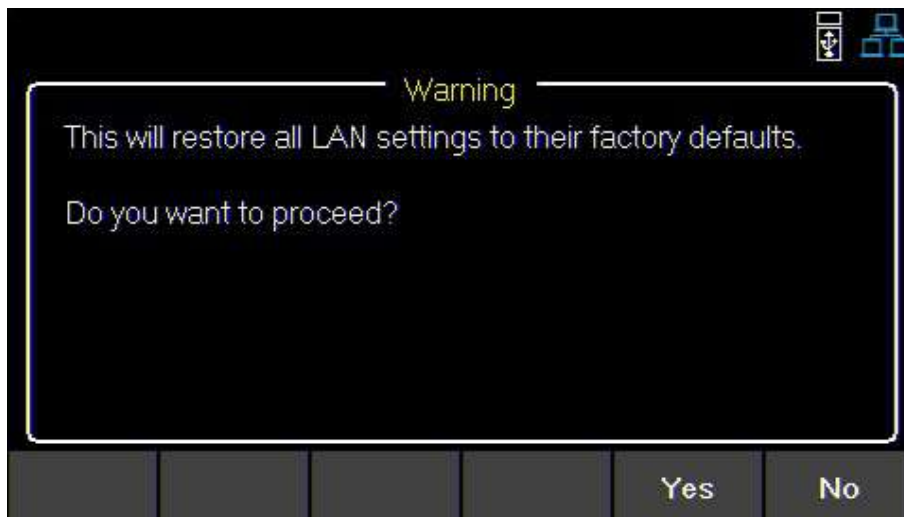

Figure 8.5 Restore Factory Defaults

Select **Yes** to set to factory default.

LAN Status

LAN Status provides an overview of the LAN settings.

To view the LAN status:

Press the **Utility** button then use the soft key to select **Utilities > I/O Config > LAN Status**.

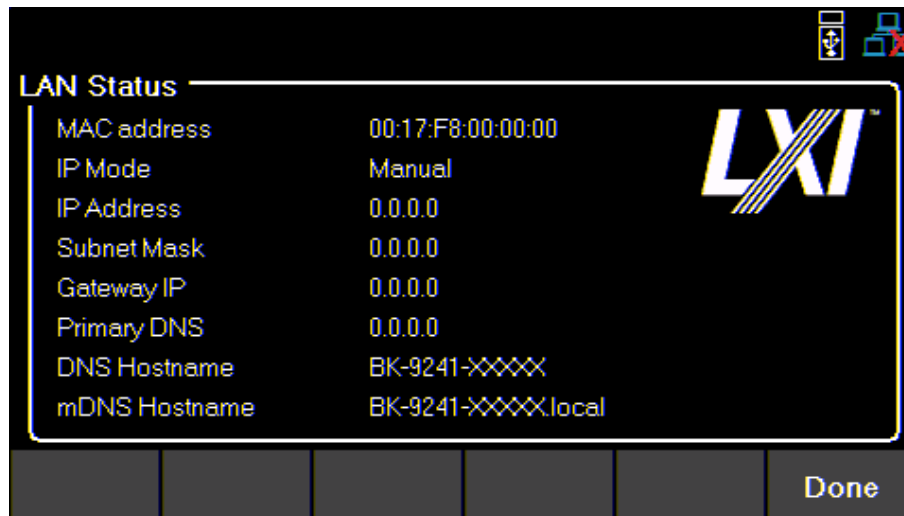

Figure 8.6 LAN Status

8.3 GPIB (optional)

In **GPIB** the GPIB address can be changed from 01 to 30.

To change the GPIB address:

Press the **Utility** button then use the soft key to select **Utilities > I/O Config > GPIB**.

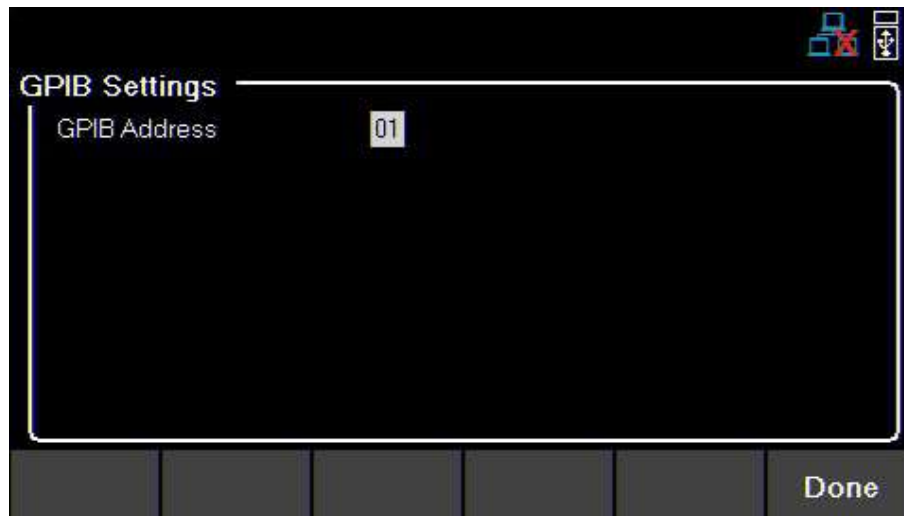

Figure 8.7 GPIB Address

Use the numeric keypad to enter the new address, then press the **Enter** key.

The rotary knob can also be used to set the address. **Enter** must be pressed to set the new address.

8.4 Digital I/O

To enter the **Digital I/O** menu:

Press the **Utility** button then use the soft key to select **Utilities > I/O Config > Digital I/O**.

Select the function and polarity of pins: 1, 2, and 3.

- **Pin Functions**
 - **None**
 - **Digital In | Out**
 - **Trigger In | Out**
 - **Fault Out/Inhibit In**
 - **Polarity Pos | Neg**
- **Inhibit Mode**
 - **Off**
 - **Latched**
 - **Live**

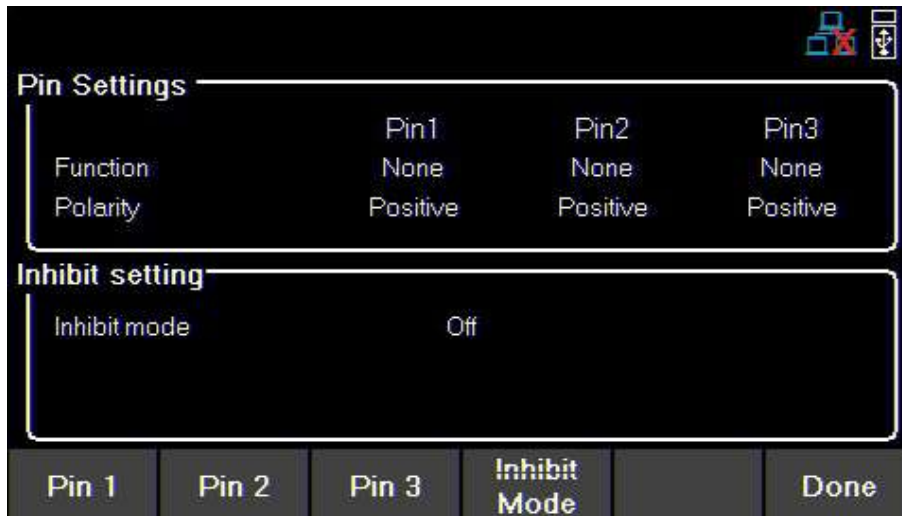



Figure 8.8 Digital I/O Menu

8.4.1 Functions

Default: None

To configure a pin:

Press the  button then use the soft key to select **Utilities > I/O Config > Digital I/O > Pin(#)**.

None

Set selected pin to have no function.

Digital In | Out

Toggle to select In/Out digital function.

Digital In: Receive a signal from external device.

Digital Out: Send a signal to external device.



WARNING

The input voltage range for digital I/O pins is 0 V to 5 V. To prevent damage to the instrument, do not exceed 5 V or supply a negative voltage to the digital I/O pins.

Trigger In | Out

Toggle to select In/Out trigger function.

Trigger In: Receives signal that triggers set event.

Trigger Out: Sent trigger signal when specified. (BOST or EOST)

In **List Mode**, the **Trigger In** function can be used to trigger the next step when **Trigger Source** is set to **Digital IO**.

In **Datalog**, the **Trigger In** function can be used to start/stop data logging when **Trigger Source** is set to **Digital IO**.

Trigger Out is only available for list mode, step BOST and EOST.

Fault Out

Enable a fault condition, which generates a protection fault signal on the digital port.

Different conditions such as over voltage, over current, or over temperature will generate a fault event.

The fault event will “disable” all outputs without turning them off.

The outputs are “disabled” by setting the outputs as low as possible.

8.4.1 Polarity

Default: Positive

Set polarity of selected pin.

Positive

A logic true signal is received as a voltage high.

Negative

A logic true signal is received as a voltage low.

8.4.1 Inhibit Mode

Receive an external input signal that controls the output state.

Default: Off

To set **Inhibit Mode**:

1. Assign the **inhibit In** function to pin 3 by:

Press the  button then use the soft key to select **Utilities > I/O Config > Digital I/O > Pin 3 > Inhibit In**.

2. Select Inhibit Mode: Press the  button then use the soft key to select **Utilities > I/O Config > Digital I/O > Inhibit Mode**.
3. Select one of the following modes:

The following modes are only available for pin 3.

NOTICE

Off

The inhibit input is ignored.

Latched

A logic-true transition signal will disable the power supply. The output will remain disabled.

Live

Power supply output follows the state of the inhibit signal. If the inhibit signal is true the output is disabled. When it is false the output is enabled.

8.5 Test/Admin

8.5.1 Self Test

Run a Module test.

Press the **Utility** button then use the soft key to select **Utilities > Test/Admin > Self-Test > Start**.

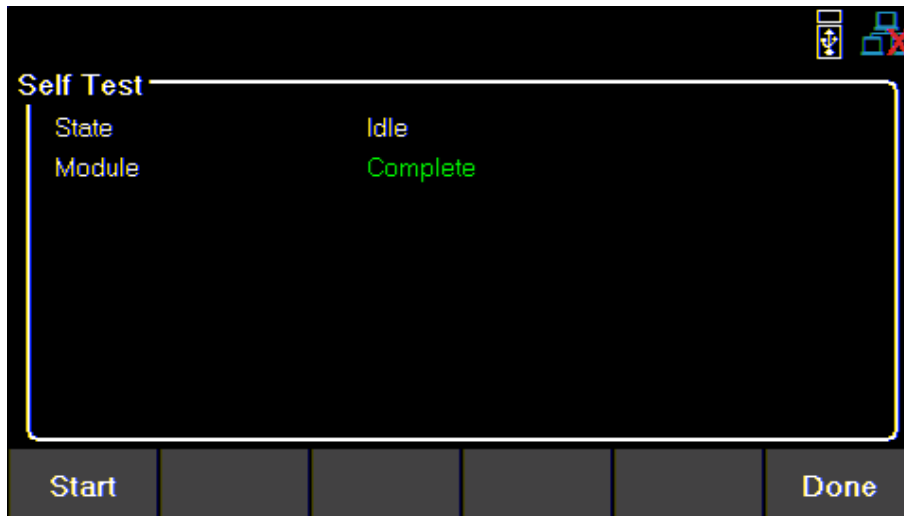

Figure 8.9 Self Test Complete

8.5.2 Security

The **Security Settings** are locked and can be accessed by entering the default code **77416699**.

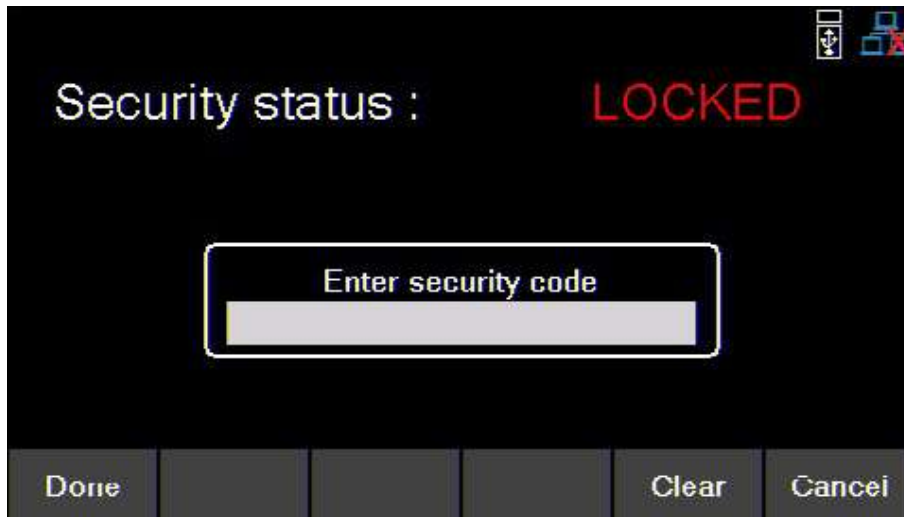
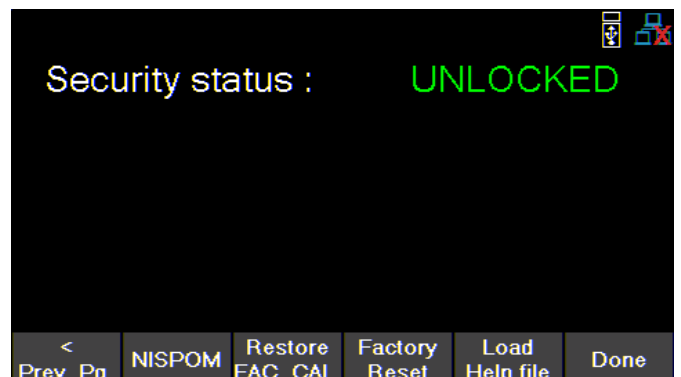
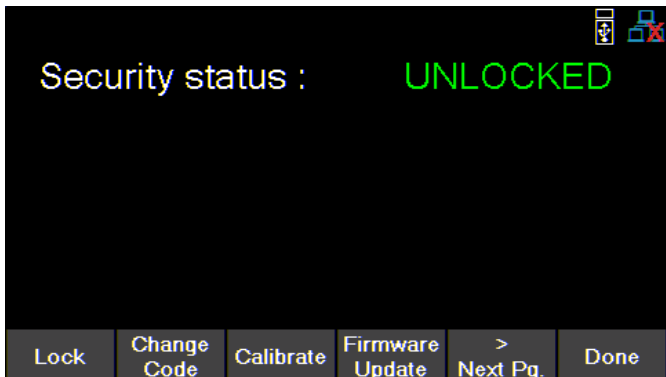

Figure 8.10 Security Locked

NOTICE

The default password can be change in the **Change Code** menu. If the set code is forgotten contact B&K Precision customer support.

Use the password (**77416699**) to gain access to the following settings.



- **Lock**
- **Change Code**
- **Calibrate**
- **Firmware Update**
- **NISPOM**
- **Restore FAC. CAL.**
- **Factory Reset**
- **Load Help file**

8.5.3 Lock

Sets security status to Lock. Press the  button then use the soft key to select **Utilities > Test/Admin > Security > Lock** .

If **Done** is selected without locking the security settings, the user will be prompted that the security settings will not be locked.

8.5.4 Change Code

Changes the security code.

Press the  button then use the soft key to select **Utilities > Test/Admin > Security > Change Code**.

8.5.5 Calibrate

Enter calibration mode.

Press the  button then use the soft key to select **Utilities > Test/Admin > Security > Calibrate** . See chapter **Calibration Adjustment Procedure** to adjust the units calibration.

8.5.6 Firmware Update

Update the firmware and module. Press the  button then use the soft key to select **Utilities > Test/Admin > Security > Firmware Update** .

8.5.7 NISPOM

Select for complete memory wipe. Settings and list memory, help files and hex files will be deleted. Press the  button then use the soft key to select **Utilities > Test/Admin > Security > Next Pg. >NISPOM** .

8.5.8 Restore FAC. CAL.

Select to restore the factory calibration table. Press the  button then use the soft key to select **Utilities > Test/Admin > Security > Next Pg. > Restore FAC. CAL.**

8.5.9 Factory Reset

Saved settings and list memory are deleted. Help files and hex files will be preserved. Press the  button then use the soft key to select **Utilities > Test/Admin > Security > Next Pg. > Factory Reset** .

8.5.10 Load Help file

Loads language help files from USB flash drive connected to USB host port. Press the  button then use the soft key to select **Utilities > Test/Admin > Security > Next Pg. > Load Help file** .

8.6 Error Log

View up to 50 previously set error codes.

Press the **Utility** button then use the soft key to select **Utilities > Error Log**.

No.	Time	CH	Error code
01	2020/12/15 06:04:24	1	0x0001
02	2020/12/15 06:05:25	1	0x0002
03	2020/12/15 06:13:56	1	0x0008
04	2020/12/16 04:18:30	1	0x0002
05	2020/12/16 05:31:03	3	0x0008
06	2020/12/16 06:18:05	2	0x0008

Clear All Save to USB Done

Figure 8.11 Error Log

Errors are placed in the order that they were encountered. 1 being the most recent.

The error log displays up to 50 error codes.

After reaching 50 error codes no more codes will be reported in the error log.

To continue filing error codes the error log list must be cleared

The error log can be saved into a USB flash drive connected to the USB port on the front panel.

Save the log by:

Pressing the **Utility** button then use the soft key to select **Utilities > Error Log > Save** .

Use the rotary knob and the **Enter** button to navigate through the file path of the USB. Once the desired location has been found select **Save** by pressing the softkey furthest to the left.

Clear the data log by:

Pressing the **Utility** button then use the soft key to select **Utilities > Error Log > Clear All > Yes**.

Code	Description
0x0001	Over Voltage Protection Triggered
0x0002	Over Current Protection Triggered
0x0004	Over Temperature Protection Triggered
0x0008	Sense not connected

Table 8.1 Status Code

8.7 Help

To enter the Help menu:

Press the **Utility** button then use the soft key to select **Utilities > Help**.

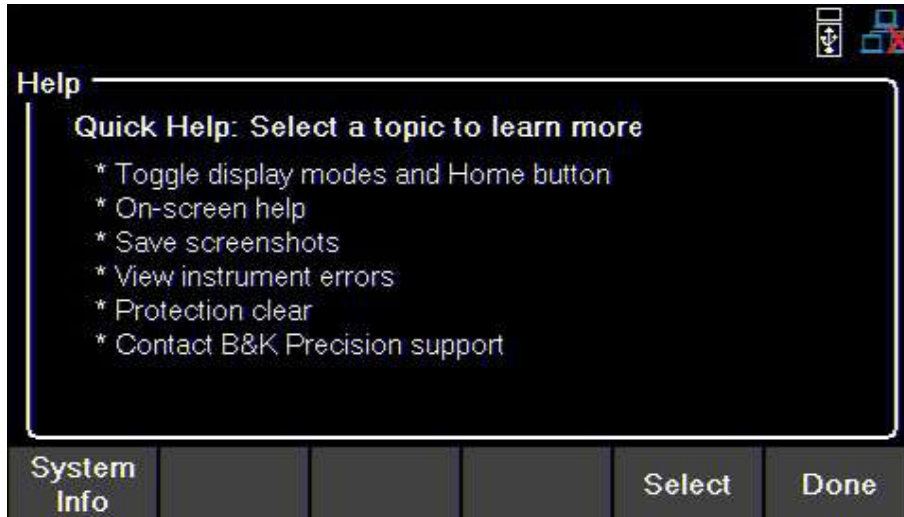

Figure 8.12 Help Menu

Use the rotary knob to navigate the help options shown in figure 8.12.

To select the Quick help topic press the **Enter** key or press the **Select** softkey.

System Info

To view the instrument’s general information:

Press the **Utility** button then use the soft key to select **Utilities > Help > System Info**.

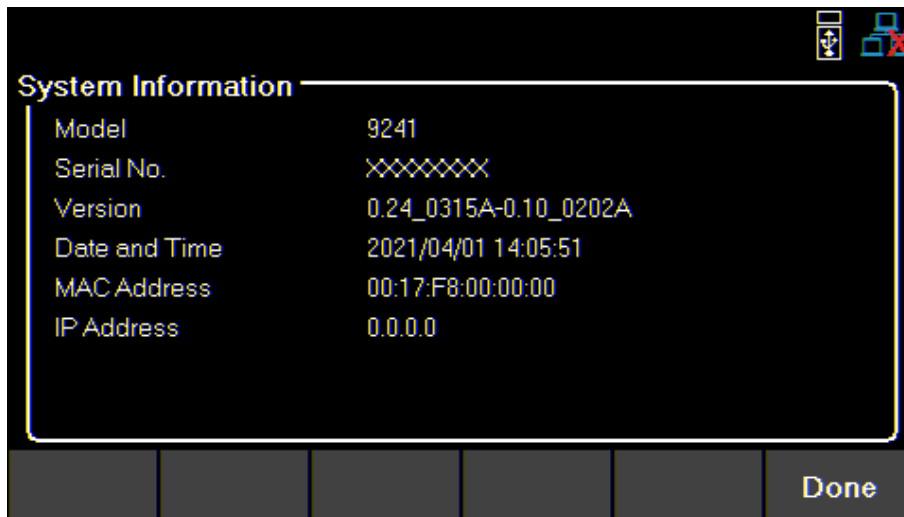

Figure 8.13 System Info

8.8 On Screen Help

Press and hold any soft key that selects a menu branch for 3 seconds to receive an explanation of what can be found in that branch.

Key Lock

Lock all front panel keys including **ON**.

Press the **Utility** button then use press and hold the soft keys **Key Lock** for 3 seconds.

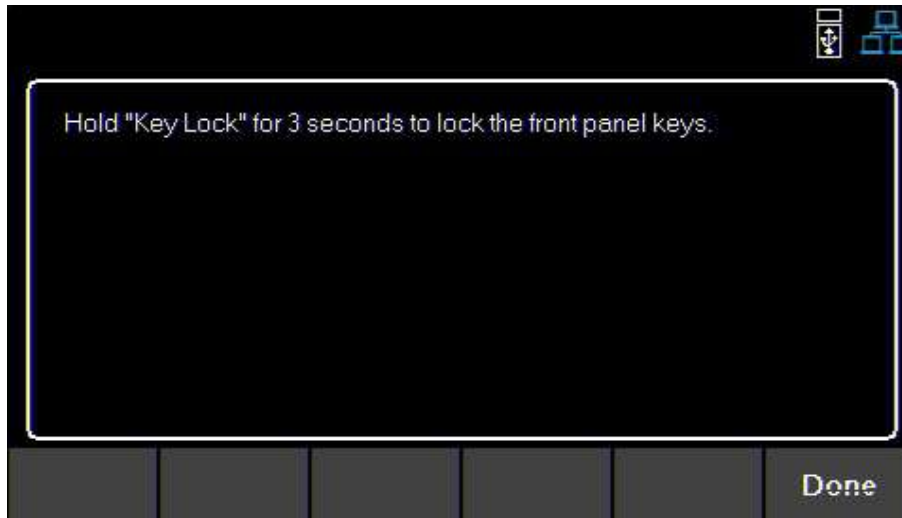

Figure 9.1 Key Lock

If **Key Lock Output** is enabled, holding Key Lock for 3 seconds locks all front panel keys except **ON** and **All CH On/Off**. See section [8.1.1](#) to enable/disable Key Lock Output.

To unlock the front panel use the softkey to select **Unlock**.

Save/Recall

Save/Recall the instruments Output Settings and Power-On Settings.

10.1 Save the Output Settings

10.1.1 Save to Internal Memory

Save the instrument's output settings to the internal memory. A total of 10 (0 to 9) output settings can be saved.

To save the output settings :

Press the  button then use the soft keys to select **Save > Save to INT.**

Using the numeric keypad enter a number from 0 to 9 to save the output settings to that address. The settings will be saved after a short delay.

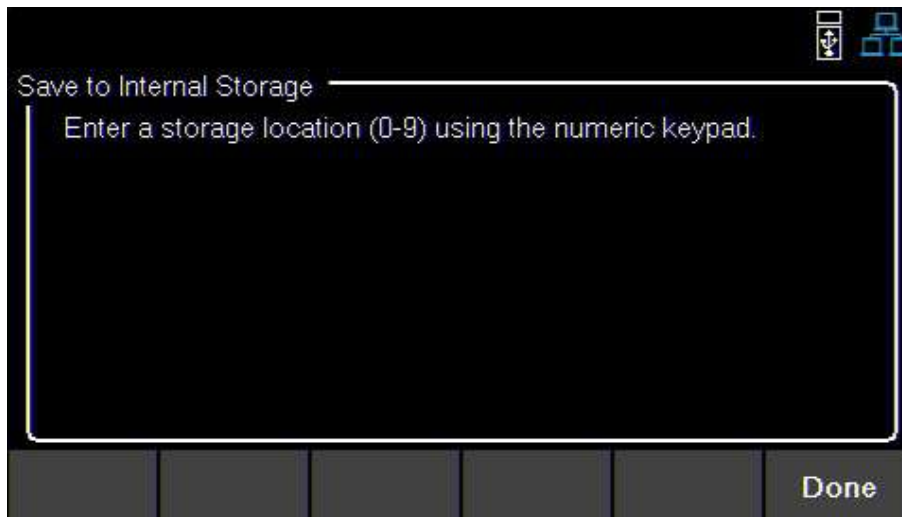



Figure 10.1 Save to Internal Storage

10.1.2 Save to USB

Save the instrument's output settings to a USB flash drive connected to the front panel USB host port.

Press the  button then use the soft keys to select **Save > Save to USB.**

Using the rotary knob navigate through the file paths of the USB. Use the **Enter** button to expand folders. Once the desired location has been found press **Save**. The output settings will be saved after a short delay.

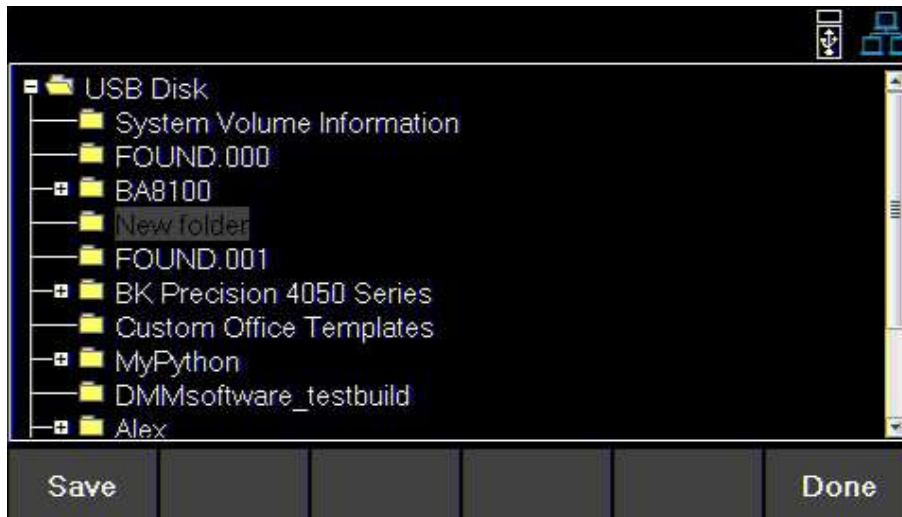

Figure 10.2 Save to USB

10.2 Recall the Instrument's Settings

Recall previously saved output settings from the internal memory. A total of 10 (0 to 9) user settings can be saved.

To recall settings :

Press the **SAVE Recall** button then use the soft keys to select **Recall > Recall from INT**.

Use the numeric keypad to enter a number from 0 to 9 to recall the output settings stored in that address. The settings will be recalled after a short delay.

10.2.1 Recall from USB

Recall the instrument's output settings from a USB drive.

Press the **SAVE Recall** button then use the soft keys to select **Recall > Recall from USB**.

Use the rotary knob to navigate through the file paths of the USB. Use the **Enter** button to expand folders. Once the desired location has been found press **Load**. The settings will be recalled after a short delay.

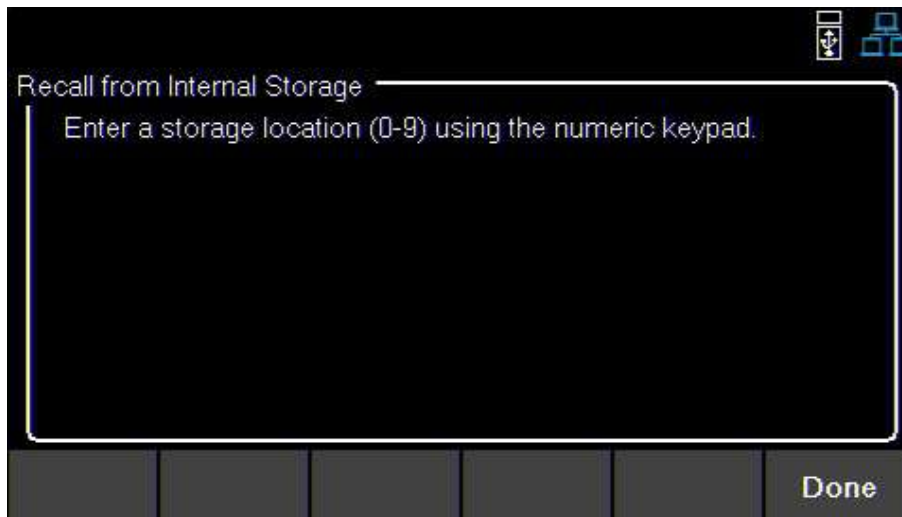

Figure 10.3 Recall from Internal Memory

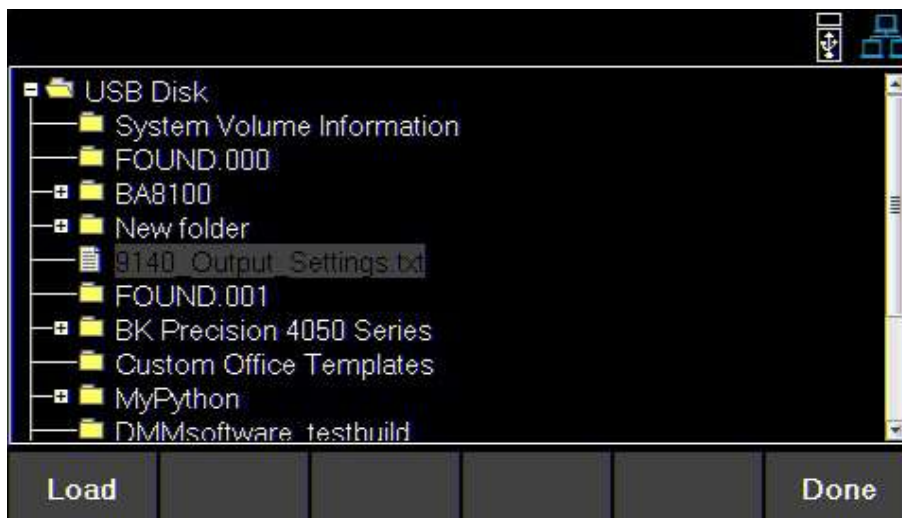

Figure 10.4 Recall from USB

10.3 Screenshot

To take a screenshot:

Press **SAVE Recall** + **Enter** together for 3+seconds until you hear a beep.

A USB must be plugged in for this function.

10.4 Power-On Settings

Load previously saved output parameters on power-on.

Off

To turn off **Power-On Mode**:

Press the  button then use the soft keys to select **Power-On Settings > Power- On Mode > Off**.



Last

To set the output parameters to the previous parameters before powering-off the instrument: Press the

 button then use the soft keys to select **Power-On Settings > Power- On Mode > Last**.

User

To set the output parameters previously saved parameters:

- Press the  button then use the soft keys to select **Power-On Settings > Power- On Mode > User**.
- Press the  button then use the soft keys to select **Power-On Settings > User Settings**.
- Use the numeric keypad or the rotary knob to assign an address (0 to 9).

To save settings see [10.1](#).

Default Values and Ranges

Set the instrument's output settings to default.

Press the  button then use the soft keys to select **Set to Default**.

9240			
Parameter	Default	Max	Min
VSET	0.000	32.320	0.000
ISET	1.00	8.08	0.015
Vmax	32.320	32.320	1.000
Vmin	0.000	32.320	0
Vslew	1600	3200	0.001
Islew	500	800	1
OVP Limit	35.200	35.200	0.000
OCP Limit	8.800	8.800	0.015
Timer	99:59:59	99:59:59	00:00:00
On Delay	0.000	3600	0.000
Off Delay	0.000	3600	0.000
Datalogger Sampling Interval	0.2	300	0.2
List Dwell	0.1	9999	0.1
List Voltage	1.000	32.32	0.000
List Current	0.015	8.08	0.015
List Repeat	000000	100000	000000

Table 10.1 9240 Default Values & Ranges

9241			
Parameter	Default	Max	Min
VSET	0.000	60.600	0.000
ISET	1.00	4.000	0.015
Vmax	60.600	60.600	1.000
Vmin	0.000	60.600	0
Vslew	1600	3200	0.001
Islew	500	800	1
OVP Limit	66.000	66.000	0.000
OCP Limit	4.400	4.400	0.015
Timer	99:59:59	99:59:59	00:00:00
On Delay	0.000	3600	0.000
Off Delay	0.000	3600	0.000
Datalogger Sampling Interval	0.2	300	0.2
List Dwell	0.1	9999	0.1
List Voltage	1.000	32.32	0.000
List Current	0.015	8.08	0.015
List Repeat	000000	100000	000000

Table 10.2 9241 Default Values & Ranges

9242			
Parameter	Default	Max	Min
VSET	0.000	60.600	0.000
ISET	1.00	10.100	0.015
Vmax	60.600	60.600	1.000
Vmin	0.000	60.600	0
Vslew	1600	3200	0.001
Islew	500	800	1
OVP Limit	66.000	66.000	0.000
OCP Limit	11.000	11.000	0.015
Timer	99:59:59	99:59:59	00:00:00
On Delay	0.000	3600	0.000
Off Delay	0.000	3600	0.000
Datalogger Sampling Interval	0.2	300	0.2
List Dwell	0.1	9999	0.1
List Voltage	1.000	32.32	0.000
List Current	0.015	8.08	0.015
List Repeat	000000	100000	000000

Table 10.3 9242 Default Values & Ranges

Calibration Adjustment Procedure

Calibration Interval

The recommended calibration interval for the 9240 series is one year.

To enter the **Calibration Menu**:

Press the **Utility** button, then use the soft key to select **Utilities > Test/Admin > Security > Calibrate**.

In the **Calibration Menu** use the softkeys to select a parameter from the menu to calibrate.

- **Voltage**
- **Current**
- **OVP**
- **OCP**
- **RTC**

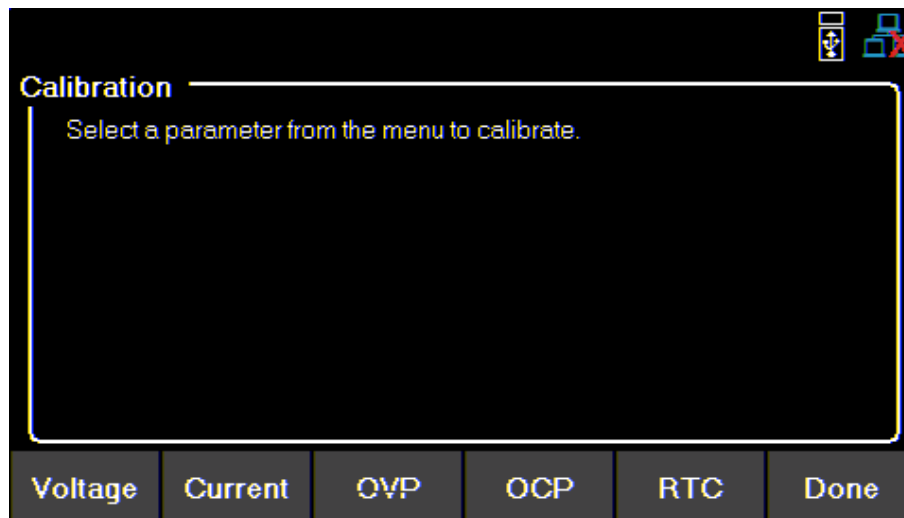

Figure 11.1 Calibration Parameters

11.1 Voltage Calibration Adjustment

For the voltage calibration procedure a precise DMM will be needed.

To adjust the voltage calibration:

1. Enter the **Calibration Menu**

- Press the  button, then use the soft key to select **Utilities > Test/Admin > Security**.

Use the numeric keypad to enter security code. See the subsection **Security**. Press the  button to enter the security menu.

2. Use the softkeys to select **Voltage**.

3. Connect the DMM's voltage input to the power supply's binding post.

4. Use the softkey to select **Start**.

5. Use the numeric keypad to enter the measured voltage. Press the  button to configure the point.

6. Repeat step 6 for the remaining calibration points.

7. Upon entering the last calibration point value the display will return to the select parameter calibration menu.

11.2 Current Calibration Adjustment

For the current calibration procedure a precise DMM will be needed.

To adjust the current calibration:

1. Enter the **Calibration Menu**

- Press the  button, then use the soft key to select **Utilities > Test/Admin > Security**.

Use the numeric keypad to enter security code. See the subsection Security. Press the  button to enter the security menu.

2. Use the softkeys to select **Current** .

3. Verify the correct channel is chosen.

4. Connect the DMM current input to the power supply's binding post.

Note:

Upon entering a calibration point the unit will immediately output the next current point. To avoid blowing the DMM's fuse ensure the correct DMM's input is chosen.

The points' output are as follows:

9240

1st Point 0.4 A
2nd Point 2.8 A
3rd Point 5.5 A
4th Point 8.0 A

9241

1st Point 0.2 A
2nd Point 1.4 A
3rd Point 2.7 A
4th Point 4.0 A

5. Use the softkey to select **Start**.

6. Use the numeric keypad to enter the measured current. Press the  button to configure the point.

7. Repeat step 6 for the remaining calibration points.

8. Upon entering the last calibration point value the display will return to the select parameter calibration menu.

11.3 OVP Calibration Adjustment

For the over voltage protection calibration the instrument's voltage must be calibrated.

To adjust the OVP calibration:

1. Enter the **Calibration Menu**

- Press the  button, then use the soft key to select **Utilities > Test/Admin > Security**.

Use the numeric keypad to enter security code. See the subsection Security. Press the  button to enter the security menu.

2. Use the softkeys to select **OVP**.

3. Connect the DMM's voltage input to the power supply's binding.

4. Use the softkey to select **Start**.

5. **Calibration State** will show as **Busy**. After a few seconds the calibration will be adjusted on its own.

6. Upon calibration the display will return to the select parameter calibration menu.

11.4 OCP Calibration Adjustment

For the over current protection calibration the instrument's current must be calibrated.

To adjust the OCP calibration:

1. Enter the **Calibration Menu**

- Press the  button, then use the soft key to select **Utilities > Test/Admin > Security**.

Use the numeric keypad to enter security code. See the subsection Security. Press the  button to enter the security menu.

2. Use the softkeys to select **OCP**.

3. Verify the correct channel is chosen.

4. Connect the DMM's 10 A input to the power supply's binding post corresponding to the selected channel.

5. Use the softkey to select **Start**.

6. **Calibration State** will show as **Busy**. After a few seconds the calibration will be adjusted on its own.

7. Upon calibration the display will return to the select parameter calibration menu.

11.5 RTC Calibration Adjustment

To adjust the Real-Time Clock(RTC) calibration:

1. Enter the **Calibration Menu**

- Press the  button, then use the soft key to select **Utilities > Test/Admin > Security**.

Use the numeric keypad to enter security code. See the subsection Security. Press the  button to enter the security menu.

2. Use the softkeys to select **RTC**.

3. Use the softkey to select **Start**.

4. **Calibration State** will show as **Busy**. The calibration will be adjusted on its own in about 4 to 5 mins.

5. **Calibration State** will show as **Success** once the calibration has finished.

Performance Verification

Performance verification ensures the instrument will meet specifications listed in the datasheet. Load regulation can be tested for both the front and rear outputs.

Note:

All specifications apply to the unit after a temperature stabilization time of 15 minutes over an ambient temperature range of $23\text{ }^{\circ}\text{C} \pm 5\text{ }^{\circ}\text{C}$. Specifications are valid for single unit operation only.

CV Load Regulation Front Panel Output

1. Turn off the power supply before making any connections.
2. Connect the: DMM, electronic load, and the rear panel remote sense to the power supply's terminal being tested.
(Remote sense must correspond with the channel being tested.)

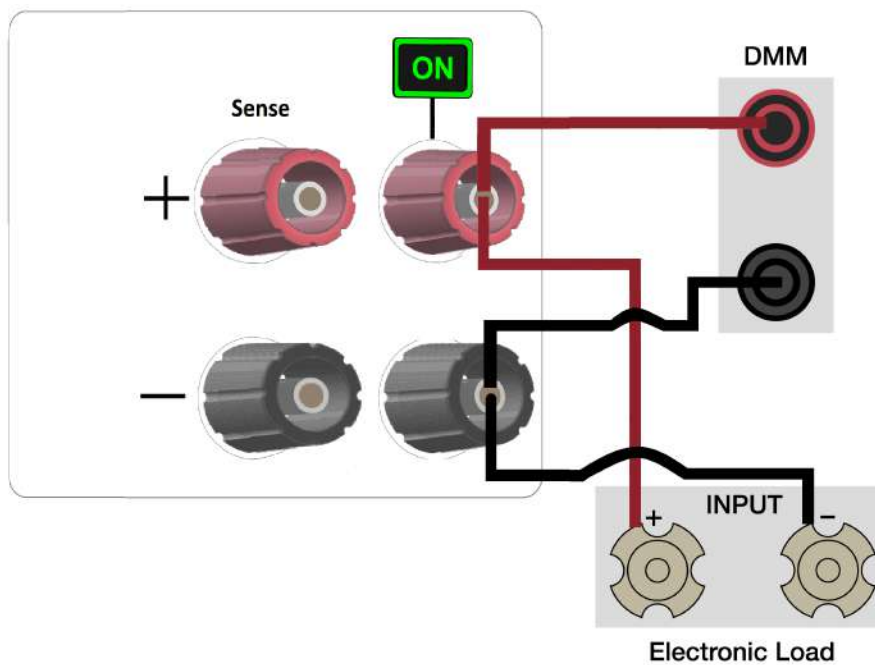

Figure 12.1 Front Panel Wiring Diagram

Note:

Keep all cables as short as possible.

3. Turn on the power supply.
4. Set the power supply settings of the channel being tested to the values given in table **12.1**.
5. Set the electronic load settings to the stated values in table **12.1**.
6. Enable remote sense. See section Remote Sense.
7. Enable the channel output.
8. Enable the electronic load. Monitor the power supply to ensure it remains in CV mode. If the power supply switches to CC slightly lower the current on the electronic load until the power supply return to CV mode.
9. Give the power supply some time to settle and record the DMM reading as V load.
10. Disable the electronic load and record the DMM reading as V no load.
11. Take the difference between V load and V no load (V load - V no load) and record the value as the voltage regulation. The difference should be within the **specification limit**.

CV Load Regulation Rear Panel Output

1. Turn off the power supply before making any connections.
2. Connect the: DMM, electronic load, and the rear panel remote sense to the power supply's rear +/- terminal being tested. Use jumpers to connect the +S to + and -S to -. See figure **12.2**
(Remote sense must correspond with the channel being tested.)
3. Turn on the power supply.
4. Set the power supply settings of the channel being tested to the values given in table **12.1**.
5. Set the electronic load settings to the stated values in table **12.1**.
6. Enable remote sense. See section Remote Sense.
7. Enable the channel output.

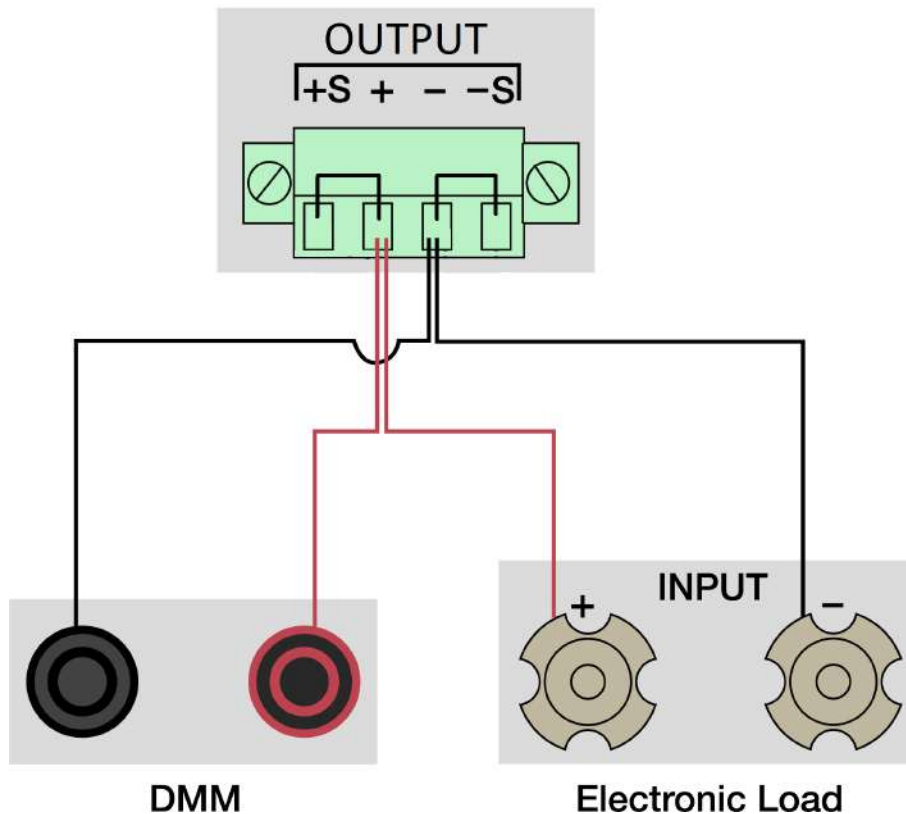

Figure 12.2 Rear Panel Wiring Diagram

8. Enable the electronic load. Monitor the power supply to ensure it remains in CV mode. If the power supply switches to CC slightly lower the current on the electronic load until the power supply return to CV mode.
9. Give the power supply some time to settle and record the DMM reading as V load.
10. Disable the electronic load and record the DMM reading as V no load.
11. Take the difference between V load and V no load (V load - V no load) and record the value as the voltage regulation. The difference should be within the **specification limit**.

Model	Power Supply Settings			Electronic Mode	Electronic Current	Load Regulation Limit	
	Voltage	Current	Remote			Lower Limit	Upper Limit
9240	32.000 V	3.750 A	Enabled	CC	3.740 A	- 6.2 mV	+ 6.2 mV
9241	60.000 V	2.000 A	Enabled	CC	1.990 A	- 9 mV	+ 9 mV
9242	60.000 V	3.333 A	Enabled	CC	3.320 A	- 9 mV	+ 9 mV

Table 12.1

Specifications

Model	9240	9241	9242	
Output Rating				
Voltage	32 V	60 V	60 V	
Current	8 A	4 A	10 A	
Maximum Output Power	120 W		200 W	
Load Regulation⁽¹⁾ ± (% output + offset)				
Voltage	≤ 0.01% + 3 mV			
Current	≤ 0.01% + 3 mA			
Line Regulation⁽¹⁾ ± (% output + offset)				
Voltage	≤ 0.01% + 2 mV			
Current	≤ 0.01% + 3 mA			
Ripple and Noise (20 Hz to 20 MHz)				
Normal Mode Voltage p-p	≤ 5 mV	≤ 10 mV		
Normal Mode Voltage rms	≤ 1 mV	≤ 2 mV		
Normal Mode Current rms	≤ 3 mA			
Programming / Readback Resolution				
Voltage	1 mV			
Current	1 mA			
Programming / Readback Accuracy ± (% output + offset)				
Voltage	0.03% + 4 mV	0.03% + 8 mV		
Current	0.1% + 5 mA	0.1% + 3 mA		
Temperature Coefficient per °C				
Voltage	6.4 mV / °C	12 mV / °C		
Current	1.6 mA / °C	0.8 mA / °C		
Output Response Time ⁽²⁾				
Rise Time	Full load	10 ms	20 ms	
	No load	10 ms	20 ms	
Fall Time	Full load	10 ms	20 ms	
	No load	250 ms	250 ms	
Transient Response ⁽³⁾				
Time	0.5 ms			
Protection				
OVP	Range	35.2 V	66 V	
	Accuracy	320 mV	600 mV	
OCP	Range	8.8 A	4.4 A	11 A
	Accuracy	80 mA	40 mA	100 mA

General		
Remote Sense Compensation	1 V	
Command Response Time ⁽⁴⁾	10 ms	
Power Factor	0.98 / 115 VAC 0.94 / 230 VAC	
I/O Interfaces	USB (USBTMC-compliant and virtual COM), LAN (1.5 LXI device specification 2016), GPIB (optional)	
AC Line Input	100 VAC to 240 VAC ± 10%, 47 Hz to 63 Hz	
Maximum Rated Input Power	200 VA	
Temperature Ratings	Operation	32 °F to 104 °F (0 °C to 40 °C)
	Storage	14 °F to 158 °F (-10 °C to 70 °C)
Dimensions (W x H x D)	8.4" x 3.5" x 13" (213 x 88 x 330 mm)	
Weight	11 lbs (5 kg)	
Warranty	3 Years	
Standard Accessories	Power cord & certificate of calibration	
Optional Accessories	Rack mount kit (RK2US)	

Regulatory Compliance	
Safety	Low Voltage Directive (LVD) 2014/35/EU, EN61010-1:2010, cTUVus certification mark ⁽⁵⁾ fulfills US (UL 61010-1:2012) and Canadian (CAN/CSA-C22.2 NO. 61010-1-12) safety standards
Electromagnetic Compatibility	EMC Directive 2014/30/EU, EN61326-1:2013

- (1) With remote sense terminal connected.
- (2) From 10% to 90% or from 90% to 10% of total voltage excursion.
- (3) Time for output voltage to recover within 0.5% of its rated output for a load change 50-100% of full load.
- (4) Typical time required for output to begin to change following receipt of command data.
- (5) Tested and certified by a Nationally Recognized Testing Laboratory (NRTL), accredited by OSHA.

Ordering Information

9240 Series Power Supplies

Model	Description
9240	32 V / 8 A, 120 W
9240-GPIB	32 V / 8 A, 120 W with GPIB
9241	60 V / 4 A, 120 W
9241-GPIB	60 V / 4 A, 120 W with GPIB
9242	60 V / 10 A, 200 W
9242-GPIB	60 V / 10 A, 200 W with GPIB

Service Information

Warranty Service: Please go to the support and service section on our website at bkprecision.com to obtain an RMA #. Return the product in the original packaging with proof of purchase to the address below. Clearly state on the RMA the performance problem and return any leads, probes, connectors and accessories that you are using with the device.

Non-Warranty Service: Please go to the support and service section on our website at bkprecision.com to obtain an RMA #. Return the product in the original packaging to the address below. Clearly state on the RMA the performance problem and return any leads, probes, connectors and accessories that you are using with the device. Customers not on an open account must include payment in the form of a money order or credit card. For the most current repair charges please refer to the service and support section on our website.

Return all merchandise to B&K Precision Corp. with prepaid shipping. The flat-rate repair charge for Non-Warranty Service does not include return shipping. Return shipping to locations in North America is included for Warranty Service. For overnight shipments and non-North American shipping fees please contact B&K Precision Corp.

Include with the returned instrument your complete return shipping address, contact name, phone number and description of problem.

B&K Precision Corp.
22820 Savi Ranch Parkway
Yorba Linda, CA 92887
bkprecision.com
714-921-9095

LIMITED THREE-YEAR WARRANTY

B&K Precision Corp. warrants to the original purchaser that its products and the component parts thereof, will be free from defects in workmanship and materials for a period of **three years** from date of purchase. B&K Precision Corp. will, without charge, repair or replace, at its option, defective product or component parts. Returned product must be accompanied by proof of the purchase date in the form of a sales receipt.

To help us better serve you, please complete the warranty registration for your new instrument via our website www.bkprecision.com

Exclusions: This warranty does not apply in the event of misuse or abuse of the product or as a result of unauthorized alterations or repairs. The warranty is void if the serial number is altered, defaced or removed.

B&K Precision Corp. shall not be liable for any consequential damages, including without limitation damages resulting from loss of use. Some states do not allow limitations of incidental or consequential damages. So the above limitation or exclusion may not apply to you.

This warranty gives you specific rights and you may have other rights, which vary from state-to-state.

B&K Precision Corp.
22820 Savi Ranch Parkway
Yorba Linda, CA 92887
www.bkprecision.com
714-921-9095

Version: March 14, 2023