

User Manual

HVL Series

High Voltage DC Electronic Loads



Contents

1	Compliance Information	5
1.1	EMC	5
1.2	Safety	6
1.3	IEC Measurement Category & Pollution Degree Definitions	6
1.4	Product End-of-Life Handling	7
1.5	Terms and Symbols	7
2	Safety Notices	9
3	Introduction	15
3.1	Overview	15
3.2	Features	16
3.3	Package Contents	17
3.4	Dimensions	18
3.5	Clearance Requirement	20
3.6	Front Panel Overview	21
3.7	Rear Panel Overview	22
4	Getting Started	23
4.1	Input Power and Fuse Requirements	23
4.2	Fuse Requirements and Replacements	24
4.3	Input Connection	25
4.3.1	Current Carrying Capacity	25
4.3.2	Noise and Impedance Effects	26
4.4	Local/Remote Sense	27
4.5	Preliminary Check	28
5	Front Panel Operation	30
5.1	Keys	30
5.1.1	Function Keys	30
5.1.2	Softkeys	30
5.1.3	Programmable Keys and ESC	31
5.1.4	Numeric Keys	31
5.1.5	Input Control	32
5.1.6	Navigation Keys and Screenshots	32
6	Operation Modes	33
6.1	Load Modes	34
6.1.1	CC Mode	35
6.1.2	CV Mode	36

6.1.3	CR Mode	38
6.1.4	CW Mode	39
6.1.5	Short Mode	40
6.1.6	Ranges	41
6.2	Transient Operation	42
6.2.1	Configure Transient Mode	42
6.2.1.1	Continuous Transient Mode	44
6.2.1.2	Pulse Transient Mode	46
6.2.1.3	Toggle Transient Mode	48
6.3	List Mode	50
6.3.1	List Setup	51
6.3.2	Edit List	54
6.4	Analog Digital I/O Connector	57
6.4.1	Digital Output Control	60
6.4.2	Analog State	62
6.5	Parallel Mode	64
6.6	Rise/Fall Measurement Settings	68
7	Input Configuration	69
7.1	Over Protection	70
7.1.1	Overvoltage Protection (OVP)	70
7.1.2	Overcurrent Protection (OCP)	70
7.1.3	Overpower Protection (OPP)	70
7.2	Input Settings	72
7.2.1	Remote Sense	72
7.2.2	Timer State and Setting	72
7.2.3	Slew Rise/Slew Fall (A/ms)	73
7.2.4	On/Off Delay	73
7.2.5	Loop Response and CR Control	74
7.2.6	Oscillation Protection	74
7.2.7	Averaging	75
7.2.8	Soft Start	75
8	Data Logger	77
8.1	Configuring the Data Logger	77
9	Utility Menu	83
9.1	User Settings	84
9.1.1	Key Lock Input	84
9.1.2	Beep Sound	84
9.1.3	Shortcuts	85
9.1.4	Date and Time	85
9.1.5	Screen Intensity	85
9.1.6	Configuring User Settings	86

9.2	Remote Interfaces	87
9.2.1	USB	87
9.2.2	LAN	89
9.2.3	Configuring LAN Settings	90
9.3	LAN Status	91
9.4	GPIB	92
9.5	Test/Admin	93
9.5.1	Self-Test	93
9.5.2	Security	94
9.6	Error Log	96
9.6.1	Saving the Error Log	97
9.6.2	Clear the Error Log	97
9.7	Help	98
10	Specifications	100
11	Service Information	102
12	LIMITED THREE-YEAR WARRANTY	103

Compliance Information

1.1 EMC

EC Declaration of Conformity - EMC

Compliance was demonstrated to the following specifications listed in the Official Journal of the European Communities: EMC Directive 2014/30/EU.

EN 61000-3-2: 2006 Electromagnetic compatibility (EMC) - Part 3-2: Limits - Limits for harmonic current emissions (equipment input current ≤ 16 A per phase)

EN 61000-3-3: 1995+A1: 2001+A2: 2005 Electromagnetic compatibility (EMC) - Part 3-3: Limits - Limitation of voltage changes, voltage fluctuations and flicker in public low-voltage supply systems, for equipment with rated current ≤ 16 A per phase and not subject to conditional connection

EN 61000-4-2 / -3 / -4 / -5 / -6 / -11 Electromagnetic compatibility (EMC) - Part 4-2: Testing and measurement techniques:

- Electrostatic discharge immunity test
- Radiated, radio-frequency, electromagnetic field immunity test
- Electrical fast transient/burst immunity test
- Surge immunity test
- Immunity to conducted disturbances, induced by radio-frequency fields
- Voltage dips, short interruptions and voltage variations immunity tests for equipment with input current up to 16 A per phase

EN 61326-1: 2006 Electrical equipment for measurement, control and laboratory use - EMC requirements - Part 1: General requirements

1.2 Safety

EC Declaration of Conformity - Low Voltage

Compliance was demonstrated to the following specification as listed in the Official Journal of the European Communities: Low Voltage Directive: 2006/95/EC .

EN61010-1: 2001 Safety requirements for electrical equipment for measurement, control, and laboratory use - Part 1: General requirements

1.3 IEC Measurement Category & Pollution Degree Definitions

Measurement Category (CAT) - classification of testing and measuring circuits according to the types of mains circuits to which they are intended to be connected.

Measurement Category other than II, III, or IV : circuits that are not directly connected to the mains supply.

Measurement Category II (CAT II) : test and measuring circuits connected directly to utilization points (socket outlets and similar prints) of the low-voltage mains installation.

Measurement Category III (CAT III) : test and measuring circuits connected to the distribution part of a building's low-voltage mains installation.

Measurement Category IV (CAT IV) : test and measuring circuits connected at the source of the building's low-voltage mains installation.

Mains Isolated : is for measurements performed on circuits not directly connected to a mains supply.

Pollution - addition of foreign matter, solid, liquid, or gaseous (ionized gases) that may produce a reduction of dielectric strength or surface resistivity.

Pollution Degree 2 (P2) - only non-conductive pollution occurs except that occasionally a temporary conductivity caused by condensation is expected

1.4 Product End-of-Life Handling

The equipment may contain substances that could be harmful to the environment or human health if improperly handled at the product's end of life. To avoid release of such substances into the environment and to reduce the use of natural resources, we encourage you to recycle this product to an appropriate system that will ensure that most of the materials are reused or recycled appropriately.



This product is subject to Directive 2012/19/EU of the European Parliament and the Council of the European Union on waste electrical and electronic equipment (WEEE), and in jurisdictions adopting that Directive, is marked as being put on the market after August 13, 2005, and should not be disposed of as unsorted municipal waste. Please utilize your local WEEE collection facilities in the disposition of this product.

1.5 Terms and Symbols

Terms



A caution statement calls attention to an operating procedure, practice, or condition, which, if not followed correctly, could result in damage to or destruction of parts or the entire product.



A warning statement calls attention to an operating procedure, practice, or condition, which, if not followed correctly, could result in injury or death to personnel.



A note statement calls attention to an operating procedure, practice, or condition, which, should be noted before proceeding.

Symbols



WARNING - HIGH VOLTAGE - possibility of electric shock.



CAUTION – Statements or instructions that must be consulted in order to find out the nature of the potential hazard and any actions which must be taken.



On (Supply). This is the AC mains connect/disconnect switch on the front of the instrument.



Off (Supply). This is the AC mains connect/disconnect switch on the front of the instrument.



Alternating current



Chassis (earth ground) symbol



Earth (ground) TERMINAL - Refer to the instructions accompanying this symbol in this manual.

Safety Notices

The following safety precautions apply to both operating and maintenance personnel and must be followed during all phases of operation, service, and repair of this instrument.

Before applying power to this instrument:

- Read and understand the safety and operational information in this manual.
- Apply all the listed safety precautions.
- Verify that the voltage selector at the line power cord input is set to the correct line voltage. Operating the instrument at an incorrect line voltage will void the warranty.
- Make all connections to the instrument before applying power.
- Do not operate the instrument in ways not specified by this manual or by B&K Precision.

Failure to comply with these precautions or with warnings elsewhere in this manual violates the safety standards of design, manufacture, and intended use of the instrument. B&K Precision assumes no liability for a customer's failure to comply with these requirements.

Electrical Power

This instrument is intended to be powered from a CATEGORY II mains power environment. The mains power should be 115 V RMS or 230 V RMS. Use only the power cord supplied with the instrument and ensure it is appropriate for your country of use.



Do not use this instrument in an electrical environment with a higher category rating than what is specified in this manual for this instrument.



You must ensure that each accessory you use with this instrument has a category rating equal to or higher than the instrument's category rating to maintain the instrument's category rating. Failure to do so will lower the category rating of the measuring system.

Ground the Instrument

⚠ WARNING

To minimize shock hazard, the instrument chassis and cabinet must be connected to an electrical safety ground. This instrument is grounded through the ground conductor of the supplied, three-conductor AC line power cable. The power cable must be plugged into an approved three-conductor electrical outlet. The power jack and mating plug of the power cable meet IEC safety standards.

⚠ WARNING

Do not alter or defeat the ground connection. Without the safety ground connection, all accessible conductive parts (including control knobs) may provide an electric shock. Failure to use a properly-grounded approved outlet and the recommended three-conductor AC line power cable may result in injury or death.

⚠ WARNING

Unless otherwise stated, a ground connection on the instrument's front or rear panel is for a reference of potential only and is not to be used as a safety ground. Do not operate in an explosive or flammable atmosphere.

Environmental Conditions

This instrument is intended to be used in an indoor pollution degree 2 environment. The operating temperature range is 0°C to 40°C and 20% to 80% relative humidity, with no condensation allowed.

Measurements made by this instrument may be outside specifications if the instrument is used in non-office-type environments. Such environments may include rapid temperature or humidity changes, sunlight, vibration and/or mechanical shocks, acoustic noise, electrical noise, strong electric fields, or strong magnetic fields.



Do not operate the instrument in the presence of flammable gases or vapors, fumes, or finely-divided particulates.

The instrument is designed to be used in office-type indoor environments. Do not operate the instrument

- **In the presence of noxious, corrosive, or flammable fumes, gases, vapors, chemicals, or finely-divided particulates.**
 - **In relative humidity conditions outside the instrument's specifications.**
 - **In environments where there is a danger of any liquid being spilled on the instrument or where any liquid can condense on the instrument.**
 - **In air temperatures exceeding the specified operating temperatures.**
 - **In atmospheric pressures outside the specified altitude limits or where the surrounding gas is not air.**
 - **In environments with restricted cooling air flow, even if the air temperatures are within specifications.**
 - **In direct sunlight.**
-



Do not operate instrument if damaged

! WARNING

If the instrument is damaged, appears to be damaged, or if any liquid, chemical, or other material gets on or inside the instrument, remove the instrument's power cord, remove the instrument from service, label it as not to be operated, and return the instrument to B&K Precision for repair. Notify B&K Precision of the nature of any contamination of the instrument.

! WARNING

Hazardous voltages may be present in unexpected locations in circuitry being tested when a fault condition in the circuit exists.

Clean the instrument only as instructed

! WARNING

Do not clean the instrument, its switches, or its terminals with contact cleaners, abrasives, lubricants, solvents, acids/bases, or other such chemicals. Clean the instrument only with a clean dry lint-free cloth or as instructed in this manual. Not for critical applications.

Do not touch live circuits



Instrument covers must not be removed by operating personnel. Component replacement and internal adjustments must be made by qualified service-trained maintenance personnel who are aware of the hazards involved when the instrument's covers and shields are removed. Under certain conditions, even with the power cord removed, dangerous voltages may exist when the covers are removed.

To avoid injuries, always disconnect the power cord from the instrument, disconnect all other connections (for example, test leads, computer interface cables, etc.), discharge all circuits, and verify there are no hazardous voltages present on any conductors by measurements with a properly-operating voltage-sensing device before touching any internal parts. Verify the voltage-sensing device is working properly before and after making the measurements by testing with known-operating voltage sources and test for both DC and AC voltages.

Do not attempt any service or adjustment unless another person capable of rendering first aid and resuscitation is present.

General Safety



Do not insert any object into an instrument's ventilation openings or other openings.



This instrument is not authorized for use in contact with the human body or for use as a component in a life-support device or system.

Servicing

⚠ WARNING

Do not substitute parts that are not approved by B&K Precision or modify this instrument. Return the instrument to B&K Precision for service and repair to ensure that safety and performance features are maintained.

⚠ WARNING

Fuse replacement must be done by qualified service-trained maintenance personnel who are aware of the instrument's fuse requirements and safe replacement procedures. Disconnect the instrument from the power line before replacing fuses. Replace fuses only with new fuses of the fuse types, voltage ratings, and current ratings specified in this manual or on the back of the instrument. Failure to do so may damage the instrument, lead to a safety hazard, or cause a fire. Failure to use the specified fuses will void the warranty.

For continued safe use of the instrument

- Do not place heavy objects on the instrument.
- Do not obstruct cooling air flow to the instrument.
- Do not place a hot soldering iron on the instrument.
- Do not pull the instrument with the power cord, connected probe, or connected test lead.
- Do not move the instrument when a probe is connected to a circuit being tested.

Introduction

3.1 Overview

The HVL Series DC Electronic Loads are versatile instruments used for static and dynamic testing of DC power supplies, batteries, DC-to-DC converters, and battery chargers. Other applications include fuel-cell and photovoltaic cell test.

The DC load can be used in one of the following operation modes: constant voltage (CV), constant current (CC), constant resistance (CR), or constant power (CW). A wide range of dynamic loading applications can be simulated through user-programmable slew rates, load levels, duration, and conducting voltage. The DC load can be remotely programmed via the USB, GPIB, LAN, or RS-232 serial interface. Versatile triggering options allow the dynamic load behavior to be synchronized with other events.

A battery test mode is provided that will measure the ampere-hour (Ah) characteristic of a battery. Shorts can be simulated by either the front panel or custom programming. The DC source or other components can be protected from excessive voltage, current, or power, which will cause the DC load to shut down if excessive levels or reverse polarity are detected.

Model	Max. Input	Max. Input	Max. Input Power
HVL600150	600 V	150 A	3000 W
HVL600300	600 V	300 A	6000 W
HVL80075	800 V	75 A	3000 W
HVL800150	800 V	150 A	6000 W
HVL100025	1000 V	25 A	3000 W
HVL100050	1000 V	50 A	6000 W

Table 3.1 HVL Series Models

3.2 Features

- Highest power density of 1.2 kW per 1U rack space
- Input voltage up to 1 kV
- Current range 25 A - 300 A
- CC/CV/CR/CP operating modes
- 0.05% CC mode readback accuracy
- Master/Slave parallel operation
- Transient mode up to 10 kHz
- Programmable slew rate
- OVP/OCP/OPP/OTP/ and reverse current protection

3.3 Package Contents

Please inspect the instrument mechanically and electrically upon receiving it. Unpack all items from the shipping carton, and check for any obvious signs of physical damage that may have occurred during transportation. Report any damage to the shipping agent immediately. Save the original packing carton for possible future reshipment. Every electronic load is shipped with the following contents:

- 1 x HVL DC Electronic Load
- 1 x AC Power Cord
- 1 x Certificate of Calibration

NOTICE

Verify that all items above are included in the shipping container. If anything is missing, please contact B&K Precision.

3.4 Dimensions

The HVL Series dimensions are approximately.

Model	Dimensions (W x H x D)	Weight
HVL 3 kW 3U	478.0 mm x 152.8 mm x 665.0 mm	48.5 lbs (22 kg)
HVL 6 kW 5U	478.0 mm x 241.8 mm x 615.0 mm	73.8 lbs (33.5 kg)

Table 3.2 Dimensions and Weight

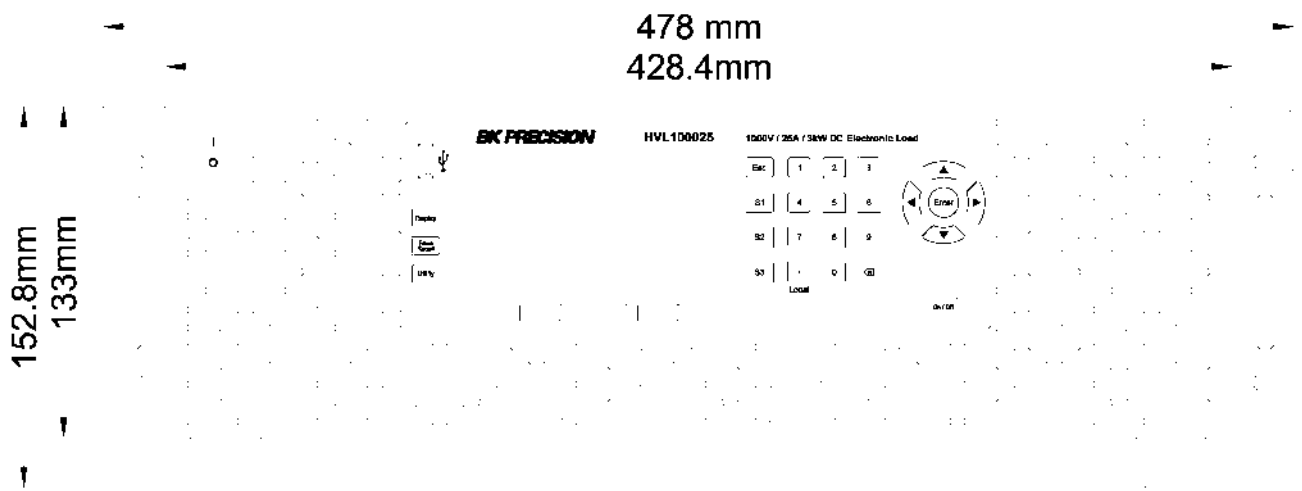

Figure 3.1 Front View HVL 3 kW 3U

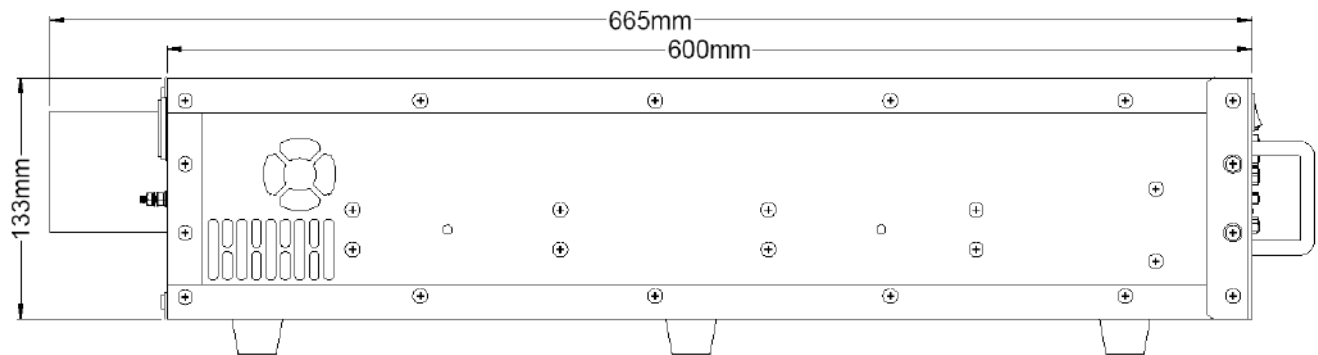

Figure 3.2 Side View HVL 3 kW 3U

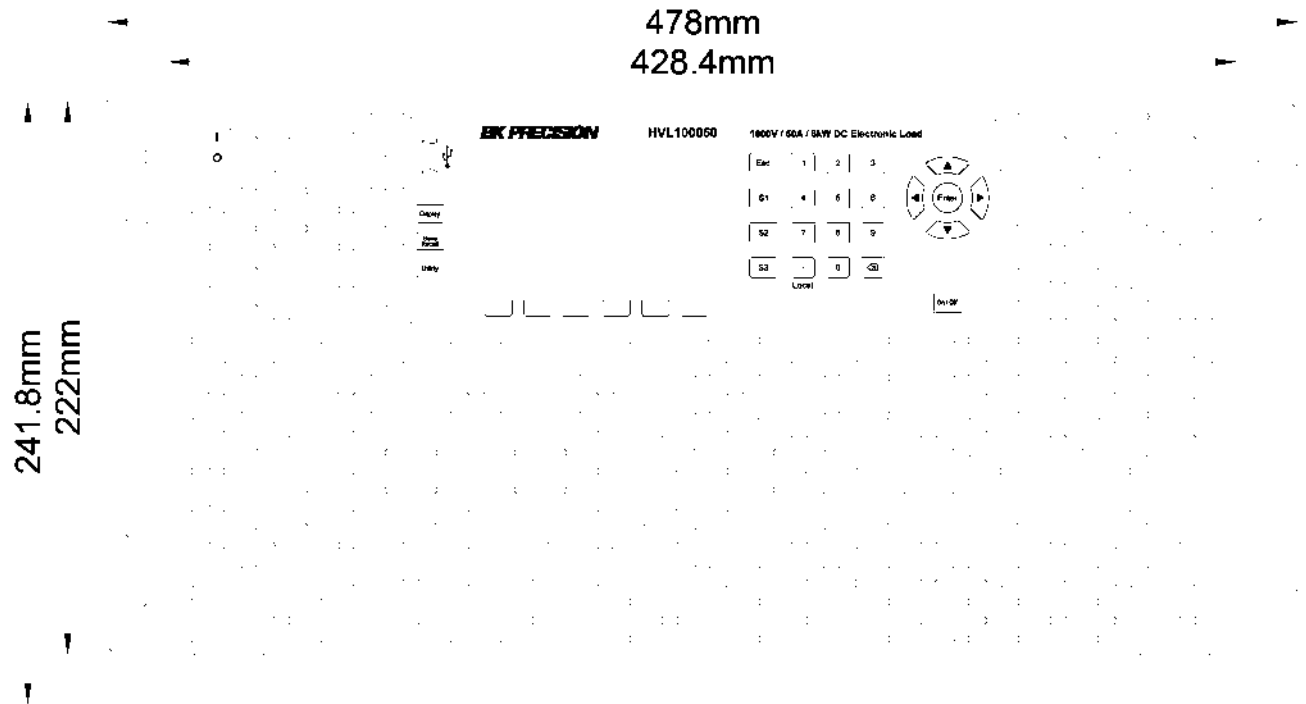

Figure 3.3 Front View HVL 6 kW 5U

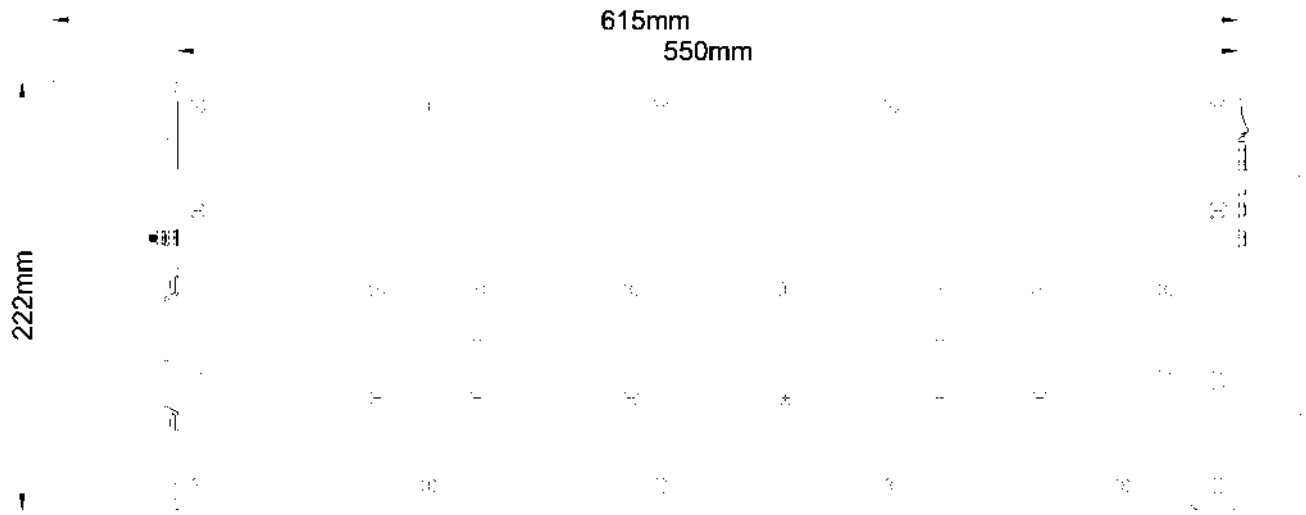

Figure 3.4 Side View HVL 6 kW 5U

3.5 Clearance Requirement

The electronic load draws power from the DUT, generating heat equivalent to the power consumed. Hence, it's crucial to provide sufficient clearance for the electronic load. The HVL series is an air-cooled electronic load with front intake and rear exhaust. During installation, caution must be exercised to ensure that the hot air expelled at the rear does not circulate back to the front intake. Failure to prevent this could lead to over temperature protection (OTP) issues, causing the electronic load to cease operation. Refer to [figure 3.5](#) for the specified clearance requirements for the electronic load.

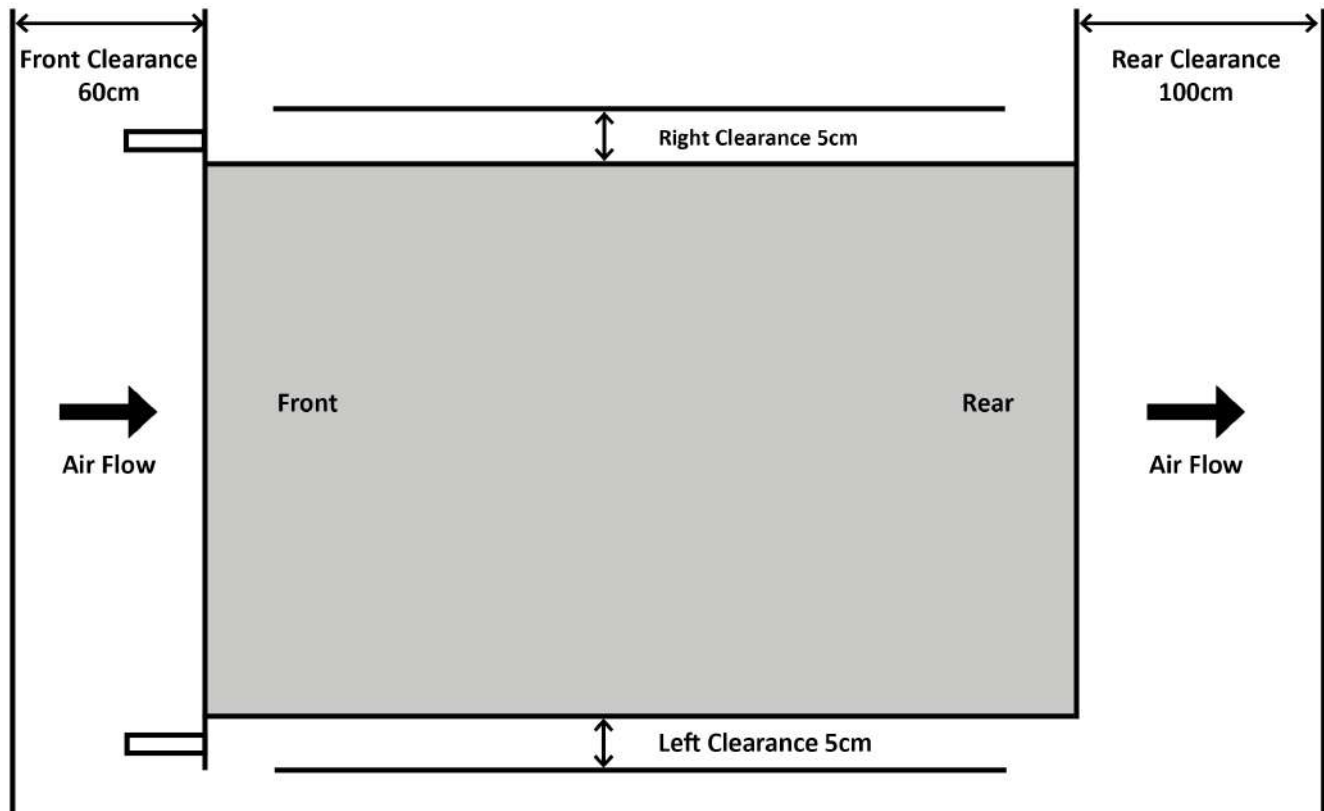

Figure 3.5 Clearance Requirement

3.6 Front Panel Overview



Figure 3.6 Front Panel Overview

Item	Name	Description
1	Power Button	Toggles the instrument ON or OFF.
2	USB Host Port	USB port used to connect a flash drive.
3	Function Keys	See section 5.1.1 for details.
4	Softkeys	Used to invoke any functions displayed above them.
5	Programmable Keys	See section 5.1.3 for details.
6	Numeric Keypad	Used to enter precise values.
7	Navigation Keys	Used to navigate menus or configure parameters.
8	Input Power Button	Toggles the input ON or OFF

Table 3.3 Front Panel Overview

3.7 Rear Panel Overview

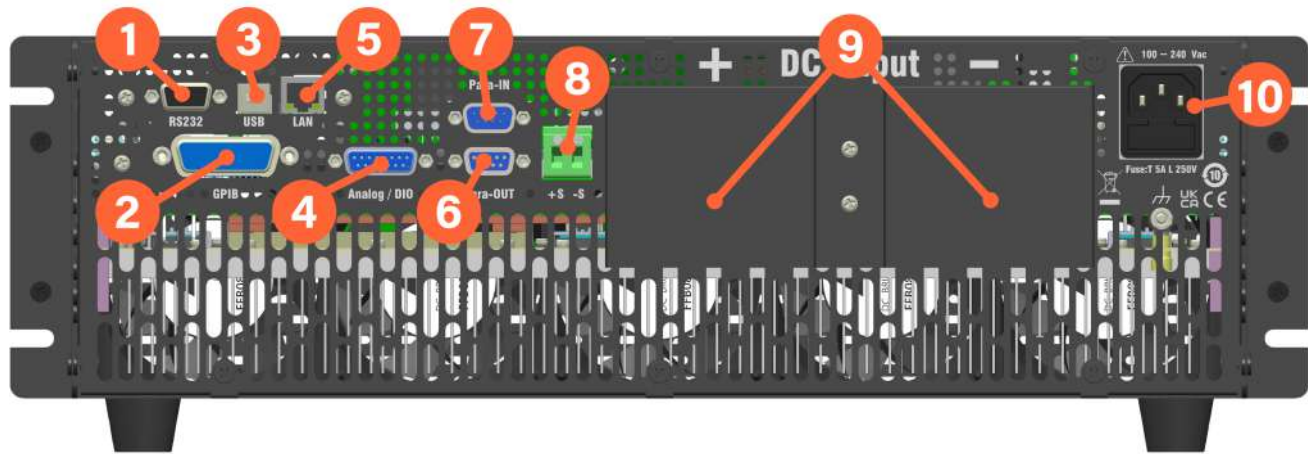

Figure 3.7 Rear Panel Overview

Item	Name	Description
1	RS232	Connect a RS232 cable to remotely control the unit.
2	GPIB	Connect a GPIB cable to remotely control the unit.
3	USB interface	Connect a USB type B to type A to remotely control the unit.
4	Analog/DIO	Hardware connection external analog control.
5	LAN interface	Connect a Cat 5/6 Ethernet straight-through patch cable to remotely control the unit.
6	Para-OUT	DB9 connector which provides the synchronization signal for parallel operations.
7	Para-IN	DB9 connector input for the synchronization signal used in parallel operations.
8	Sense	Remote Sense terminals
9	Input	Input protection cover.
10	AC power input & fuse box	Houses the fuse as well as the AC input.

Table 3.4 Rear Panel Overview

Getting Started

Before connecting and powering up the instrument, please review the instructions in this chapter.

4.1 Input Power and Fuse Requirements

The supply has a universal AC input that accepts line voltage input within:

	3 kW 3U Models	6 kW 5U Models
AC Line Input	100 - 240 Vac, 50/60 Hz	
AC Line Phase	Single Phase	
Maximum Rated Input Power	250 VA	400 VA

Before connecting to an AC outlet or external power source, be sure that the power switch is in the OFF position and verify that the AC power cord, including the extension line, is compatible with the rated voltage/current and that there is sufficient circuit capacity for the dc load. Once verified, connect the cable firmly.



The included AC power cord is safety certified for this instrument operating in rated range. To change a cable or add an extension cable, be sure that it can meet the required power ratings for this instrument. Any misuse with wrong or unsafe cables will void the warranty.



The power cord provides a chassis ground through a third conductor. Verify that your power outlet is of the three-conductor type with the correct pin connected to earth ground.

AC POWER CORD SPECIFICATION

Wire Size: 16AWG

Conductor Type: SJT

Rating: 105°C

Length: <3m

4.2 Fuse Requirements and Replacements

An AC input fuse is necessary when powering the instrument. All models in the HVL series require a Time delay low breaking capacity 5A/250V (T 5A L 250V).

! WARNING

For safety, no power should be applied to the instrument while changing line voltage operation. Disconnect all cables connected to the instrument before proceeding.

1. Locate the fuse box next to the AC input connector in the rear panel. (See figure 3.7)
2. Insert a small flathead screwdriver into the fuse box slit to pull and slide out the fuse box.
3. Check and replace fuse if necessary. (See figure 4.1)

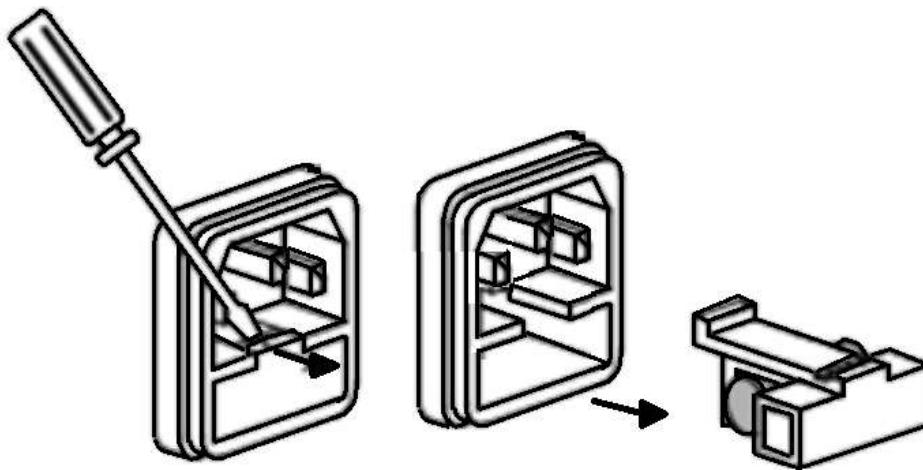

Figure 4.1 Fuse Removal

! WARNING

Any disassembling of the case or changing the fuse not performed by an authorized service technician will void the warranty of the instrument.



Hazardous voltages may exist at the outputs and the load connections when using a power supply with a rated output greater than 60 V. To protect personnel against accidental contact with hazardous voltages, ensure that the load and its connections have no accessible live parts. Ensure that the load wiring insulation rating is greater than to the maximum output voltage of the power supply.

4.3 Input Connection

The electronic load input terminals use M10 screws and nuts or M6 screws threads to connect to the input source. It is recommended to use the proper wire and lug for the load wiring. The following factors are needed to take into consideration:

- Insulation rating of the wire
- Current carrying capacity of the wire
- Noise and impedance effects of the load lines
- Maximum load wiring length for remote sense operation

4.3.1 Current Carrying Capacity

As a minimum, load wiring must have a current capacity greater than the output current rating of the power source. This ensures that the wiring will not be damaged even if the load is shorted.

Table 4.3.1 shows the maximum current rating, based on 450 A/cm², for various gauges of wire rate for 105°C operations. Operating at the maximum current rating results in an approximately 30°C temperature rise for a wire operating in free air.

When load wiring must operate in areas with elevated ambient temperatures or bundled with other wiring, use larger gauges or wiring rated for higher temperature.

Wire Size AWG	2/0	1/0	1	2	4	6	8	10	12	14
Max. Current(A)	303	247	192	155	97	61	36	21	16	10

Table 4.1 Current Carrying Capacity



Hazardous voltages may exist at the input terminals with a power source output greater than 40V. To protect personnel against accidental contact with hazardous voltages, ensure that the power source and its connections have no accessible live parts. Ensure that the load wiring insulation rating is greater than to the maximum output voltage of the power source. And, use the input protection cover.

4.3.2 Noise and Impedance Effects

To minimize noise pickup or radiation interference, use a shielded pair wiring or the shortest possible length for load wires. Connect the shield to the chassis via a rear panel mounting screw.

If shielding is impossible or impractical, simply twisting the wires together will offer some noise immunity. When using local sense connections, the user must use the largest practical wire size to minimize the effects of load line impedance on the regulation of the load.

4.4 Local/Remote Sense

The electronic load is capable of sensing voltage locally or remotely. If the load wiring is relatively short and the load regulation is not critical, local sense configuration is good enough. On the other hand, if the load wiring is relatively long, configuring to remote sense will compensate for the voltage drop of the long load leads. Below are figures for local and remote sense configurations.

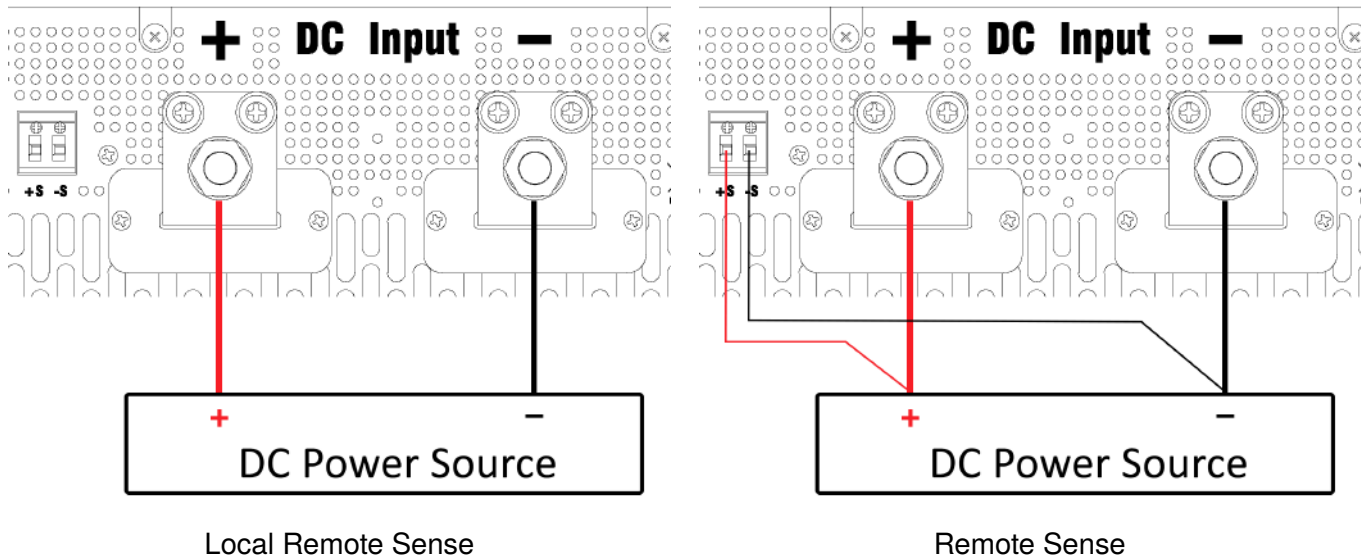

Figure 4.2 Local/Remote Sense

To configure the local or remote sense:

- Step 1.** Press the **Utility** softkey to view the utility menu.
- Step 2.** Press the **Input Config** softkey.
- Step 3.** Press the **Input Settings** softkey.
- Step 4.** Press the **Remote Sense** softkey to toggle the remote sense state.

NOTICE

To prevent oscillation or noise interference, it is recommended to twist the remote sense + and – leads.

4.5 Preliminary Check

Complete the following steps to verify the Power supply is ready for use.

Verify AC Input Voltage

Verify and check to make sure proper AC voltages are available to power the instrument. The AC voltage range must meet the acceptable specification as explained in section “**2.1 Input Power and Fuse Requirements**”.

Connect Power & Self-Test

Connect AC power cord to the AC receptacle in the rear panel and press the power button. It will run through a self-test procedure initially before booting to the main screen.

After Power on, during the self-test, the following should be displayed:

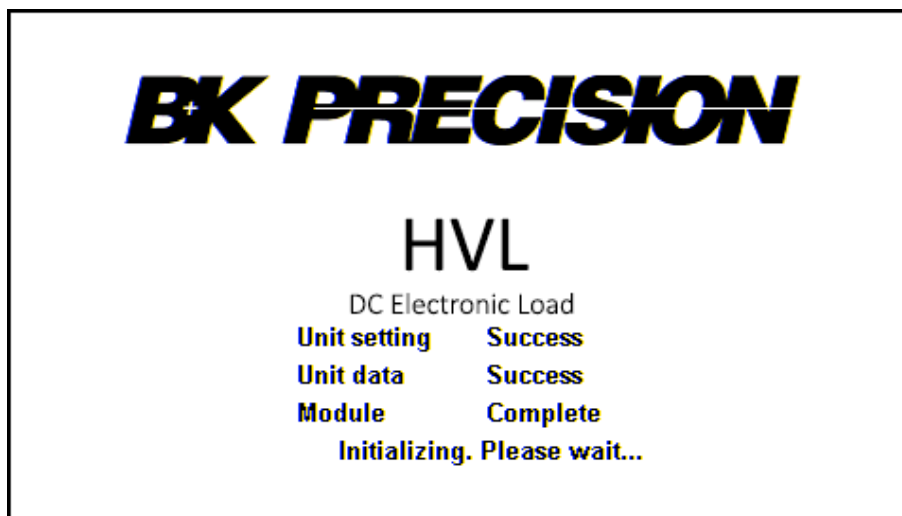

Figure 4.3 Initializing

After the system scan is complete the LCD will display as shown in **Figure 4.4**

NOTICE

The initial power on state is based on the settings set on Power-ON

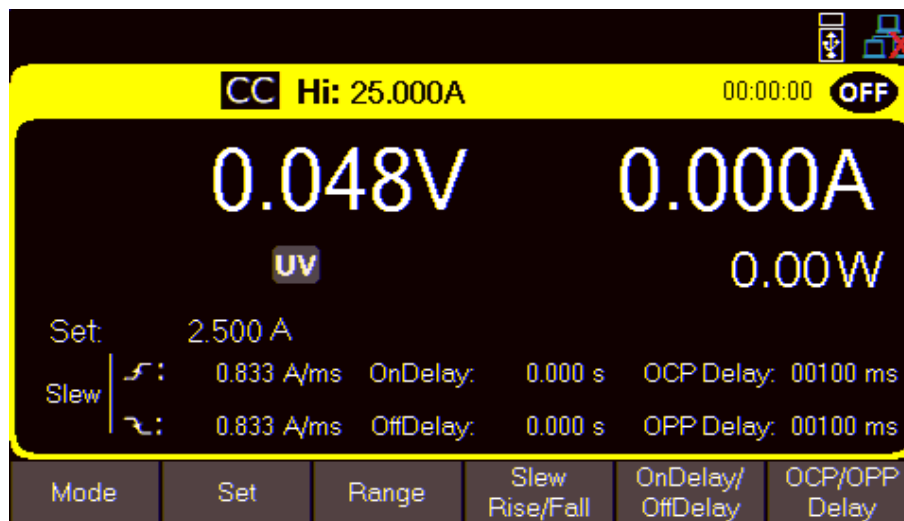

Figure 4.4 Home Display

NOTICE

The HVL series is fully operable upon switching the power ON. However, to reach the specified equipment accuracy, please allow the electronic load to warm up for at least 15 minutes.

Front Panel Operation

At power-on, the power supply will automatically enter the front-panel operation mode and the instrument can be controlled via the front panel keys and knob.

5.1 Keys

5.1.1 Function Keys

There are three function keys:

Display

When navigating any menu the **Display** key will return to the main display.

Save Recall

Opens up a menu giving access to various save and load options, regardless of the current display of the screen.

Utility

Opens the main menu bar. Pressing **Utility** will navigate to the main menu bar if any menu bar is already open.

5.1.2 Softkeys

The unit has six soft keys, which are located beneath the screen. Each key selects the corresponding function. Functions will vary depending on the current menu or display.



Figure 5.1 Soft Keys

5.1.3 Programmable Keys and ESC

The instrument provides three programmable keys. These keys are specialized buttons that can be assigned to perform specific functions or trigger predefined actions. The programmable keys are labeled **S1**, **S2**, and **S3**.

These keys provide users with the flexibility to personalize their experience by assigning frequently used commands. The Default values for each key are as follow:

- **S1** : Transient Trigger Settings Menu
- **S2** : List Setup Menu
- **S3** : Help Menu

For more information on how to program each programmable key refer to [section 9.1](#).

The **ESC** key is located on the same column as the programmable keys. Pressing the **ESC** will exit the currently selected parameter or menu. If a parameter is chosen the configuration of the parameters will be exited without saving any values that may have been adjusted after entering the parameter configuration.

When viewing a menu pressing the **ESC** key will return the user to the previous menu.

5.1.4 Numeric Keys

The numeric keys allow for the configuration of the currently selected parameter. Using the numeric keys provides a fast and precise input.

Pressing the Enter key will assign the selected value to the desired parameter.



Figure 5.2
Programmable Keys



Figure 5.3
Numeric Keys

5.1.5 Input Control

The **ON** button toggles the input On/Off. When input is enabled, the ON button will turn green and the load will commence the loading function.



Figure 5.4 Input Control

5.1.6 Navigation Keys and Screenshots

The navigation keys are a set of keys used to navigate through parameters in menus or increase/decrease the value of the selected parameter.

The **Enter** key is included in the navigation keys and is used to select parameters or confirm input values of the selected parameter.

Screenshots can be saved to an external USB device. To take a screenshot insert a U disk into the USB interface located in the front panel, then press and hold the **Enter + Save/ Recall** keys for 3 seconds.

A saved indicator will appear in the left top portion of the display. (**Figure 5.6**)



Figure 5.5
Navigation Keys

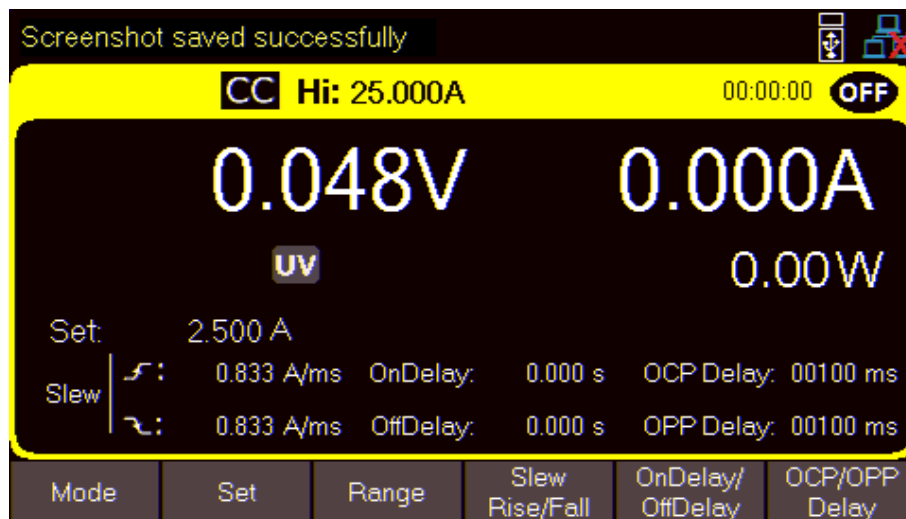

Figure 5.6
Screenshot Indicator

Operation Modes

The HVL series offers the following modes.

6.1	Load Modes	34
6.1.1	CC Mode	35
6.1.2	CV Mode	36
6.1.3	CR Mode	38
6.1.4	CW Mode	39
6.1.5	Short Mode	40
6.1.6	Ranges	41
6.2	Transient Operation	42
6.2.1	Configure Transient Mode	42
6.2.1.1	Continuous Transient Mode	44
6.2.1.2	Pulse Transient Mode	46
6.2.1.3	Toggle Transient Mode	48
6.3	List Mode	50
6.3.1	List Setup	51
6.3.2	Edit List	54
6.4	Analog Digital I/O Connector	57
6.4.1	Digital Output Control	60
6.4.2	Analog State	62
6.5	Parallel Mode	64
6.6	Rise/Fall Measurement Settings	68

6.1 Load Modes

The electronic load provides five static load modes. They are constant current (CC) mode, constant voltage (CV) mode, constant resistance (CR) mode, constant power (CP) mode and short mode.

To view the **Modes** menu return to the home page by pressing the **Display function key**, then press the F1.

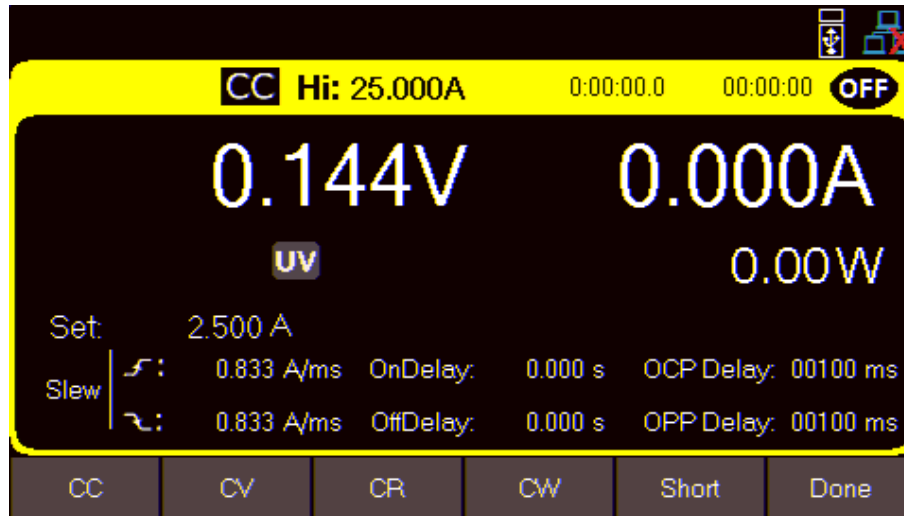

Figure 6.1 Static Modes

When programmed to a mode, the electronic load remains in that mode until another mode is selected.

NOTICE

If the selected mode is in operation, the input must first be disabled in order to change to any other **Static** mode.

6.1.1 CC Mode

In constant current mode, the load will sink a current in accordance with the programmed value regardless of the input voltage.

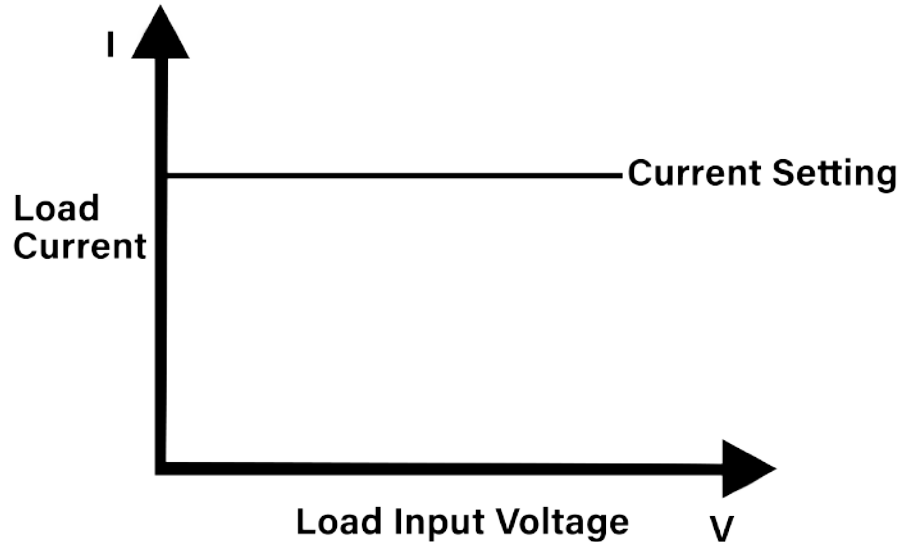

Figure 6.2 CC Mode

To select CC mode return to the home page by pressing the **Display function key**, then press the **F1 softkey** to enter the **Mode Menu**. In the **Mode Menu** press the **F1 softkey** to select CC.

Configure CC Parameters

There are several parameters that must be setup in CC mode. These parameters are accessible once CC is selected. Use the softkey to select the available parameters, then use either the **numeric keypad** or the **navigation keys** to configure the parameter.

Set

Sets the current value the load will sink.

Slew Rise/Fall A/ms

Sets the rise and fall slew rate of the load, which determines the rate at which the input current increases and decreases to a new programmed value.

6.1.2 CV Mode

In constant voltage mode the load will sink enough current to control the DUT voltage to the programmed value. The load acts as a shunt voltage regulator when operating in CV mode.

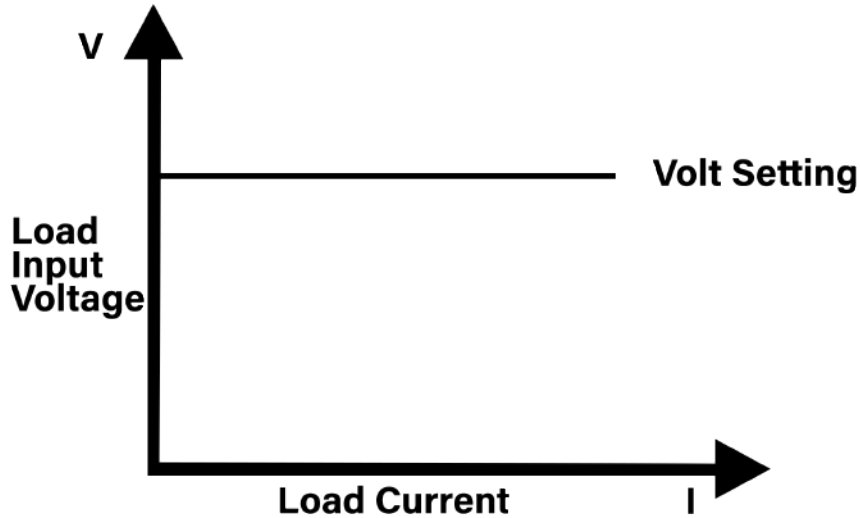

Figure 6.3 CV Mode

To select CV mode return to the home page by pressing the **Display function key**, then press the **F1 softkey** to enter the **Mode Menu**. In the **Mode Menu** press the **F2 softkey** to select CV.

Configure CV Parameters

There are several parameters that must be setup in CV mode. These parameters are accessible once CV is selected. Use the softkey to select the available parameters, then use either the **numeric keypad** or the **navigation keys** to configure the parameter.

Set

Sets the voltage value the load will maintain.

Slew Rise/Fall A/ms

Sets the rise slew rate of the load, which determines the rate at which the input voltage increases to a new programmed value.

Oscillation in CV Mode

In CV mode, the system's response speed correlates directly with three factors:

1. Equivalent output capacitance of the Device Under Test (DUT): A higher output capacitance results in slower voltage climb/fall speed.
2. Load's current sink capacity: Greater capacity leads to faster voltage drop.
3. DUT's current output capacity: Higher output capacity leads to faster voltage climb.

The potential combinations of output capacitance and output current in the DUT are practically infinite. Hence, the HVL series incorporates various loop response settings to ensure compatibility across a broad spectrum of power supplies. These settings adapt the loop response speed to the varying output capacitance values of the DUT.

In contrast to CC mode, a slower response speed doesn't necessarily diminish the likelihood of oscillation. If the power's output capacitance is extensive and the CV loop control lacks sufficient compensation, the power supply might oscillate between CC and CV modes, manifesting a gradual oscillation pattern.

The factory default setting, carefully crafted to suit most scenarios, strikes a balance between speed and caution, avoiding extremes of either excessive sluggishness or undue haste. High-Voltage Limiting is employed to maximize the "Normal" operational range within the CV loop control.

If a user encounters the aforementioned slow oscillation, switching the speed setting to "Fast" is recommended. For other abnormalities or higher frequency oscillations, adjusting the speed setting to "Low" is advised. In applications where a DC electronic load is essential for testing power supplies, a response speed capable of accommodating load transients without undue delay is essential. However, in CV mode, a universal loop response speed applicable to all DUTs or power supplies does not exist.

As a result, users must acknowledge the potential for oscillations when utilizing a load. High-power oscillations, reaching several kilowatts, pose a substantial risk, potentially causing damage to both the load and the DUT, emphasizing the importance of precautionary measures. In such cases, the HVL Series integrates an Oscillation Protection feature, offering post-oscillation adjustments to align with the user's requirements.

6.1.3 CR Mode

In constant resistance mode the load will sink a current linearly proportional to the voltage in accordance with the programmed resistance value.

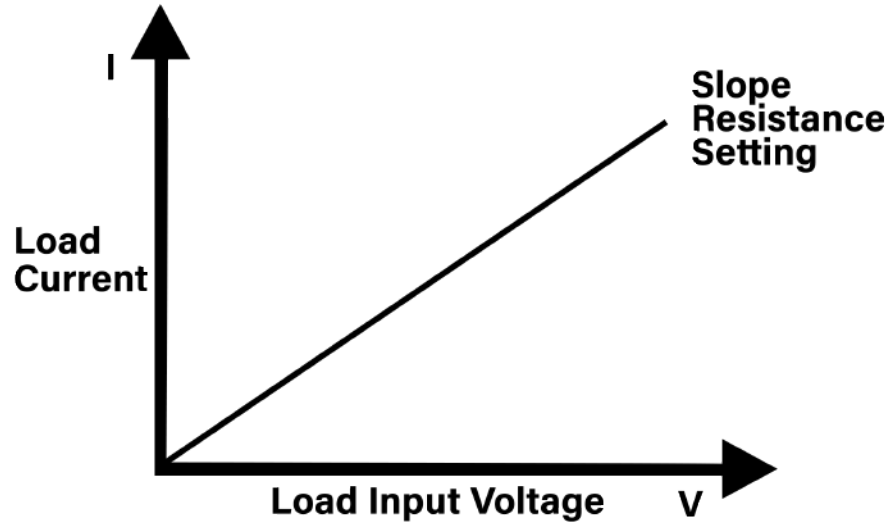

Figure 6.4 CR Mode

To select CR mode return to the home page by pressing the **Display function key**, then press the **F1 softkey** to enter the **Mode Menu**. In the **Mode Menu** press the **F3 softkey** to select CR.

Configure CR Parameters

There are several parameters that must be setup in CR mode. These parameters are accessible once CR is selected. Use the softkey to select the available parameters, then use either the **numeric keypad** or the **navigation keys** to configure the parameter.

Set

Sets the resistance value the load will maintain.

Slew Rise/Fall A/ms

Sets the rise slew rate of the load, which determines the rate at which the input current increases/decreases due to a new programmed resistance.

Free-Run/Fine-Tune

The FREE-RUN setting will set the user desired CR value once and will not change during the operation.

The FINE-TUNE setting will set the user desired CR value and continuously adjust the internal DAC from the feedback of the voltage and current to maintain more accurate CR value. For more information on how to configure this parameters please refer to [section 7.2](#).

6.1.4 CW Mode

In constant power mode the load will maintain the input power at the specified programmed power level.

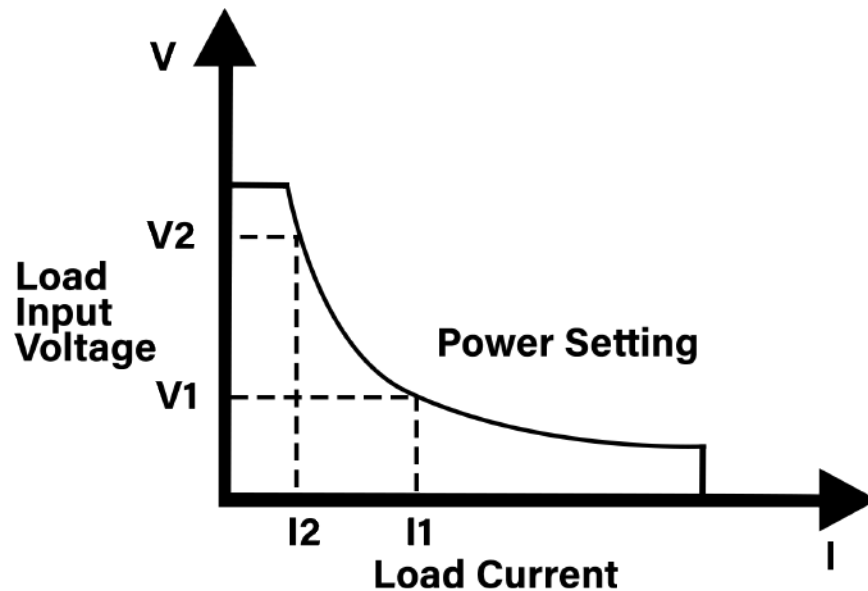

Figure 6.5 CP Mode

To select CP mode return to the home page by pressing the **Display function key**, then press the **F1 softkey** to enter the **Mode Menu**. In the **Mode Menu** press the **F4 softkey** to select CP.

Configure CW Parameters

There are several parameters that must be setup in CW mode. These parameters are accessible once CW is selected. Use the softkey to select the available parameters, then use either the **numeric keypad** or the **navigation keys** to configure the parameter.

Set

Sets the wattage value the load will maintain.

Slew Rise/Fall A/ms

Sets the rise slew rate of the load, which determines the rate at which the input current increases/decreases due to a new programmed wattage.

6.1.5 Short Mode

The HVL Series can simulate a short-circuit at the input. This allows for a short-circuit load test up to the maximum current range of the load.

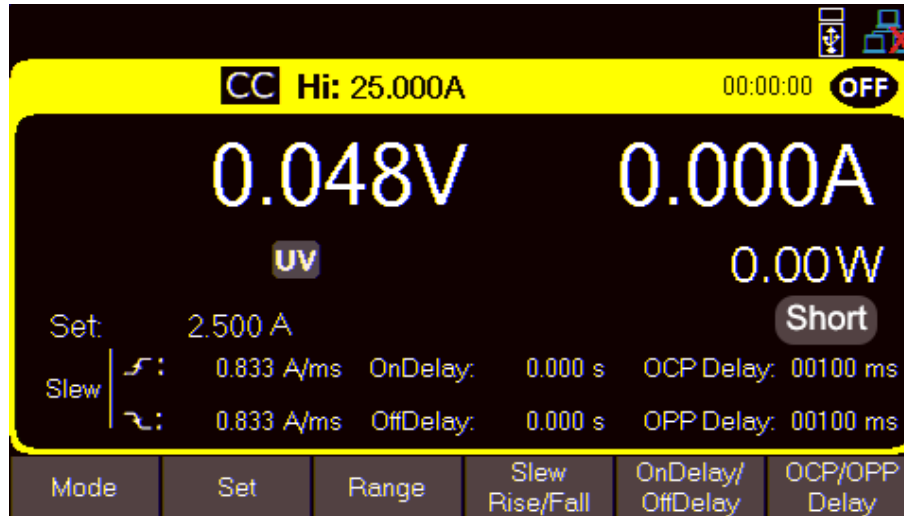

Figure 6.6 Short Mode

To select **Short** mode return to the home page by pressing the **Display function key**, then press the **F1 softkey** to enter the **Mode Menu**. In the **Mode Menu** press the **F5 softkey** to select Short.

NOTICE

The load will still report the previously selected mode. In **Figure 6.6** we can see the instrument is still displaying CC but the **Short** indicator is now present below the wattage read back.

NOTICE

The input on/off and the input protection functions take precedence over an input short.

6.1.6 Ranges

The HVL series provides three range settings; High, Low, and Custom. **Low Range** is 1/10 of the full scale, while **High Range** is full scale. **Custom (Set Range)** allows the user manually configure any range equal to or less than full scale. These ranges are all applicable to all **Static Modes**; CC, CV, CR, CW.

The range can be configured by pressing the **F3 softkey** while in the home page of the selected mode.

The selected range will be displayed in the Input Status Bar.

NOTICE

If a custom range was set, the Input Status Bar will display Lo or Hi depending on where the value falls on the full scale.

6.2 Transient Operation

Transient operation enables the module to periodically switch between two load levels. This function allows for dynamic characteristics of power supplies or other DC sources. Transient operation is available in CC, CR, CV and CP modes.

Transient testing can be used to check the stability of the source voltage. Transient functions have two current levels denoted as Level-A and Level-B, which must be in the same range. You can set the frequency as well as the duty cycle, which will affect the timing and width of each level. The slew rate determines the rate at which the level changes.

6.2.1 Configure Transient Mode

There are five 4 transient testing modes: Continuous, Toggle, Pulse, List, and Trigger. To set the transient mode follow the steps below:

Step 1. Press **Utility > Input/Seq. Mode > Transient Mode** to enter the **Transient Trigger Settings** menu.

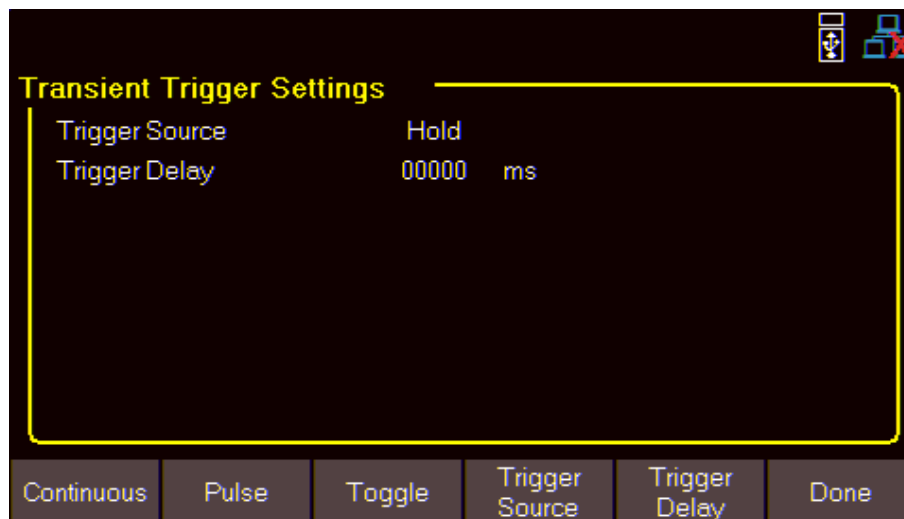

Figure 6.7 Transient Trigger Settings Menu

- Press the **F4 softkey** to configure the **Trigger Source**. Three trigger sources are available **Hold, Bus, External**
 - **Hold:** The trigger source is the press of the trigger key, either assigned to a programmable key or appears as a softkey when the trigger function becomes available (see **Figure 6.8**).
 - **Bus:** The trigger source is sent remotely using the SCPI command *TRG.
 - **External:** External triggering is offer through the Analog Digital I/O Connector. An external TTL compatible signal is used to trigger the next level of the transient mode.

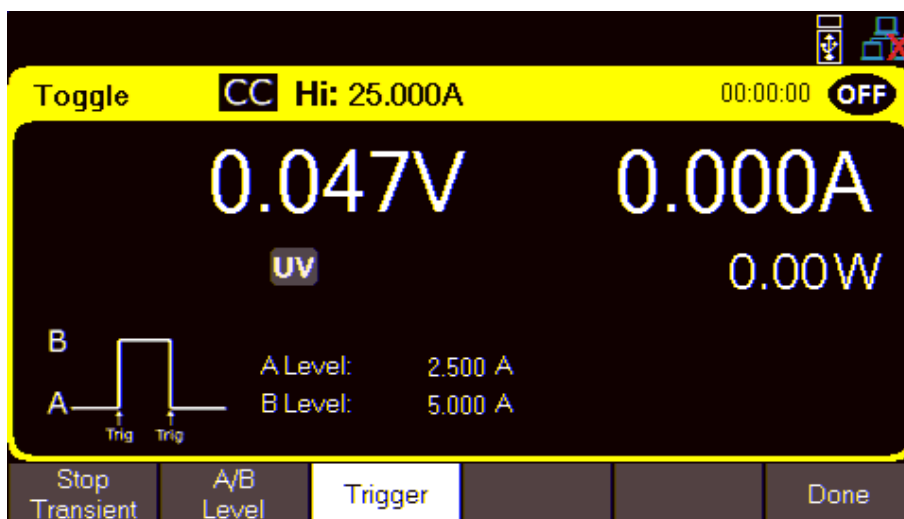

Figure 6.8 Hold Trigger Available

Step 2. Press the **F5 softkey** to configure the **Trigger Delay** function.

- Sets the delay time between the trigger being sent and the triggering function occurring.

NOTICE

The trigger parameters do not apply to continuous transient mode.

Step 3. Press the corresponding softkey to select the desired Transient mode; **Continuous (F1 Softkey)**, **Pulse (F2 Softkey)**, **Toggle (F3 Softkey)**

Step 4. Configure the parameters needed for each transient mode. (refer to the subsection of the corresponding mode.)

6.2.1.1	Continuous Transient Mode	44
6.2.1.2	Pulse Transient Mode	46
6.2.1.3	Toggle Transient Mode	48

6.2.1.1 Continuous Transient Mode

Generates a respective pulse stream that toggles between two load levels. Upon receiving a trigger, and the load will continuously switch between the A/B levels preset.

Transient loads are usually used to test the power supply's performance under continuous changing load conditions. **Figure 6.9** shows an example waveform of continuous transient operation mode.

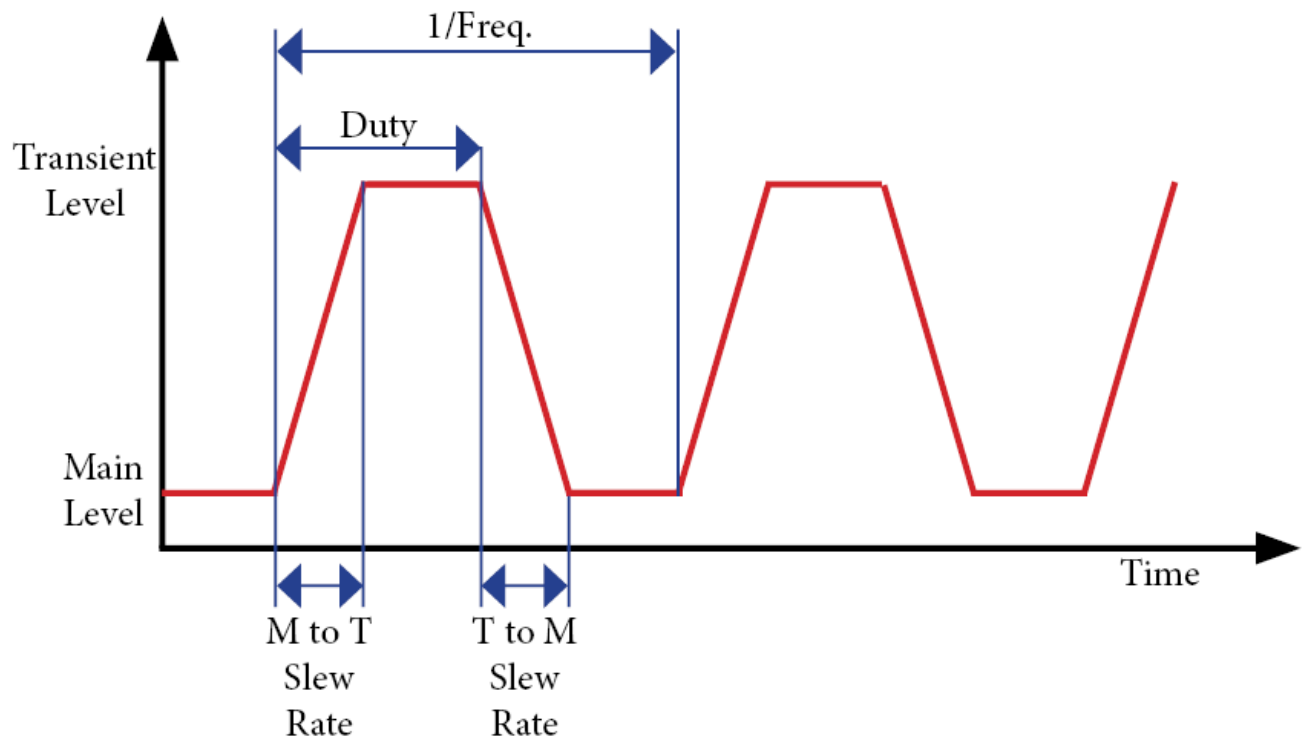

Figure 6.9 Continuous Transient Mode

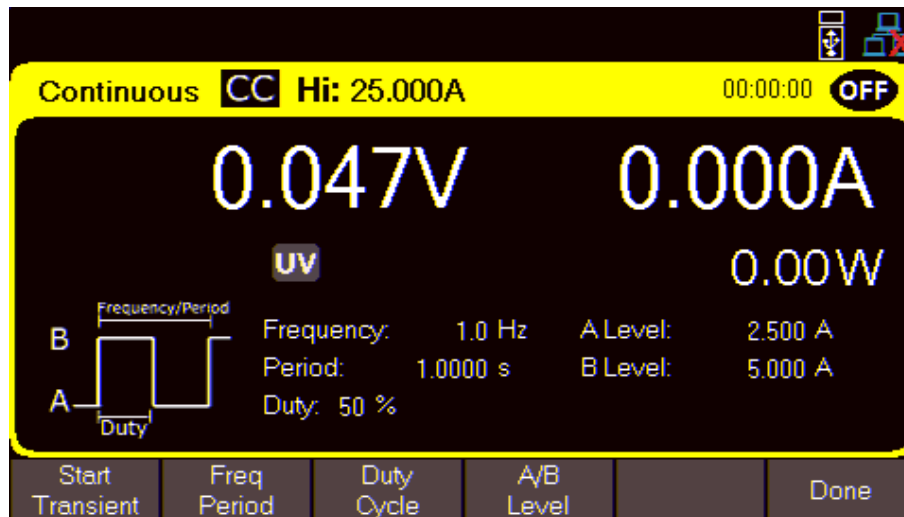

Figure 6.10 Continuous Transient Mode Menu

To start the **Continuous Transient Function** press the **F1 Softkey**.

NOTICE

Pressing the **Start Transient** softkey will not enable the load input. The input must be enabled manually.

Freq/Period

The period value represents the time it takes for a periodic waveform to complete one full cycle or repetition. The period is set in seconds and is inversely proportional to the frequency of the waveform.

A shorter period indicates a higher frequency and faster repetition of the waveform, while a longer period signifies a lower frequency and slower repetition.

Duty Cycle

Duty cycle value refers to the ratio of time that a periodic waveform spends in the "on" state compared to the total period of the waveform. It describes the proportion or percentage of time that a signal or pulse is active or high during each cycle.

The duty cycle is expressed as a percentage where a duty cycle of 50% means the signal is active for half of the period, and a duty cycle of 100% indicates that the signal remains active for the entire period. Conversely, a duty cycle of 0% means the signal is always inactive. The duty cycle can only be set between 01% and 99%.

A/B Level

The A/B Level refers to the two values the transient function will transition between. The values units will vary depending on the selected **Load Mode**.

6.2.1.2 Pulse Transient Mode

In pulse transient operation, the electronic load generates a pulse with user-defined amplitude and width when a trigger signal is received.

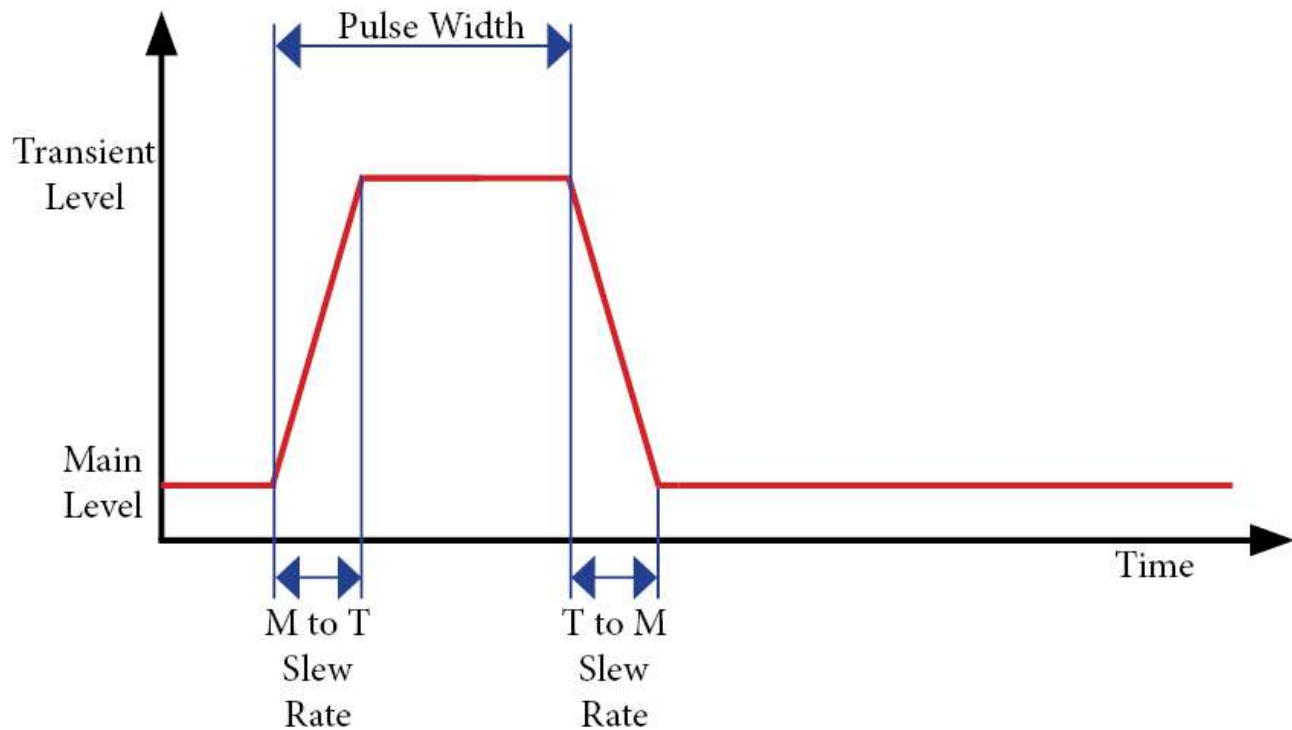

Figure 6.11 Pulse Transient Mode

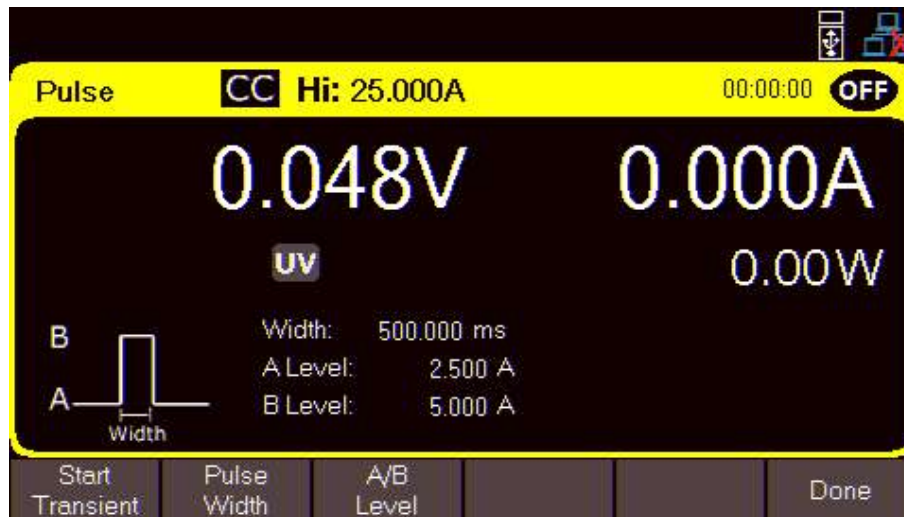

Figure 6.12 Pulse Transient Mode Menu

To start the **Pulse Transient Function** press the **F1 Softkey**.

NOTICE

Pressing the **Start Transient** softkey will not enable the load input. The input must be enabled manually.

Pulse Width

The pulse width value refers to the duration or length of time that a pulse remains on the specified level. Pulse width is measured is specified in ms.

A shorter pulse width corresponds to a narrower active portion of the waveform, resulting in a higher frequency and faster switching. Conversely, a longer pulse width indicates a wider active portion, resulting in a lower frequency and slower switching. By adjusting the pulse width, the duty cycle can precisely be manipulate to achieve the behavior and functionality of a transient system.

A/B Level

The A/B Level refers to the two values the transient function will transition between. The values units will vary depending on the selected **Load Mode**.

6.2.1.3 Toggle Transient Mode

In toggle transient operation the electronic load will switch between the main level and the transient level when a trigger signal is received.

The load will remain at the transient level until another trigger is received, at which time the load will switch back from the transient level to the main level.

Both of these switches in level occur in accordance with the user specified slew rate. **Figure 6.13** shows the current waveform in toggle transient operation.

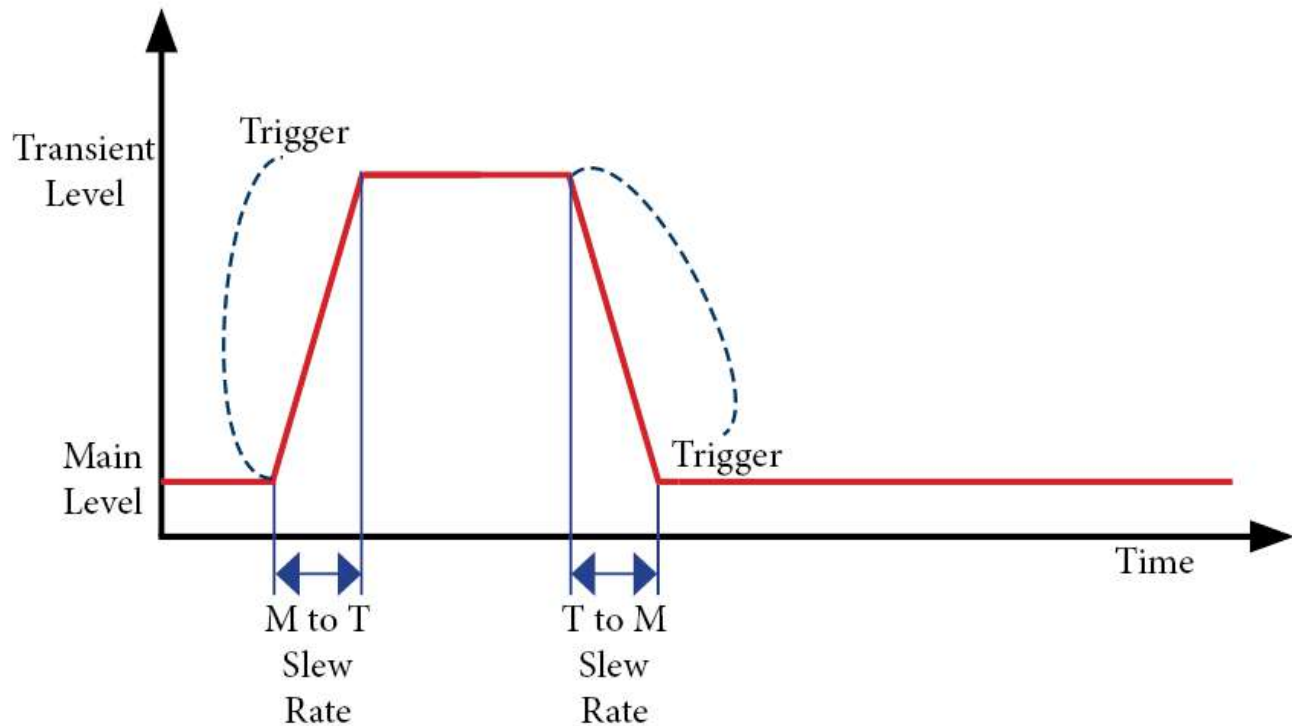

Figure 6.13 Toggle Transient Mode

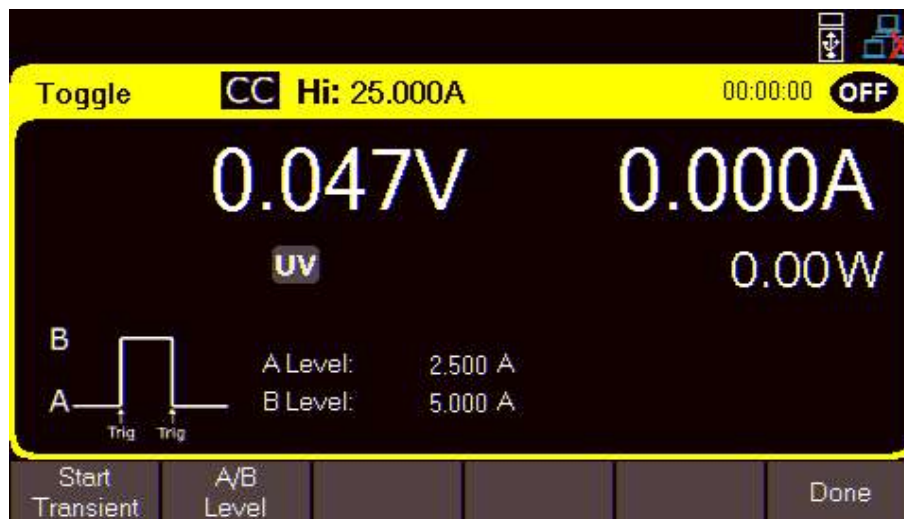

Figure 6.14 Toggle Transient Mode Menu

To start the **Toggle Transient Function** press the **F1 Softkey**.

NOTICE

Pressing the **Start Transient** softkey will not enable the load input. The input must be enabled manually.

A/B Level

The A/B Level refers to the two values the transient function will transition between. The values units will vary depending on the selected **Load Mode**.

6.3 List Mode

List mode allows users to generate complex sequences of input changes with rapid, precise timing, which may be synchronized with internal or external signals.

The HVL series is capable of storing up to 10 programmable lists in the internal memory. Each list can have up to 100 configurable steps.

If all ten list numbers are taken, a list can also be saved to a USB drive. Lists can be loaded from a USB drive, allowing for a larger collection of programmed lists.

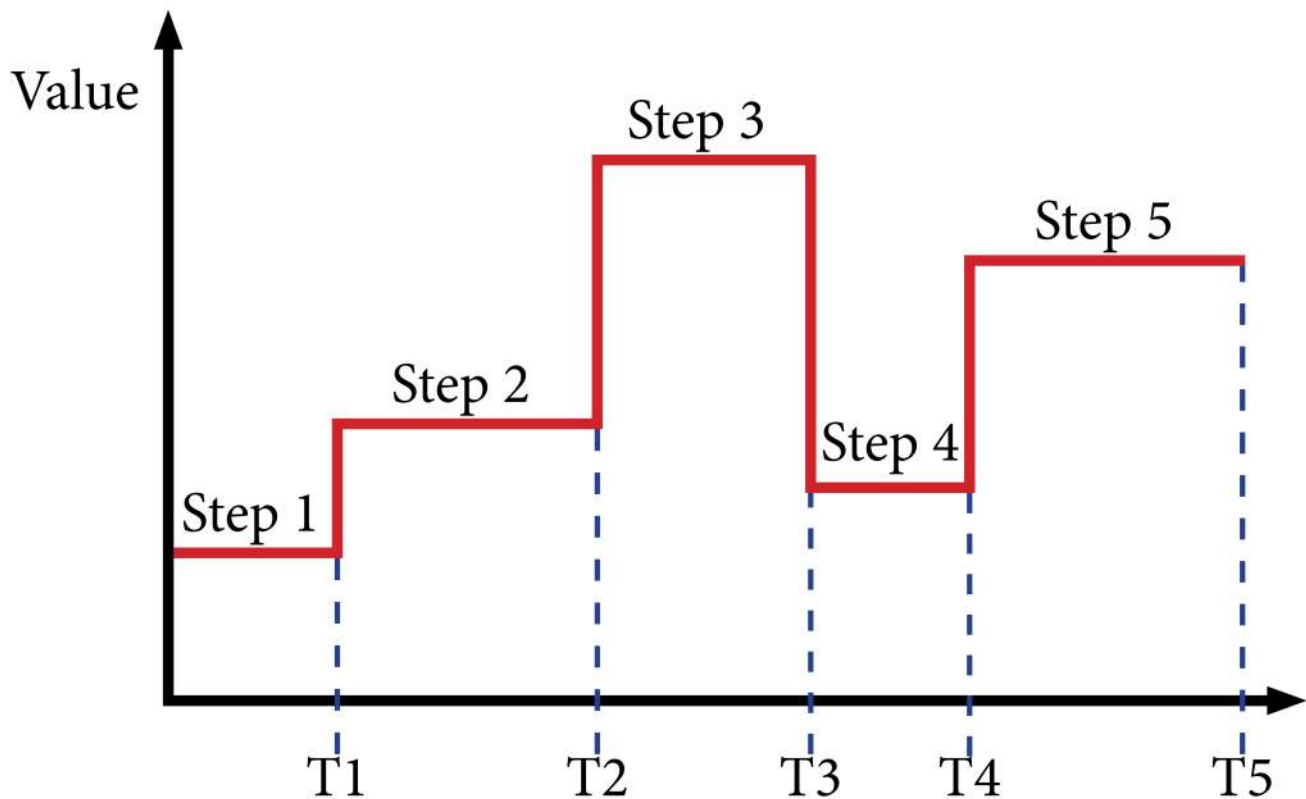

Figure 6.15 List Programmed Steps

6.3.1 List Setup

List mode consist of two portions **List Setup** and **List Configuration**.

To setup up list mode follow the steps below:

Step 1. Press **Utility > Input/Seq. Mode > List Setup > List Setup** to enter the **List Setup** menu.



Figure 6.16 List Setup Menu Page 1

Step 2. Press the **F1 softkey** to toggle the **List State** ON/OFF.

NOTICE

List State must be enabled in order to be able to execute the sequence from the home page. When enabled the function of the **F1 softkey** in the home page will change to **List Start** as shown in **figure 6.17**

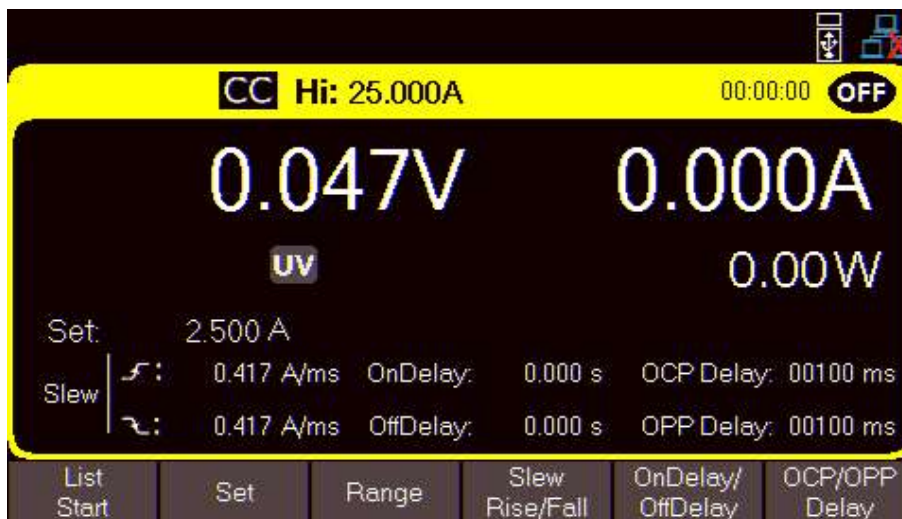

Figure 6.17 List Start

Step 3. Press the **F2 softkey** to set the **List Number** of the list to be executed or configured.

- The numeric keypad or the up and down navigation keys can be used to set the value.

Step 4. Press the **F3 softkey** toggle the **Pace** between Dwell and Trigger.

- Dwell:** The next step outputs once the dwell time elapsed
- Trigger:** After the dwell time elapsed, wait for a trigger before outputting the next step.

Step 5. Press the **F4 softkey** open the **Trigger Source** submenu.

- Manual:** Select to use a manual trigger. The **Trigger** softkey will be available once **List State** is on and exit out of the menu to the main display. Press it to manually trigger the list program. If the step dwell time has not elapsed, then **Trigger** will not have a white background. When dwell time elapses, **Trigger** background color will turn white to indicate the trigger is ready.

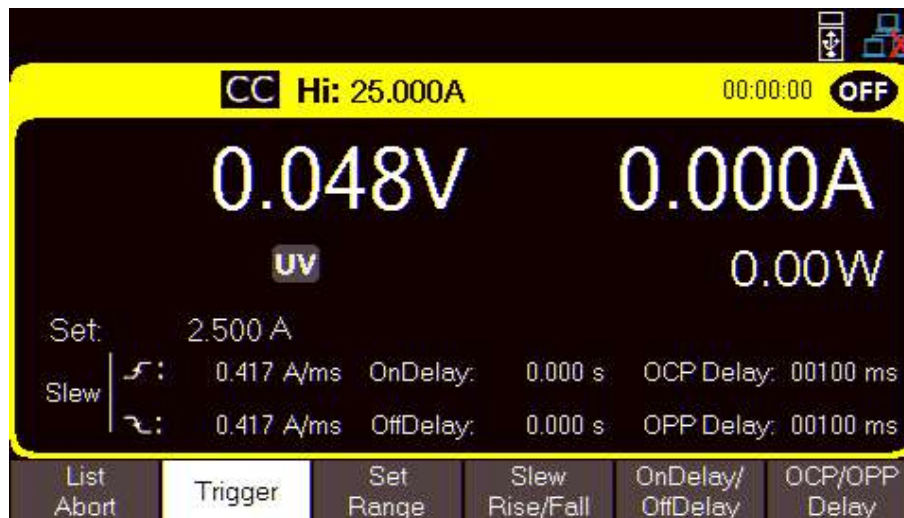

Figure 6.18 Waiting for Trigger

- Digital IO:** Select to use the digital I/O pins to receive a trigger. To assign trigger input function to a pin see [section 6.4.1](#).
- Remote:** Select to receive a trigger from the remote interface.

Step 6. Press the **F5 softkey** to view **Page 2** of the **List Setup** menu.



Figure 6.19 List Setup Menu Page 2

Step 7. Press the **F2 softkey** to set a **Trigger Delay**.

- Intentionally introduces a delay between the initiation of the trigger and the start of the following step.

Step 8. Press the **F3 softkey** to toggle **After List** between DC and Last.

- DC:** Returns to the last DC output voltage and current setting prior to enabling list mode.
- Last:** Retains the last step voltage and current setting after the list program ends.

NOTICE

If the list is aborted, the output will return to the last set value before the list began, even if After List is set to Last.

6.3.2 Edit List

To edit a list follow the steps below:

Step 1. Press **Utility > Input/Seq. Mode > List Setup > Edit List** to enter the **Edit List** menu.



Figure 6.20 Edit List Menu Page 1

Step 2. Press the **F2 softkey** to set the **List Number** of the list to be configured.

- The numeric keypad or the up and down navigation keys can be used to set the value.

Step 3. Press the **F3 softkey** to set the operation **Mode** for the selected list.

Step 4. Press the **F4 softkey** to set the **Next** list program to run once the current list elapse.

- To make a list run continuously and indefinitely, set **Next** to the same number as **List Number**.
- To run different list sequences continuously, set **Next** to each other.

Example

Set **Next** on List 1 to 2.

Set **Next** on List 2 to 1.

Step 5. Press the **F5 softkey** to view **Page 2** of the **Edit List** menu.

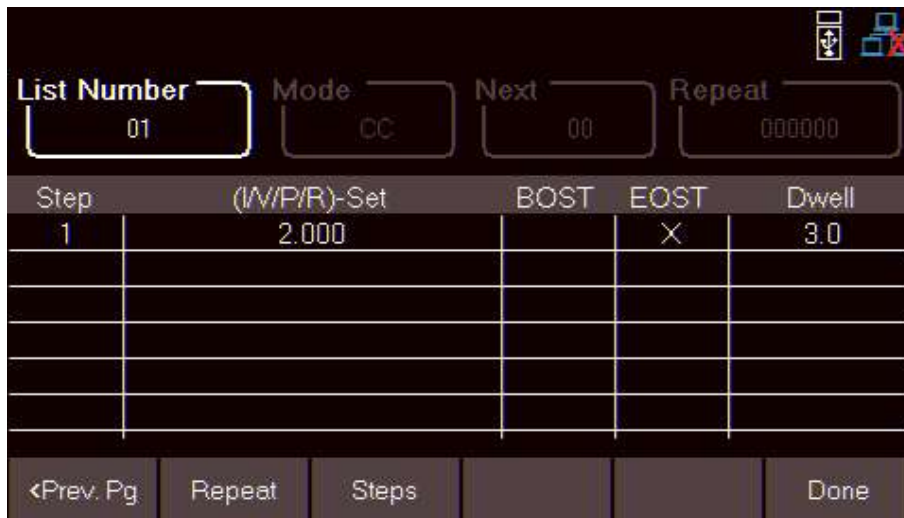

Figure 6.21 Edit List Menu Page 2

Step 6. Press the **F2 softkey** to set the **Repeat** count. The repeat count determines how many times the list will be executed before elapsing or moving on to the selected **Next** list.

Step 7. Press the **F3 softkey** to enter the **Step** menu.

- In the **Step** menu the steps and its parameters can be configured.

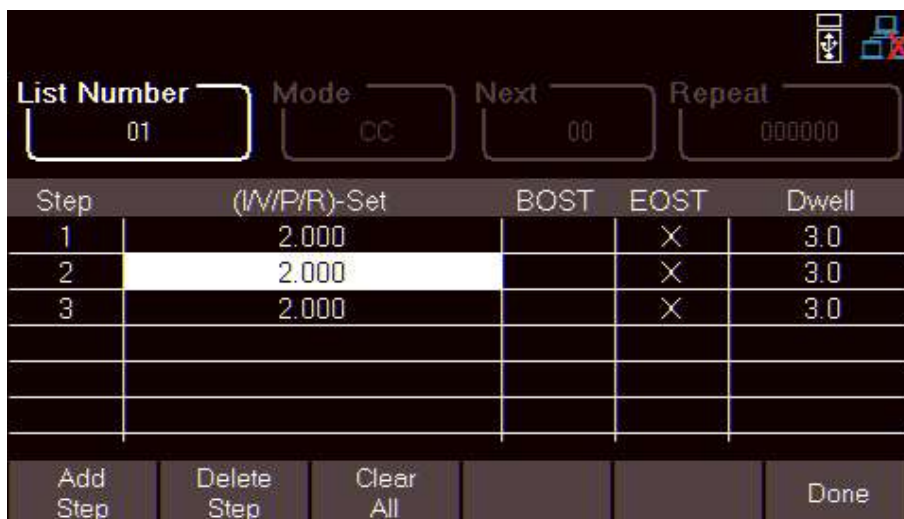

Figure 6.22 Edit List Step

- **Add Step:** Adds a step to the list. The step added will be a duplication of the step selected before pressing Add Step. To select a step to duplicate, use the navigation keys to navigate the available steps. If the list is new, only one default step will be available. Pressing Add Step will duplicate the default step.
- **Delete Step:** Deletes the selected step.

- **Clear All:** Clears all current steps.

Step 8. Use the navigation keys to navigate the available steps.(select a row)

Step Parameters	Description
(I/V/W/R)- Set	Set the level value for the selected mode.
BOST	Press the Enter button to enable/disable a trigger-out signal at the beginning of the step (BOST).
EOST	Press the Enter button to enable/disable a trigger-out signal at the end of the step (EOST).
Dwell	Sets the dwell time of the selected step.

Table 6.1 Step Parameters

6.4 Analog Digital I/O Connector

The analog digital input/output port provides a hardware connection for input voltage and current monitoring, external analog control, external trigger, digital output, fault output, remote on/off input and a relay connection.

The pinout of the **Analog Digital I/O Connector** can be seen in **figure 6.23**. For more details on the function of each pin refer to **tables 6.2** and **6.3**

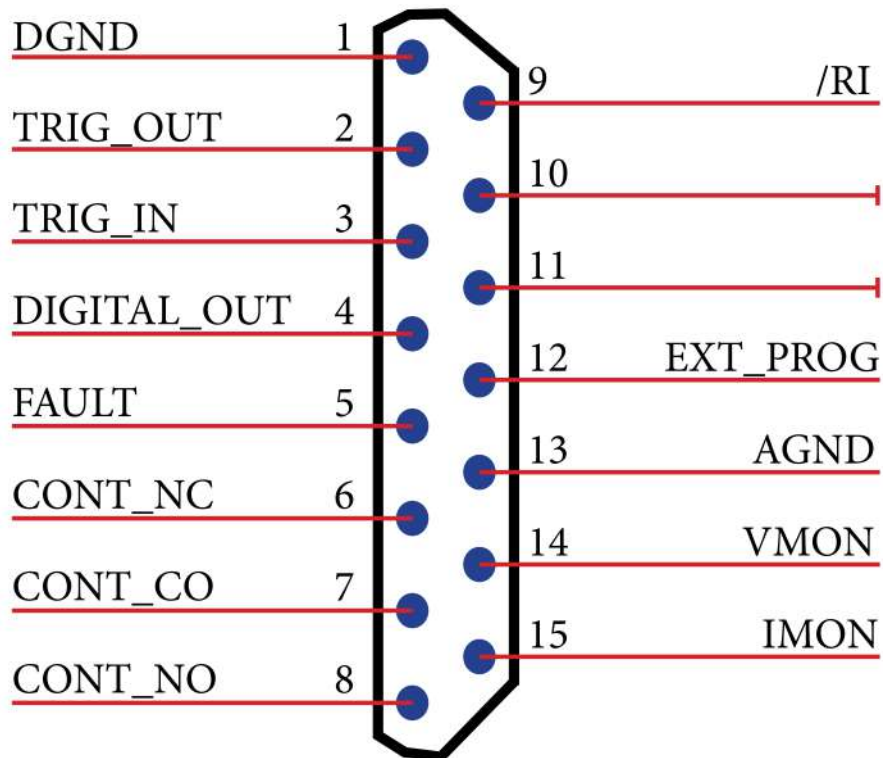

Figure 6.23 Analog Digital Input/Output

Pin	Signal Name	Description
1	DGND	Digital ground - Provides the common or reference connection for digital signals such as TRIG_OUT, TRIG_IN, PORT_OUT, FAULT and RI.
2	TRIG_OUT	External trigger signal output - A TTL compatible signal that is activated when the trigger signals from the trigger source setting is activated. The trigger source set can EXTERNAL, HOLD or BUS triggering.
3	TRIG_IN	External trigger signal input - A TTL compatible negative edge triggered signal that is used to trigger the event in transient operation. To enable this external TRIG_IN, the trigger source must be set to external.
4	DIGITAL_OUT	Digital port output - A TTL compatible output port active by front panel ops or by remote SCPI command.
5	FAULT	False signal out - A TTL compatible signal will be activated (goes to high) if alarm, hardware fail or internal fault is triggered.
6	CONT_NO	Contact relay normally open - An internal dry contact relay to provide isolate contact for external controller or external alarm panel. When fault condition occurs, the CONT_NO and CONT_CO will close (connected).
7	CONT_CO	Contact relay common - Provides the common or reference connection for relay contacts of CONT_NO and CONT_NC.
8	CONT_NC	Contact relay normally closed - An internal dry contact relay is used to provide isolated contact for external controller or external alarm panel. When fault condition occurs, the CONT_NC and CONT_CO will open (disconnected).

Table 6.2 Analog Digital IO Connector 1/2

Pin	Signal Name	Description
9	RI	Remote inhibit signal input - A TTL compatible negative activated input signal is used as an emergency switch to disable the electronic load input. RI can be connected to an external switch reference to DGND. If the switch is closed, the RI is activated and the input will turn off.
10	NC	No connection
11	NC	No connection
12	EXT_PROG	Ext analog programming signal input - This is an external analog input from 0V to 10V that represents zero to full scale of the range of programming level.
13	AGND	Analog ground - the common or reference connection for analog signals such as EXT_PROG, VMON and IMON.
14	VMON	Input voltage monitoring signal - Outputs a zero to 10V signal that is linearly proportional to the input voltage from zero to full scale of high range.
15	IMON	Input current monitoring signal - Outputs a 0 to 10V signal that is linearly proportional to the input current from zero to full scale of high range.

Table 6.3 Analog Digital IO Connector 2/2

Dry Contact Relay

The internal dry contact relay serves as a valuable mechanism for safely interlocking the electronic load with an external disconnection device, such as a contactor. This is particularly important when testing the electronic load with an unprotected power source like a battery. It is highly advisable to install a DC contactor in conjunction with the electronic load and battery in series. In the event of a fault or alarm condition, the dry contact relay can be utilized to turn off and disconnect the DC contactor, preventing potential hazards like large currents and fire.

It is strongly recommended to install a DC contactor in series with the electronic load and battery. In case of any fault or alarm condition, the dry contact relay can be served to turn off and disconnect the DC contactor to prevent a large current which may cause fire hazard.

6.4.1 Digital Output Control

A TTL compatible DIGITAL_OUT digital output pin can be configured by the user or by the input state of the electronic load. This pin is located at the pin 4 of the Analog DIO connector.

To configure the **Digital Output**:

Step 1. Press **Utility button** > **Utility softkey** > **I/O Config** > **Digital I/O** to enter the **Digital I/O** menu.



Figure 6.24 Digital I/O

Step 2. Press the **F1 softkey** to expand the **Digital Out Control** settings.

- **Table 6.4** shows the available controls.

Control Setting	Description
FORCE LOW	DIGITAL_OUT is permanently low.
FORCE HIGH	DIGITAL_OUT is permanently high.
LOW @ ON	DIGITAL_OUT is low when input is on.
HIGH @ ON	DIGITAL_OUT is high when input is on.

Table 6.4 Digital Out Control

Step 3. Press the **F2 softkey** and use the numeric keypad to configure the **Digital Out Delay**.

Step 4. Press the **F3 softkey** to expand the **Remote Inhibit** settings.

- **Table 6.5** shows the available controls.

Remote Setting	Description
DISABLE	The remote inhibit is disabled
LIVE	The RI input acts as an input on/off control signal. If the RI is low or short from DGND, the input turns off. If the RI is high or open from DGND, the input turns on.
LATCH	The RI input acts as a negative triggered signal. The input turns off when RI goes from high to low. The user will have to turn on the input by either front panel operation or SCPI remote command.

Table 6.5 Remote Inhibit

6.4.2 Analog State

To enable **Analog State** press **Utility > Input/Seq. Mode > Analog Control > Analog State**.

The analog 0 to 10 volts external programming signal is equivalent of zero to full scale of the high or low range in CC, CV, CP or CP modes.

Table 6.6 shows an example of external programming signal level vs. main value of a HVL100050. For a setup example refer to **figure 6.26**

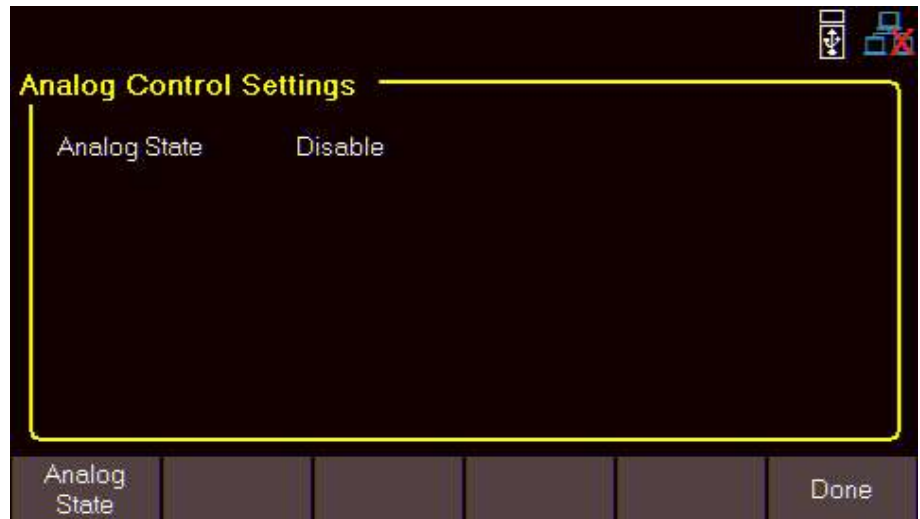

Figure 6.25 Analog Control Settings

EXT_PROG Voltage	Mode-Range	Full Scale Value	Main Value
0 V	CCH	50 A	0 A
5 V	CCH	50 A	25 A
10 V	CCH	50 A	50 A
0 V	CCL	5 A	0 A
5 V	CCL	5 A	2.5 A
10 V	CCL	5 A	5 A
5 V	CVH	1000 V	500 V
5 V	CVL	100 V	50 V

Table 6.6 External Control for HVL100050

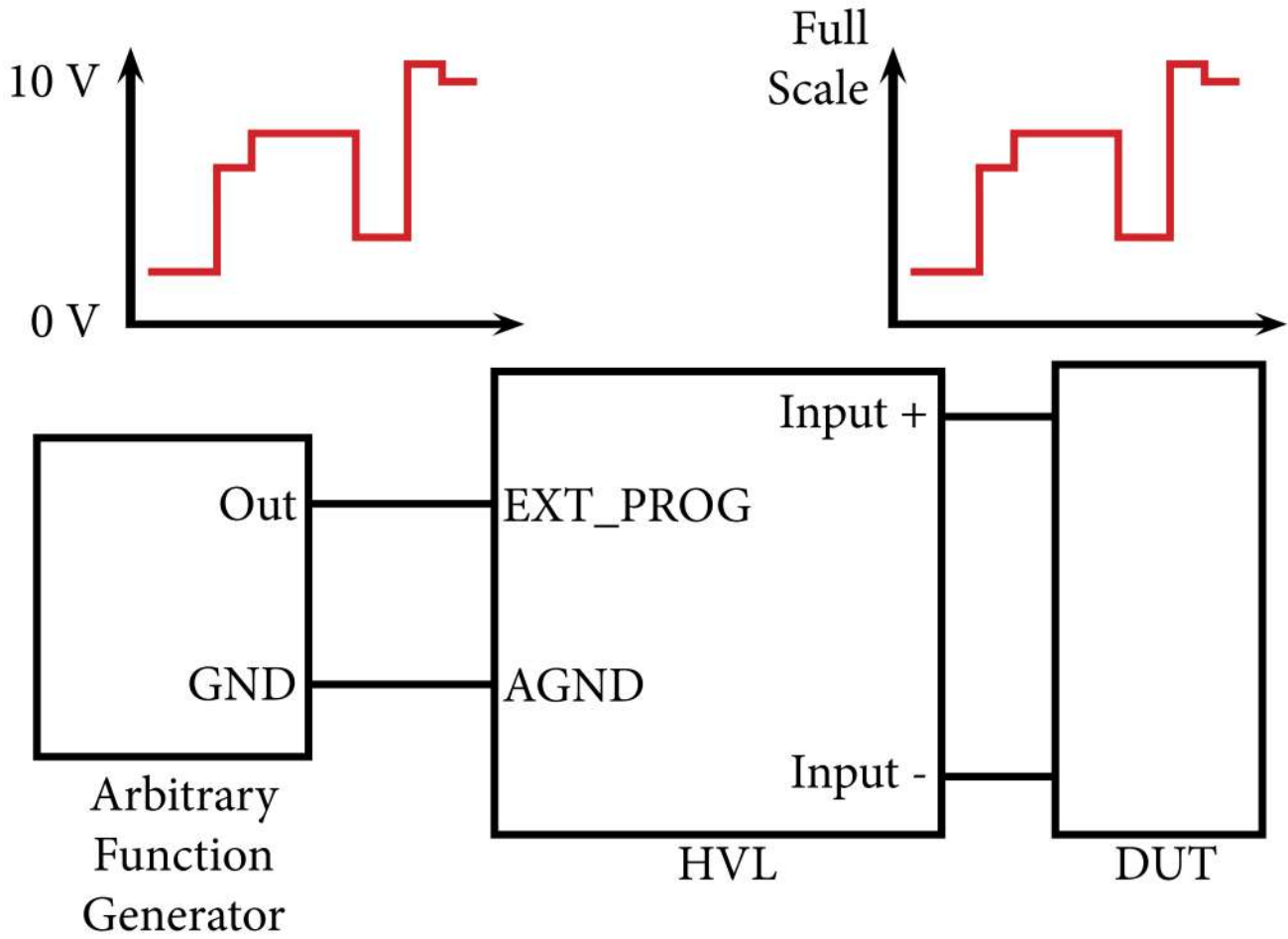

Figure 6.26 External Control Setup

6.5 Parallel Mode

For the applications that require a large electronic load, the HVL series is capable of being connected in parallel with up to 10 units of the same voltage rating model. The electronic load can be set to master or slave unit in the parallel operation.

For one group of parallel operated electronic loads, set only one unit as the master unit and rest of the units as the slave unit. To connect multiple electronic loads in this operation, use the standard DB9 male to female cable and connect from Para-OUT connector of the master unit to Para-IN connector of the slave unit.

If multiple slave units are desired, use more DB9 male to female cables to cascade the Para-OUT connector of the slave unit to the Para-IN connector of the next slave unit. **Figure 6.32** shows the back panel connection in parallel operation.

To setup the master/slave configurations:

Step 1. Press **Utility > Input/Config > List Setup > Parallel Settings** to enter the **Parallel Settings** menu.



Figure 6.27 Parallel Settings

Step 2. Press the **F2 softkey** to set the instrument's **Master/Slave** state.

- Use the Up/Down navigation keys to toggle between the available modes. (off, Master, Slave1.....,Slave10)

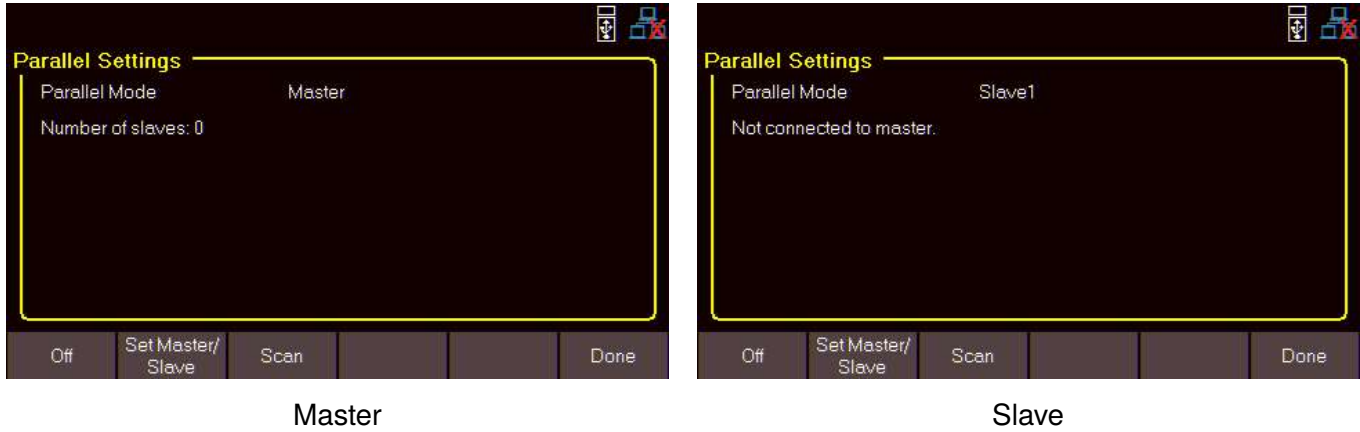

Figure 6.28 Master/Slave

Step 3. Press the **F3 softkey** to **Scan** for a master or slave units.

- The instrument will indicated it is scanning as shown in **figure 6.29**.



Figure 6.29 Scanning

- Once the scan is complete the master will display the number of slaves that were found.
- If a master was found the slaves will display it is connected to the master.

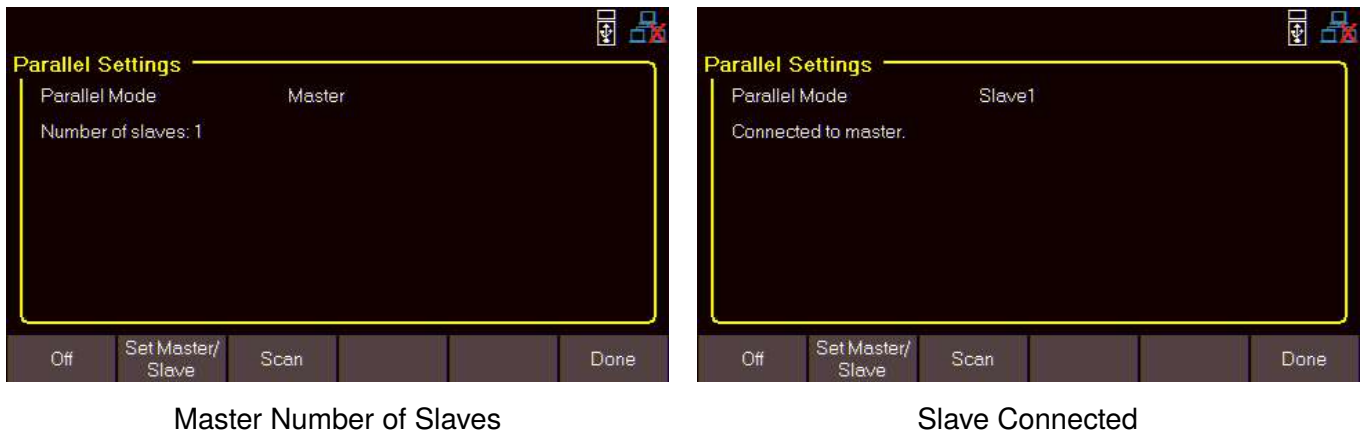

Master Number of Slaves

Slave Connected

Figure 6.30 Scan Complete

Step 4. Pressing the **F1 softkey** will turn parallel mode **Off**.

- The instrument will first notify the user the mode is being disabled.
- Once disabled the "Success" message will be displayed

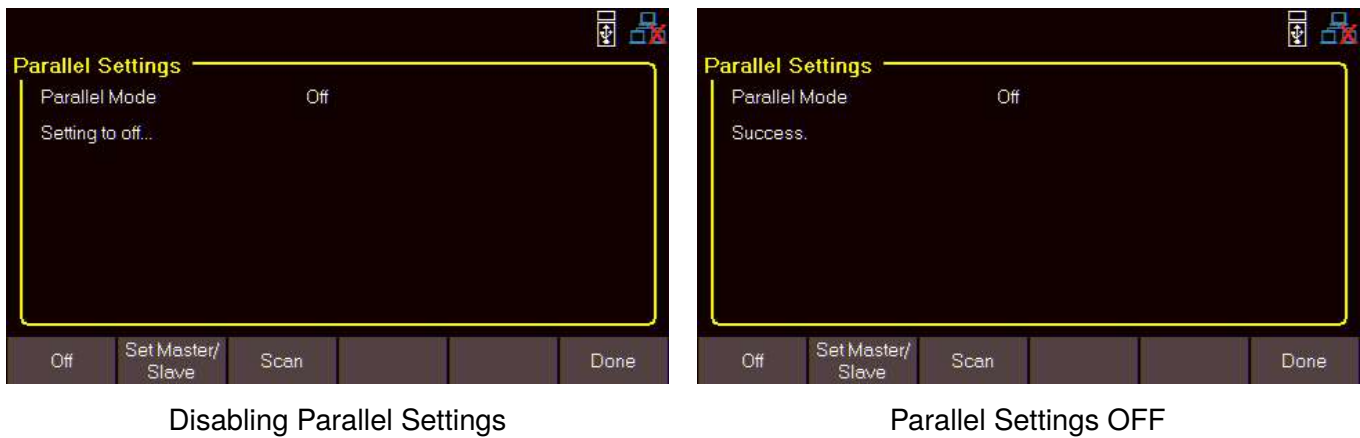

Disabling Parallel Settings

Parallel Settings OFF

Figure 6.31 Disable Parallel Mode

NOTICE

During parallel operation, set the desired value in CC, CV, CP or CR mode of the master unit, the slave units will share the proportional current with the master unit.

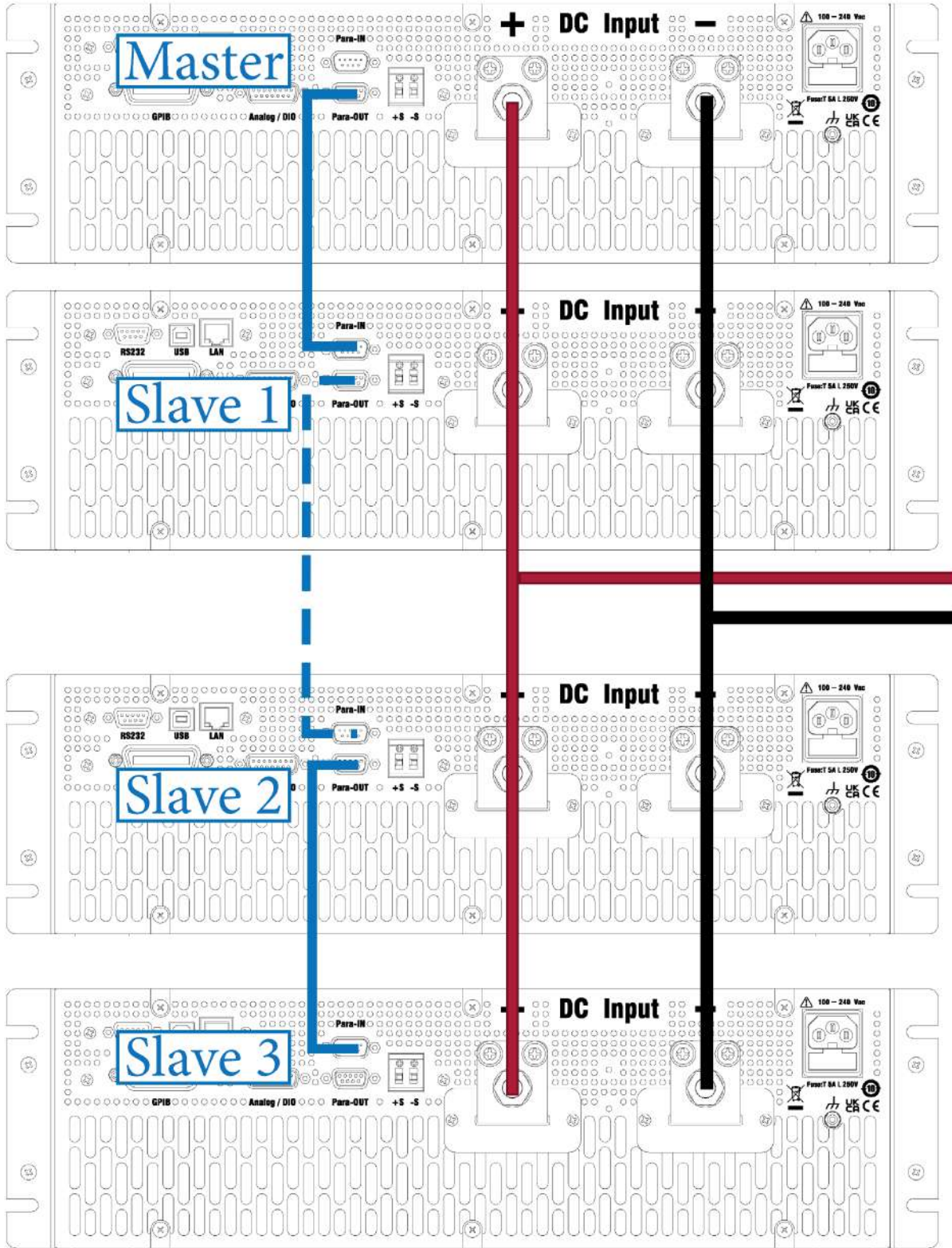

Figure 6.32 Parallel Operation Diagram

6.6 Rise/Fall Measurement Settings

The rise and fall measurement function measures and analyzes the response time and characteristics of the load when subjected to changes in voltage or current levels. This function allows users to evaluate the load's performance in terms of how quickly and smoothly it can transition between different input levels.

To configure the Rise/Fall Measurement settings:

Step 1. Press **Utility > Input/Seq. Mode** to enter the **Rise/Fall Measurement Settings** menu.

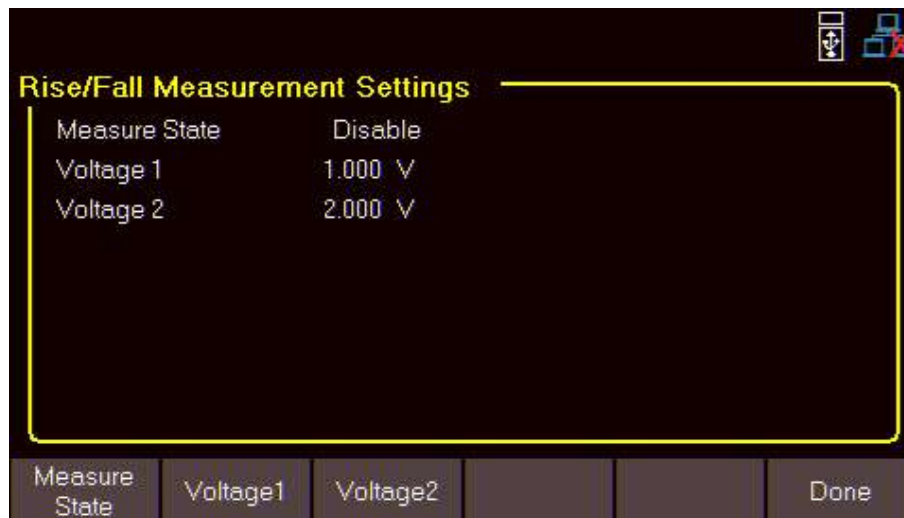

Figure 6.33 Rise/Fall Measurement Settings

Step 2. Press the **softkey** corresponding to the desired parameter.

Step 3. Use the numeric keypad to enter desired voltage levels.

- For the **State** parameter, pressing the softkey will toggle the state between **Enable** and **Disable**.

Input Configuration

The Input Configuration settings of a DC load refer to the various parameters and options that can be adjusted to control the behavior and characteristics of the load. These settings enable users to tailor the load's performance to suit specific testing or operational requirements.

7.1	Over Protection	70
7.1.1	Overvoltage Protection (OVP)	70
7.1.2	Overcurrent Protection (OCP)	70
7.1.3	Overpower Protection (OPP)	70
7.2	Input Settings	72
7.2.1	Remote Sense	72
7.2.2	Timer State and Setting	72
7.2.3	Slew Rise/Slew Fall (A/ms)	73
7.2.4	On/Off Delay	73
7.2.5	Loop Response and CR Control	74
7.2.6	Oscillation Protection	74
7.2.7	Averaging	75
7.2.8	Soft Start	75

7.1 Over Protection

The over protection settings are configurable parameters and safeguards designed to prevent damage to the load itself or the connected power source in the event of excessive voltage, current, or power levels. These settings play a critical role in ensuring the safe and reliable operation of the load and the equipment under test.

In order to protect both the load and the connected devices, the HVL series is equipped with various over protection settings, which include:

7.1.1 Overvoltage Protection (OVP)

This setting establishes a maximum voltage threshold beyond which the load automatically shuts down to prevent excessive voltage from reaching the load. OVP safeguards against voltage spikes or regulator failures that could otherwise damage the load or connected equipment.

7.1.2 Overcurrent Protection (OCP)

OCP limits the maximum current that can flow through the load. When the current exceeds the set threshold, the load shuts down to prevent damage to the load or the power source. OCP is crucial for preventing excessive current that could lead to overheating, component failure, or unsafe conditions.

7.1.3 Overpower Protection (OPP)

OPP limits the power dissipation within the load. By defining a maximum power threshold, the load can react to situations where the power exceeds the allowed limit, ensuring the load and the connected devices operate within safe operating conditions.



Input shut down can be delayed up to 10000 ms. Delay the protection settings can cause damage to the DUT and in some cases the load.



The state of the Over Protection settings can be disabled. When disabled the shut down protection will not be triggered even when the threshold value is exceeded.



The HVL series provides a static **Temperature Protection**, which shuts down the instrument altogether, to prevent overheating and potential damage.

To configure the protection settings:

Step 1. Press **Utility > Input/Config > Protection Settings** to enter the **Over Protection Settings** menu.

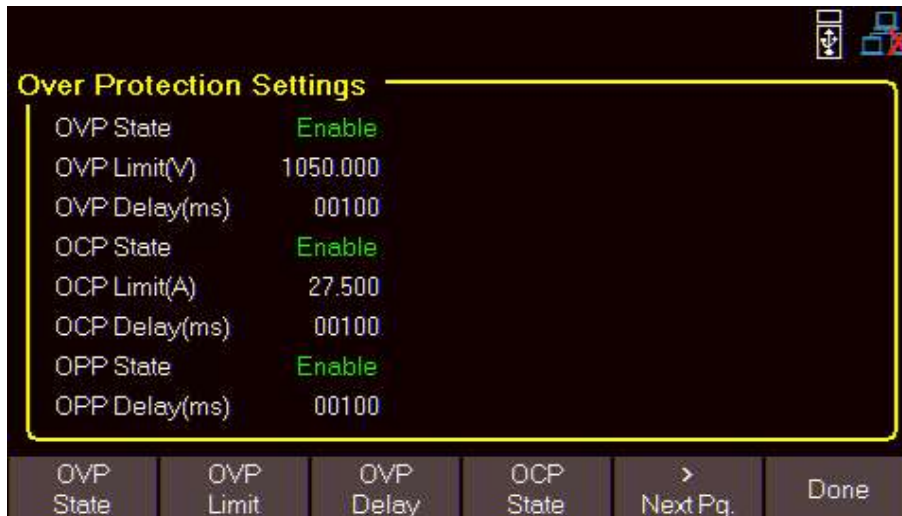

Figure 7.1 Over Protection Settings Menu

Step 2. Press the **softkey** corresponding to the desired parameter.

Step 3. Use the numeric keypad to enter desired threshold.

- For **State** parameters, pressing the softkey will toggle the state between **Enable** and **Disable**.

7.2 Input Settings

The input settings of a DC load encompass the adjustable parameters that determine how the load's input interacts. These settings allow users to customize and control the behavior of the input, facilitating precise testing.

The HVL series is equipped with the following input settings:

7.2.1 Remote Sense

Remote sense enables accurate voltage regulation at the load's terminals, compensating for voltage drops along the connecting cables. It allows the load to sense and regulate the voltage directly at the (DUT), providing more precise and reliable measurements.

The remote sense function is particularly valuable when testing sensitive or high-precision devices that require accurate voltage regulation.

The remote sense function involves the use of additional sense wires that are connected to the load and attached near the terminals of the DUT. These sense wires monitor the voltage directly at the DUT, compensating for any voltage drop that may occur across the connecting cables due to their resistance.

By comparing the sensed voltage at the DUT terminals with the desired voltage set by the load, the remote sense function allows the load to adjust its output voltage accordingly, compensating for voltage loss up to 1 V, and ensuring that the DUT receives the desired voltage level. This feature becomes particularly crucial when the DUT is located far away from the load or when using long and resistive cables that can introduce significant voltage drops.

7.2.2 Timer State and Setting

The timer setting allows users to define a specific duration or time limit for the load operation. This feature enables automated control over the load's on/off cycles, providing convenient timing capabilities for testing and operational purposes.

With the timer setting, users can specify the duration of the load operation in terms of hours, minutes, and seconds. Once the set time limit is reached, the load can automatically turn off, completing the desired testing cycle. This feature is particularly useful when conducting endurance tests, evaluating battery life, or performing time-based evaluations.

7.2.3 Slew Rise/Slew Fall (A/ms)

The slew rate determines the rate at which the load can change its output voltage or current levels. These parameters control the load's ability to mimic rapid changes in the power source and simulate dynamic load conditions accurately.

The slew rate is expressed in A/ms), indicating the rate of change over time. A higher slew rate value means that the load can respond more rapidly to input signal changes.

By configuring the slew rate parameters, users can accurately replicate scenarios where the load experiences sudden changes in voltage or current, such as voltage spikes or transients. This is particularly important when testing the performance of power supplies, batteries, or electronic components that need to withstand or respond to fast load variations.

FAST and Normal Loop Response	CC Low Range (A/ms)	CC High Range (A/ms)	CV Low Range (V/ms)	CV High Range (V/ms)	CW Low Range (A/ms)	CW High Range (A/ms)	CR Low Range (V/ms)	CR High Range (A/ms)
HVL600150	0.05-3000	0.05-3000	0.2-1200	0.2-1200	0.05-300	0.05-300	1000	0.05-300
HVL600300	0.1-6000	0.1-6000	0.2-1200	0.2-1200	0.1-600	0.1-600	1000	0.1-600
HVL80075	0.025-1500	0.025-1500	0.267-1600	0.267-1600	0.025-150	0.025-150	1000	0.025-150
HVL800150	0.05-3000	0.05-3000	0.267-1600	0.267-1600	0.05-300	0.05-300	1000	0.05-300
HVL100025	0.008~500	0.008~500	0.333-2000	0.333-2000	0.008-50	0.008-50	1000	0.008-50
HVL100050	0.017-1000	0.017-1000	0.333-2000	0.333-2000	0.017-100	0.017-100	1000	0.017-100

7.2.4 On/Off Delay

The On/Off Delay parameters determines the time delay between the activation/deactivation command and the actual start/end of load operation. These parameters allow users to introduce a controlled delay before the load begins applying its simulated load characteristics to the power source being tested.

By configuring the On/Off Delay parameters, users can introduce a time delay to simulate real-world scenarios where devices may take some time to stabilize or reach their operating state. This delay can be used to account for warm-up periods, initialization processes, or other time-dependent factors that affect the load's behavior.

7.2.5 Loop Response and CR Control

The Loop Response setting determines how quickly the load can respond to changes in the input conditions, such as voltage or current. It characterizes the load's dynamic behavior and its ability to track rapid variations in the power source.

By adjusting the Loop Response setting, users can control the load's ability to follow changes in the input signal. A fast loop response setting enables the load to respond quickly to sudden variations in voltage or current, simulating dynamic load conditions accurately. This is particularly important when evaluating the performance of power supplies under transient load scenarios or testing the stability and response time of control systems.

Conversely, a slower loop response setting may be preferred in certain applications where a slower load response is desired, such as testing the behavior of power sources in steady-state or low-dynamic conditions.

The Loop Response setting is expressed in four speeds: Fast, Normal, Slow, and Slowest, Where Fast loop response offers the best tracking capabilities.

The CR Control setting determines the tracking method for loop control. It is expressed as either Fine-Tune or Free-Run, where Fine-Tune sets a constant CR value for the duration of the operation, and Free-Run continuously adjust the internal DAC from feedback of the measured V and I. Free-Run allows for more accurate CR values.

7.2.6 Oscillation Protection

The loop response setting has a direct effect on the slew rate between load changes, therefore it is important to select the setting that best fits the application. Ideally, the FAST speed setting will provide the fastest transition between load changes, however oscillations may occur. These oscillations are usually caused by parasitic inductance in the wires connected between the load and the DUT. In general, the longer the wires, the higher the parasitic inductance. This in turn causes oscillation to the load, which is reflected when the load input becomes unstable or unregulated. On the contrary, when the SLOW or SLOWEST speed setting is selected, long wires will less likely cause any load oscillation. However, the slew rate will also be slower between load transitions. Therefore, it is recommended to set Loop Response to NORMAL speed, and only adjust based on the requirements of the application

7.2.7 Averaging

The averaging parameters determines how the load calculates and presents averaged measurements of voltage, current, or power. This parameter allow users to smooth out fluctuations and obtain more stable and representative readings during testing and evaluation processes.

By configuring the averaging parameters, users can set the sample count used to calculate the average values.

The averaging parameters help mitigate the effects of transient variations or noise in the measured signals. By averaging the values over a specific sample size, the load provides a more stable and representative measurement, reducing the impact of short-term fluctuations and providing a clearer picture of the overall performance of the power source.

Users can adjust the averaging parameters to strike a balance between responsiveness and stability. A smaller sample size offer more real-time measurements but may be susceptible to noise and rapid variations, while a larger sample size provide smoother and more stable measurements at the cost of reduced responsiveness to immediate changes.

7.2.8 Soft Start

The Soft Start function ramps up the load's output voltage or current when it is initially turned on. This function is designed to prevent sudden voltage or current surges that could potentially damage the load or the device under test (DUT), ensuring a controlled and safe startup process.

When the Soft Start function is activated, the load initially operates at a lower input voltage or current level, gradually increasing it over a specific time period. This gradual increase helps prevent sudden voltage or current spikes that could stress or damage the DUT, particularly when dealing with sensitive or fragile devices.

The Soft Start function is particularly useful in situations where the load is connected to power sources or DUTs that are susceptible to voltage or current transients during startup. By gradually ramping up the input parameters, it provides a controlled and safe transition, reducing the risk of damage and ensuring the integrity of the testing process.

To configure the input settings:

Step 1. Press **Utility > Input/Config > Input Settings** to enter the **Input Settings** menu.



Figure 7.2 Input Settings Menu

Step 2. Press the **softkey** corresponding to the desired parameter.

Step 3. Use the numeric keypad to enter desired threshold.

- For **State** parameters, pressing the softkey will toggle the state between **Enable** and **Disable**.

Data Logger

The data logging function allows the load to record and store various measurements and parameters during testing or operation to an external flash drive. This function enables users to capture and analyze data over time, facilitating detailed analysis, troubleshooting, and performance evaluation of the power source being tested.

With the data logging function, users can specify the parameters to be logged, such as voltage, current, or power. The load continuously monitors and records these parameters at regular intervals up to 200ms, creating a comprehensive data log of the load's behavior and the performance of the power source.

The logged data can be saved to a .csv file which can then be exported and analyzed using external software tools.

8.1 Configuring the Data Logger 77

8.1 Configuring the Data Logger

To configure and enable the data logger follow the instructions below:

Step 1. Press **Utility button** > **Data Log** to enter the **Data Logger Settings** menu.

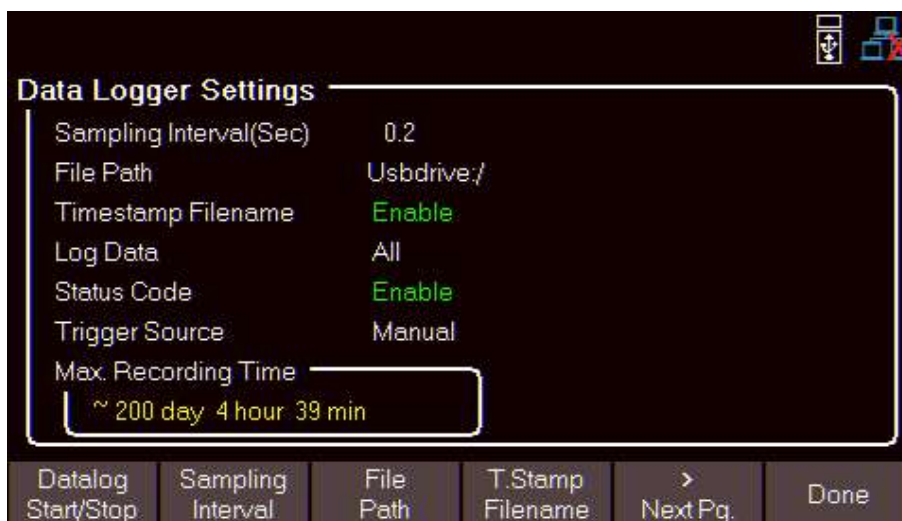

Figure 8.1 Data Logger Settings Menu 1/2

Step 2. Press the **F2 softkey** to set the **Sampling Interval**.

- Use the numeric keypad to enter the sampling interval (200 ms to 300 s).

Step 3. Press the **F3 softkey** to set the **File Path** where the file will be stored.

- Use the navigation keys to navigate to the directory where the file will be saved.
- Once in the desired directory press the **F1 softkey** to confirm the file path.

Step 4. Press the **F4 softkey** to toggle the **T. Stamp Filename**.

- When enabled the time and date will be appended to the file name.
- **Figure 8.2** shows both file names with T.Stamp Filename enabled and disabled.

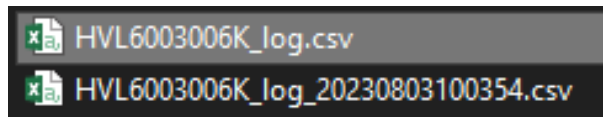

Figure 8.2 T. Stamp
Filename Enabled/Disabled

Step 5. Press the **F5 softkey** to view the remaining data logger parameters.

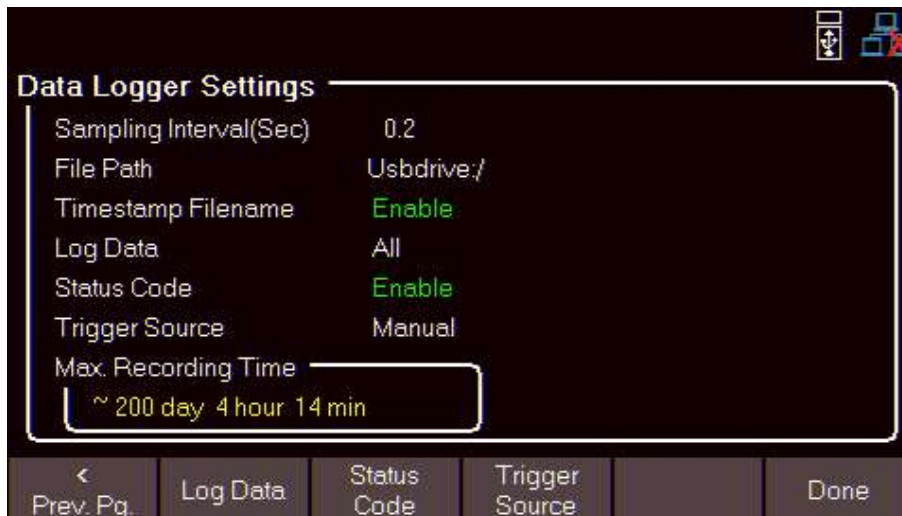

Figure 8.3 Data Logger Settings Menu 2/2

Step 6. Press the **F2 softkey** to view the available **Log Data**.

- The logger can be configured to log all parameters, only voltage, or only current.
- **Figure 8.4** demonstrates an example where **Log Data** is set to All.

HVL6003006K 000000000 Datalog			
Sample interval: 0.2			
Log data:All			
Date: 2023-06-29 23:07:39			
00:00:00.00	0	0	0x0000 0x0000
00:00:00.20	0	0	0x0000 0x0000
00:00:00.40	0	0	0x0000 0x0000
00:00:00.60	0	0	0x0000 0x0000
00:00:00.80	0	0	0x0000 0x0000
00:00:01.00	0	0	0x0000 0x0000
00:00:01.20	0	0	0x0000 0x0000
00:00:01.40	0	0	0x0000 0x0000
00:00:01.60	0	0	0x0000 0x0000

Status Code 1

Status Code 2

Figure 8.4 Data Log set to All

The data is recorded in the following order:			
Elapsed Time	Voltage	Current	Status Code

Table 8.1 Data Order

NOTICE

Data Order will vary depending on the set **Log Data**.

Step 7. Press the **F3 softkey** to toggle the **Status Code** recording state.

- Enabled **Status Code** will record all codes reported.

NOTICE

The **Status Code** column contains two separate codes as shown **figure 8.4**. The status code is shown in 2 byte hexadecimal and is determined by the bit state of the registers shown in **tables 8.2** and **8.3**.

Bit15	Bit14	Bit13	Bit12	Bit11	Bit10	Bit9	Bit8	Bit7	Bit6	Bit5	Bit4	Bit3	Bit2	Bit1	Bit0
LV	OSC	PS	UVP	OVP	UNR	RI	—	RSF	RCP	OTP	—	OPP	OTS	OCP	OTW

Table 8.2 Status Code 1

Bit15	Bit14	Bit13	Bit12	Bit11	Bit10	Bit9	Bit8	Bit7	Bit6	Bit5	Bit4	Bit3	Bit2	Bit1	Bit0
FLT	INT	—	—	—	—	—	—	—	PAE	PAD	WTG	ACL	INF	OPL	ACF

Table 8.3 Status Code 2

- For example, if the code 0x2800 0x0000 is logged we can determine that PS (**Bit13**) and OVP (**Bit11**) are triggered.

NOTICE

Examining each nibble individually facilitates reading the status code. See [table 8.4](#) for a short description of each bit

Bit	[nc=2]Stat	[nc=2]Status Code 2		
0	OTW	Over temperature warning	ACF	Internal communication failure
1	OCP	Over current protection	OPL	Over power lock/clamping
2	OTS	Over temperature on power stage	INF	MOSFET failure
3	OPP	Over power protection	ACL	AC lost or internal power supply fail
4	[nc=2] —	WTG	Wait for trigger	
5	OTP	Over temperature protection	PAD	Parallel disabled
6	RCP	Reverse current protection	PAE	Parallel error
7	RSF	Remote sense fault		
8		—		
9	RI	Remote inhibit	[nc=2] —	
10	UNR	Unregulated on power stage	[nc=2] —	
11	OVP	Over voltage protection	[nc=2] —	
12	UVP	Under voltage protection	[nc=2] —	
13	PS	Protect of system shutdown	[nc=2] —	
14	OSC	Oscillation	INT	RESERVE: interlock event
15	LV	Low voltage	FLT	General Fault

Table 8.4 Status Description

Step 8. Press the **F4 softkey** to view the available **Trigger Sources**.

- Datalog can be triggered in three ways: **Manual**, **Digital IO**, and **Remote**.
 - **Manual:** Select to use manual trigger. The trigger softkey will be available as Datalog Start/Stop.
 - **Digital IO:** Select to use the digital I/O pins to receive a trigger.
 - **Remote:** Select to receive a trigger from a remote interface.

For Digital IO and Remote the first trigger will turn Data log on. A second trigger

NOTICE

will begin data recording.  will be displayed on the top right when data is being logged.

Step 9. Press the **F1 softkey** to return to the **Data Logger Settings Menu page 1/2**.

Step 10. Press the **F1 softkey** to initiate **Datalog**.



will be displayed on the top right when data logger is on but not recording. The command INIT:IMM:DLOG will turn on data logger. For **Digital IO** press **Datalog Start/Stop** to turn data logger on.



will be displayed on the top right when data logger is recording. The command TRIG:DLOG:IMM will begin the recording. For **Digital IO** an input high signal to the set pin will turn data logger on.

NOTICE

If **Trigger Source** is set to manual pressing **Datalog Start/Stop** will start/stop recording without a second signal.

Utility Menu

The Utility Menu consist of the following submenus:

9.1	User Settings	84
9.1.1	Key Lock Input	84
9.1.2	Beep Sound	84
9.1.3	Shortcuts	85
9.1.4	Date and Time	85
9.1.5	Screen Intensity	85
9.1.6	Configuring User Settings	86
9.2	Remote Interfaces	87
9.2.1	USB	87
9.2.2	LAN	89
9.2.3	Configuring LAN Settings	90
9.3	LAN Status	91
9.4	GPIB	92
9.5	Test/Admin	93
9.5.1	Self-Test	93
9.5.2	Security	94
9.6	Error Log	96
9.6.1	Saving the Error Log	97
9.6.2	Clear the Error Log	97
9.7	Help	98

9.1 User Settings

The user settings encompass the adjustable parameters that determine how the user interacts with the load. These settings allow user to customize and control the behavior of the front panel, Display, shortcut keys, etc.

The HVL series is equipped with the following user settings:

9.1.1 Key Lock Input

The Key Lock Input function ensures the security and integrity of load settings and parameters. With this function enabled, the DC load's front panel controls are locked, preventing accidental or unauthorized changes to critical load configurations.

This feature is particularly useful in situations where precise load settings are crucial for accurate testing or when maintaining consistent load conditions is essential.

To make adjustments or modifications to the load settings, the user must first unlock the Key Lock Input by following the sequence; press **Utility button**> **Utility softkey**> **User Settings** > **toggle Key Lock Input off**.

9.1.2 Beep Sound

The beep sound setting controls the audible feedback generated by the load during certain operations or events. By enabling or disabling the beep sound, users can customize their experience and adjust the load's audio notifications to align with their preferences and working environment.

When the beep sound setting is activated, the DC load emits audible signals to indicate various events, such as over protection settings being triggered or error conditions being reported. These beeps serve as a helpful auditory feedback mechanism, providing users with real-time information about the load's status or changes in its operation.

9.1.3 Shortcuts

The Programmable Keys are customizable keys found on the front panel. These keys provide a flexible and personalized way to streamline workflows, enhance productivity, and improve user experience.

The HVL series provides 3 programmable keys; **S1**, **S2**, and **S3**. Each of these keys can be programmed to function as shortcuts to the following menus:

- **Over Protection**
- UV Inhibit
- OSC Protection
- **Input Settings**
- Parallel Settings
- **List Setup**
- Transient Mode
- **LAN Status**
- **Error Log**
- **Help**

9.1.4 Date and Time

The date and time settings options configure the date and time parameters on the device. These settings enable users to synchronize the current date and time information. This ensures that the load's internal clock is aligned with the correct time reference, providing accurate timestamps for data logging or error logging.

9.1.5 Screen Intensity

The screen intensity setting allows users to adjust the brightness or intensity of the screen's backlight. By modifying this setting, users can customize the visual experience to match their preferences and optimize visibility in different lighting conditions.

The screen's intensity is represented on a scale from 1 to 10. With 10 being the brightest option and 1 the dimmest.

Increasing the intensity enhances visibility in well-lit environments, making content on the screen more distinct and easier to read. On the other hand, reducing the intensity lowers the brightness, which can be helpful in low-light situations or when working in darkened environments to prevent eye strain or discomfort.

9.1.6 Configuring User Settings

To configure the user settings:

Step 1. Press the **Utility button** > **Utility softkey** > **User Settings** to enter the **User Settings** menu.



Figure 9.1 User Settings Menu

Step 2. Press the **softkey** corresponding to the desired parameter.
Use the numeric keypad to enter the appropriate value

- For **State** parameters, pressing the softkey will toggle the state between **Enable** and **Disable**.

9.2 Remote Interfaces

The remote interface function enables remote control and communication between the load and external devices or systems. This feature allows users to operate and monitor the DC load from a distance, providing convenience, flexibility, and enhanced integration in various applications.

Through the remote interface function, users can establish a connection between the load and a controlling device, such as a computer, programmable logic controller (PLC), or other instrumentation systems. This enables remote configuration, control, and data acquisition, eliminating the need for direct physical interaction with the load.

The remote interface function supports various communication protocols, such as USB, Ethernet, and GPIB (General Purpose Interface Bus). This ensures compatibility and interoperability with a wide range of devices and systems, facilitating seamless integration into existing setups.

Once connected, users can remotely adjust load parameters, set test conditions, initiate tests, and monitor data. This allows for remote operation in applications where physical access to the load may be challenging, unsafe, or impractical.

9.2.1 USB

The HVL series supports USBVCP and USBTMC.

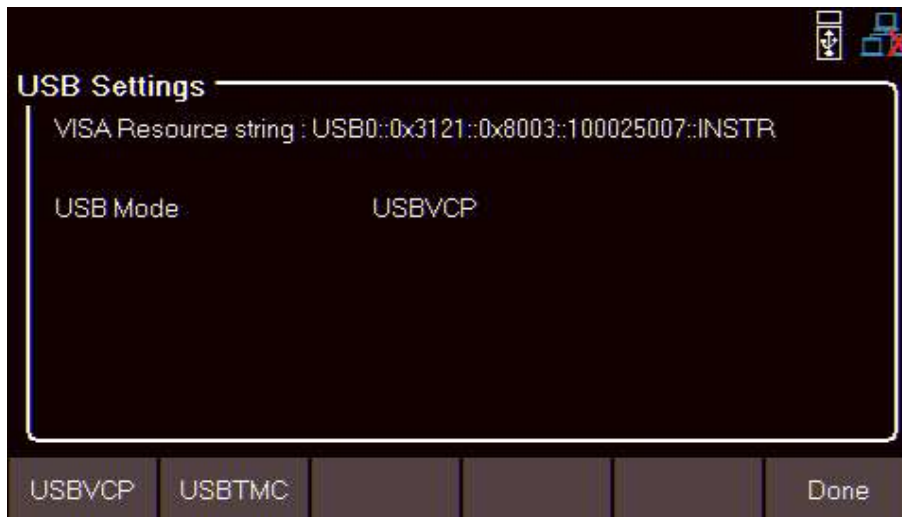

Figure 9.2 USB Settings

The VISA Resource string provides the following information:

USB0::<Vendor ID>::<Product ID>::<Serial Number>:INSTR

<Vendor ID> = 0x3121

<Product ID> = 0x000b for

<Serial Number> = XXXXXXXXX

USBTMC

The USBTMC (USB Test and Measurement Class) interface is a standardized protocol used for communication and control between test and measurement instruments and computers via USB (Universal Serial Bus) connections. It provides a reliable and efficient means of transferring data and commands between the computer and the instrument, enabling seamless integration and control of various measurement devices.

The USBTMC interface allows test and measurement instruments, to be recognized and configured as USB devices by the computer. This enables easy plug-and-play functionality and compatibility across different platforms, as the USBTMC protocol is supported by most operating systems.

To access the USBTMC from a PC, the NI-VISA driver has to be installed. It can be found on the National Instruments website.

USBVCP

USBVCP (USB Virtual COM Port) is a communication protocol that emulates a traditional serial COM port over a USB (Universal Serial Bus) connection. It enables the establishment of a virtual serial port between a computer and a peripheral device, allowing bidirectional serial communication between the two.

The USBVCP interface requires the following port settings:

Port Settings	
Baud rate	<input type="text" value="9600"/>
Data bits	<input type="text" value="8"/>
Parity	<input type="text" value="None"/>
Stop bits	<input type="text" value="1"/>
Flow control	<input type="text" value="None"/>

Figure 9.3 USBVCP Port Settings

To access the USB virtual COM from a PC, the USB virtual COM driver has to be installed. It can be found on the web site of B&K Precision.

9.2.2 LAN

The LAN (Local Area Network) interface provides a means for network connectivity and communication between the load and other devices or systems within a local network. This interface allows users to remotely control, monitor, and integrate the DC load into networked environments, providing convenience, flexibility, and enhanced capabilities.

The HVL series is LXI certified. LXI (LAN eXtensions for Instrumentation) LAN certification is a recognized industry standard that ensures compatibility, interoperability, and compliance of instruments and devices with the LXI specification for LAN-based test and measurement systems.

LXI LAN certification guarantees that the certified instrument conforms to the LXI specification, ensuring seamless integration and interoperability with other LXI-compliant devices and software applications. It establishes a common language and protocol VXI-11 for communication and control, enabling users to easily configure, command, and acquire data from multiple instruments within the LXI ecosystem.

The following parameters must be configured in order to establish connectivity over the LAN interface.

IP Mode

The IP mode setting allows users to define how devices obtain its IP (Internet Protocol) addresses. In the IP mode setting, users have two main options: Static IP and Dynamic IP.

Static IP: In static IP mode, users manually assign a fixed IP address to each device within the LAN network. This means that the IP address remains constant and does not change unless manually reconfigured. Static IP mode provides stability and predictability as devices always have the same IP address, which can be beneficial for applications that require consistent and controlled network communication.

Dynamic IP (DHCP): In dynamic IP mode, the LAN network utilizes a DHCP (Dynamic Host Configuration Protocol) server to automatically assign IP addresses to devices within the network. Devices request an IP address from the DHCP server, which dynamically assigns an available IP address from a pool. Dynamic IP mode simplifies network administration as IP addresses are managed centrally and can be easily reassigned to devices as needed. It is commonly used in larger networks where frequent addition or removal of devices occurs.

NOTICE

When IP Mode is set to Static IP the rest of the LAN parameters will have to be configured manually.

9.2.3 Configuring LAN Settings

To configure the LAN settings:

Step 1. Press the **Utility button** > **Utility softkey** > **I/O Config** > **LAN Settings** to enter the **LAN Settings** menu.

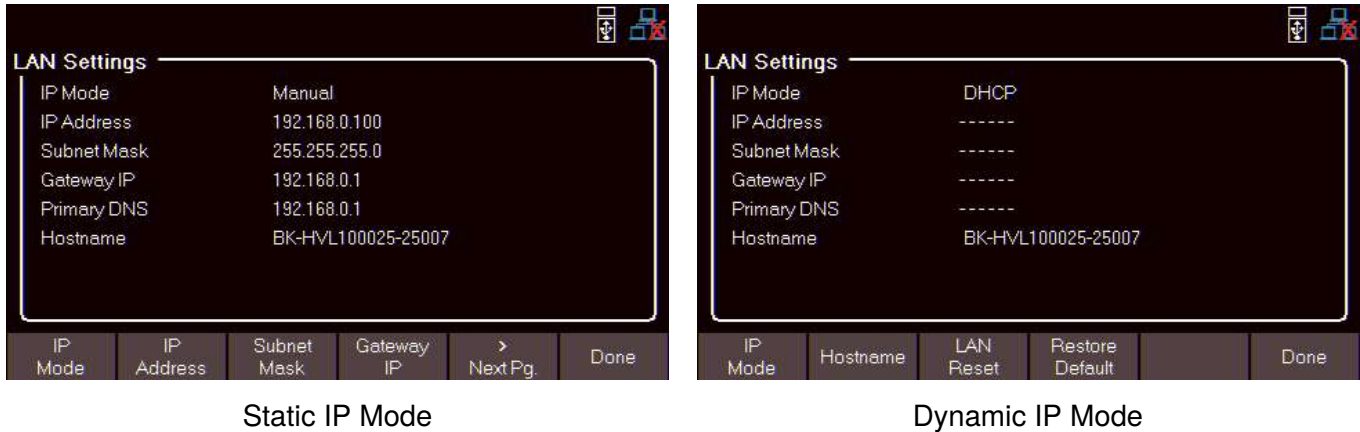

Figure 9.4 LAN Settings Menu

Step 2. Press the **softkey** corresponding to the desired parameter.

Step 3. Use the numeric keypad to enter the appropriate value.

- For **State** parameters, pressing the softkey will toggle the state between **Enable** and **Disable**.

NOTICE

LAN Reset sets all LAN settings and webpage passwords to its default values, while **Restore Default** only sets the LAN settings to default but does not affect webpage passwords.

9.3 LAN Status

A LAN Status function is a feature that provides information about the status of a local network. It allows users to monitor the connectivity of the load.

The LAN Status function provides details such as:

- **MAC address**
- **IP Address**
- **Subnet Mask**
- **Gateway IP**
- **Primary DNS**
- **DNS Hostname**
- **mDNS Hostname**

To view the LAN Status page press the **Utility button**> **Utility softkey**> **I/O Config** > **LAN Status**.



Figure 9.5 LAN Status

9.4 GPIB

The GPIB (General Purpose Interface Bus), also known as IEEE 488, is a standard communication interface. It is primarily designed to facilitate communication between various devices.

The GPIB interface provides a common method for connecting multiple devices and allows them to exchange data and commands over a shared bus. It utilizes a parallel bus architecture, consisting of a host controller (such as a computer) and multiple devices connected via a cable.

Key Features

Key features of the GPIB interface include:

- **Data Transfer:** The GPIB supports fast and reliable data transfer between devices. It allows for both uni-directional and bi-directional communication, enabling devices to send and receive data seamlessly.
- **Addressing:** Each device connected to the GPIB bus is assigned a unique address. This addressing scheme ensures that data is sent and received accurately between the intended devices.
- **Command/Control Signals:** The GPIB supports a set of standardized control signals, such as ATN (attention), REN (remote enable), and EOI (end or identify). These signals help coordinate and synchronize the operation of multiple devices on the bus.
- **Daisy-Chaining:** Multiple devices can be daisy-chained together using the GPIB interface, allowing for easy expansion and scalability of the system. This simplifies the setup and management of complex measurement or control systems.

To configure the GPIB Address of the load press the **Utility button** > **Utility softkey** > **I/O Config** > **GPIB** and use the numeric keypad to enter the desired address.

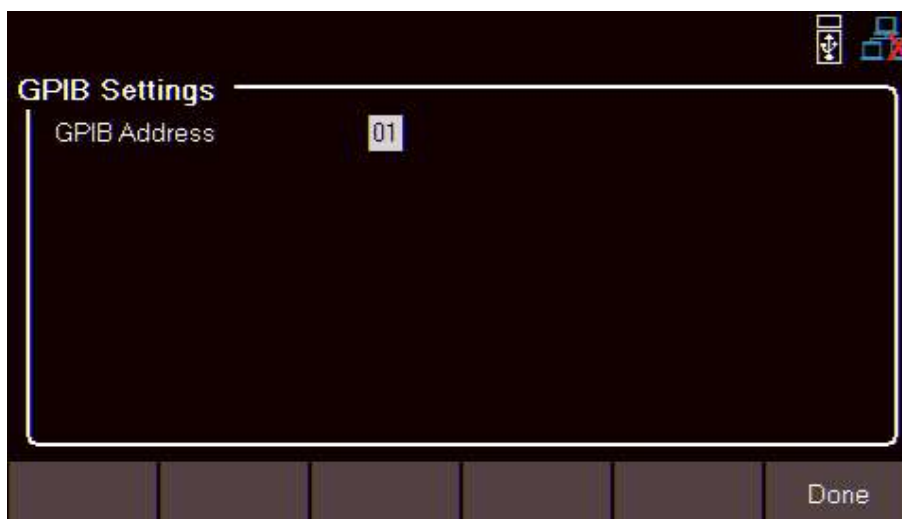

Figure 9.6 GPIB

9.5 Test/Admin

The test and admin menu provides two primary functions: conducting an assessments of the loads state and provide administrative capabilities.

9.5.1 Self-Test

The self-test function performs a diagnostic tests to verify proper functioning. It allows the DC load to check its internal components to provide a pass fail result on the load's state and module.

To perform a self-test press the **Utility button** > **Utility softkey** > **Test/Admin** > **Self-Test** > **Run**.

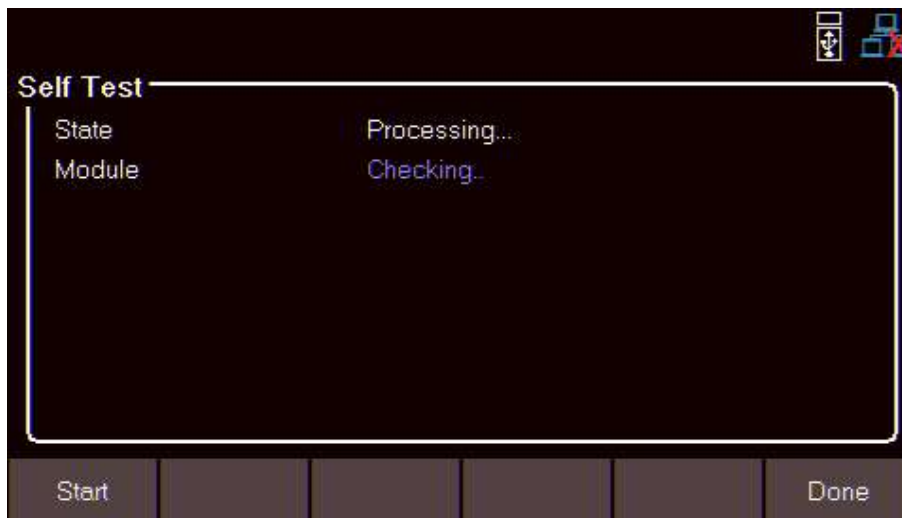

Figure 9.7 Self-Test

Once the test is complete, if no issues were reported the instrument will display:



Figure 9.8 Self-Test Complete

9.5.2 Security

The security page of a DC load refers to a dedicated section safeguarding the load's functions and features from unauthorized access. This function/features are safeguarded since miss used of them could lead to impairment of the loads operation.

The security page encompasses the following functions/features:

Calibration

The calibration function allows for the adjustment and verification of the load's measurement accuracy and performance. Calibration ensures that the load provides accurate and reliable measurements of voltage, current, and power.

Firmware Update

The firmware update function allows user to update firmware to enhance or address bugs.

NISPOM

The NISPOM function refers to the instrument function to completely wipe: settings, list memory, help files, and hex files from the instrument.

Restore FAC. CAL.

The "Restore Factory Cal" function allows users to reset the load's calibration settings back to the original factory calibration. It enables users to revert to the load's initial calibration values in cases where calibration adjustments have been made or when there is a need to restore the load's accuracy to its factory specifications.

To access the functions/features located in the security section follow the steps below:

Step 1. Press the **Utility button** > **Utility softkey** > **Test/Admin** > **Security**.

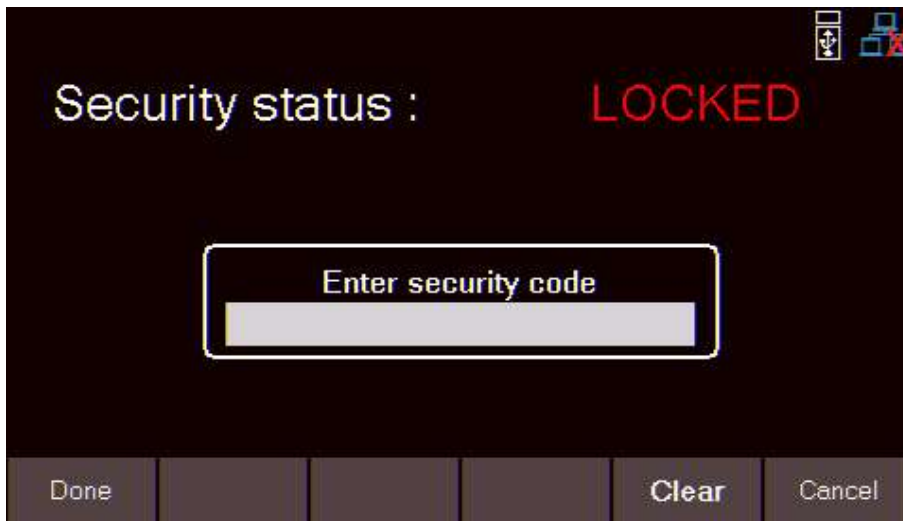

Figure 9.9 Security Status Locked

NOTICE

The **Security Settings** are locked and be accessed by entering the default code **13579**.

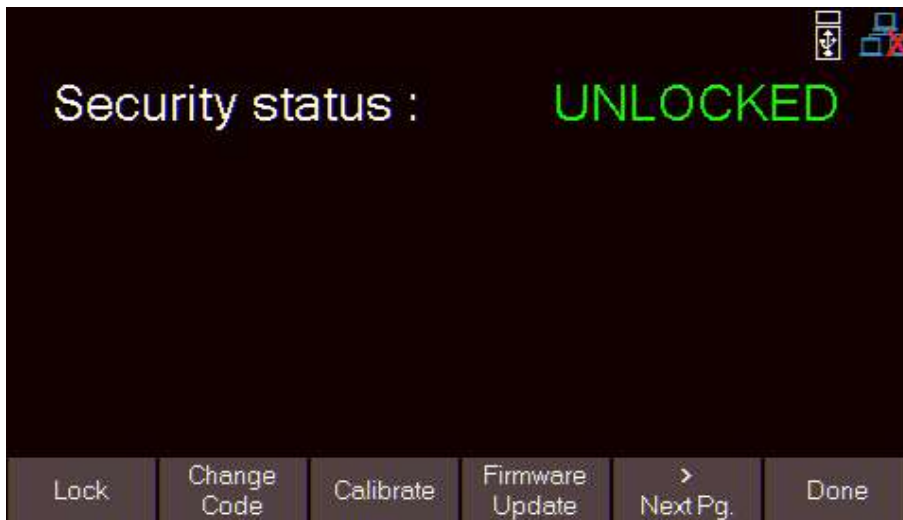

Figure 9.10 Security Status Unlocked

NOTICE

The default password can be change in the Change Code menu. If the set code is forgotten contact B&K Precision customer support.

Step 2. Press the **softkey** corresponding to the desired parameter.

9.6 Error Log

The error log can store up to 50 previously triggered error codes.

The error log function records up to 50 previously triggered error code caused by faults, or abnormal conditions that occur during the operation of the load. It provides a log or history of these events, allowing users to identify and analyze issues.

Each recorded error is timestamped to indicate when the event occurred. This helps in identifying the sequence of events and analyzing patterns or trends related to specific errors.

Errors are placed in the order that they were encountered. 1 being the most recent. The error log displays up to 50 error codes. After reaching 50 error codes no more codes will be reported in the error log. To continue filing error codes the error log list must be cleared

To view the error log press the **Utility button** > **Utility softkey** > **Error Log** .

No.	Time	Error code
01	2023/06/15 13:41:42	0x000b
02	2023/06/15 13:41:42	0x000d

Clear All Save to USB Done

Figure 9.11 Error Log

NOTICE

Table 9.1 provides a description of the reported error codes.

Code	Description
0X01	Over current protection
0X03	Over power protection
0X05	Over temperature protection
0X06	Reverse current protection
0X07	Remote sense fault
0X09	Remote inhibit
0X0b	Over voltage protection
0X0c	Under voltage protection
0X0d	Protect of system shutdown
0X0e	Oscillation
0X10	Internal communication failure
0X12	MOSFET failure
0X14	Wait for trigger
0X1f	General Fault

Table 9.1 Error Log Status Codes

9.6.1 Saving the Error Log

The error log can be saved into a USB flash drive connected to the USB port on the front panel. To save the error log:

Step 1. Press the **Utility button** > **Utility softkey** > **Error Log**> **Save to USB**.

Step 2. Use the navigation keys to navigate to the directory where the file will be saved.

Step 3. press the **Save** softkey.

9.6.2 Clear the Error Log

To clear the error log press the **Utility button** > **Utility softkey** > **Error Log**> **Clear All**.

9.7 Help

To enter the Help menu:

Press the **Utility button** > **Utility softkey** > **Help**.

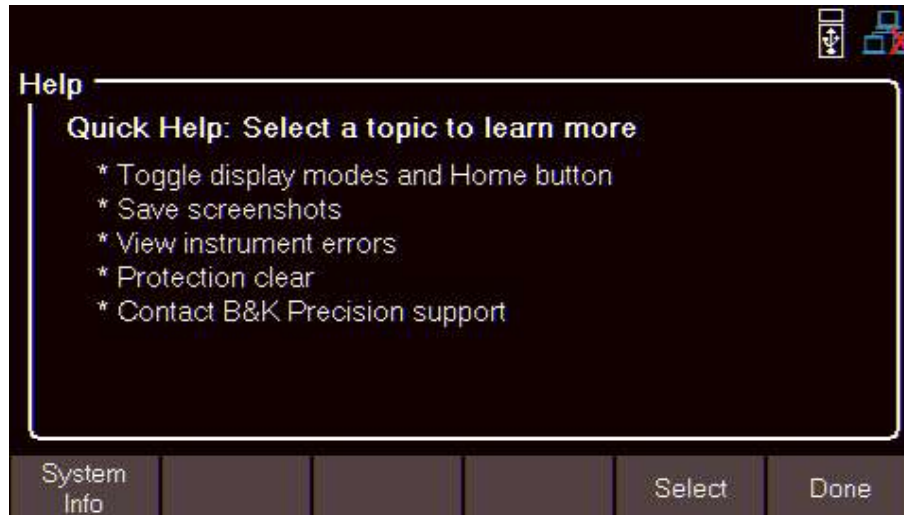

Figure 9.12 Help Menu

Use the navigation keys to select one the help options shown in figure **9.12**.

To select the Quick help topic press the **Enter** button or press the **Select** softkey.

System Info

To view the instrument's general information:

Press the **Utility button** > **Utility softkey** > **Help** > **System Info**.

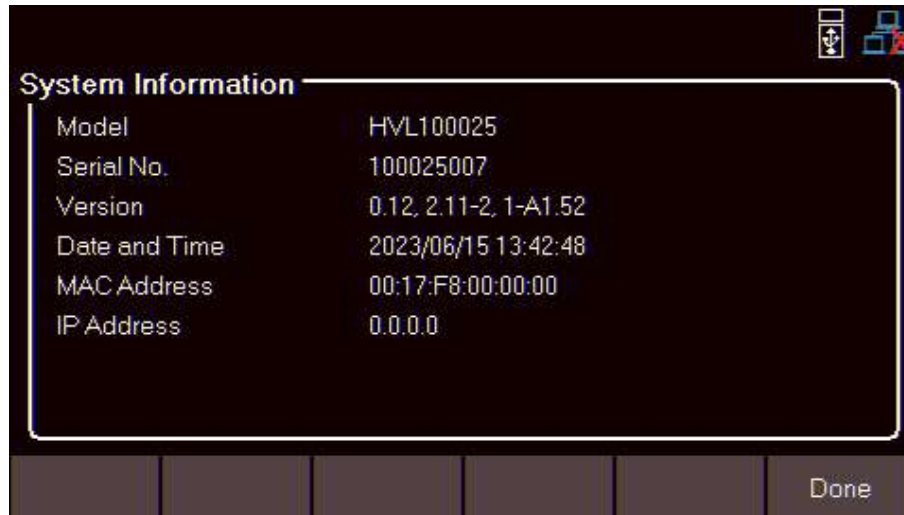

Figure 9.13 System Info

Specifications

Specifications

Note: All specifications apply to the unit after a temperature stabilization time of 30 minutes over an ambient temperature range of 23 °C ± 5 °C.

Model	HVL600150	HVL80075	HVL100025	HVL600300	HVL800150	HVL100050	
Input Ratings							
Input Voltage	0 to 600 V	0 to 800 V	0 to 1000 V	0 to 600 V	0 to 800 V	0 to 1000 V	
Input Current	0 to 150 A	0 to 75 A	0 to 25 A	0 to 300 A	0 to 150 A	0 to 50 A	
Input Power	3000 W			6000 W			
Minimum Operating Voltage	3.5 V	2.0 V	3.5 V	3.5 V	2.0 V	3.5 V	
CV Mode							
Range	Low	0 to 60 V	0 to 80 V	0 to 100 V	0 to 60 V	0 to 80 V	0 to 100 V
	High	0 to 600 V	0 to 800 V	0 to 1000 V	0 to 600 V	0 to 800 V	0 to 1000 V
Programming Readback / Accuracy	±(0.05% + 0.05% FS) ⁽¹⁾						
CC Mode							
Range	Low	0 to 15 A	0 to 7.5 A	0 to 2.5 A	0 to 30 A	0 to 15 A	0 to 5 A
	High	0 to 150 A	0 to 75 A	0 to 25 A	0 to 300 A	0 to 150 A	0 to 50 A
Programming Readback / Accuracy	±(0.05% + 0.05% FS) ⁽¹⁾						
CR Mode							
Range	Low	0.03 Ω to 4 Ω	0.03 Ω to 10.66 Ω	0.2 Ω to 40 Ω	0.015 Ω to 2 Ω	0.015 Ω to 5.33 Ω	0.1 Ω to 20 Ω
	High	4 Ω to 3200 Ω	10.66 Ω to 5000 Ω	40 Ω to 10 kΩ	2 Ω to 1600 Ω	5.33 Ω to 4000 Ω	20 Ω to 5 kΩ
Programming Accuracy (I > 10% of Range)	1% + 0.1% of full range			1% + 0.1% of Full Range			
CW Mode							
Range	Low	0 to 300 W			0 to 600 W		
	High	0 to 3000 W			0 to 6000 W		
Programming Accuracy	±(0.2% + 1% FS)						
Transient Mode (CC Mode)							
TI & T2	100 μs to 10 s						
Accuracy	5 μs ± 100 ppm						
Slew Rate ⁽²⁾	Low	0.05 to 3000 A/ms	0.025 to 1500 A/ms	0.008 to 500 A/ms	0.1 to 6000 A/ms	0.05 to 3000 A/ms	0.017 to 1000 A/ms
	High						
External Programming							
VMON Accuracy	0.1% + 0.1% FS						
IMON Accuracy	0.1% + 0.1% FS						
Input Impedance	210 kΩ ± 5%						

(1) Applies when set voltage (CV mode) or set current (CC mode) is greater than 0.2% of full scale.

(2) The slew rate specifications are not warranted, but are descriptions of typical performance. The actual transition time is defined as the time for the input to change from 10% to 90%, or vice versa, of the programmed current values. In case of very large load changes, e.g. from no load to full load, the actual transition time will be larger than the expected time. The load will automatically adjust the slew rate to fit within the range (high or low) that is closest to the programmed value.

Specifications (cont.)

Note: All specifications apply to the unit after a temperature stabilization time of 30 minutes over an ambient temperature range of 23 °C ± 5 °C.

Model	HVL600150	HVL80075	HVL100025	HVL600300	HVL800150	HVL100050
Programmable Protection						
Voltage (OVP)						
Range	0.394 V to 630 V	0.525 V to 840 V	0.656 V to 1050 V	0.394 V to 630 V	0.525 V to 840 V	0.656 V to 1050 V
Accuracy	0.2% + 0.788 V	0.2% + 1.05 V	0.2% + 1.313 V	0.2% + 0.788 V	0.2% + 1.05 V	0.2% + 1.313 V
Current (OCP)						
Range	0.098 A to 157.5 A	0.049 A to 78.75 A	0.016 A to 26.25 A	0.197 A to 315 A	0.098 A to 157.5 A	0.033 A to 52.5 A
Accuracy	0.2% + 0.197 A	0.2% + 0.098 A	0.2% + 0.033 A	0.2% + 0.394 A	0.2% + 0.197 A	0.2% + 0.066 A
Under Voltage Lockout (UVL)						
Range	0.45 V to 600 V	0.6 V to 800 V	0.75 V to 1000 V	0.45 V to 600 V	0.6 V to 800 V	0.75 V to 1000 V
Accuracy	2.5% + 0.75 V	2.5% + 1 V	2.5% + 1.25 V	2.5% + 0.75 V	2.5% + 1 V	2.5% + 1.25 V
General						
AC Input	100 VAC to 240 VAC ± 10%, 47 to 63 Hz					
Operating Temperature	41 °F to 104 °F (5 °C to 40 °C)					
Dimensions (H x W x D)	5.24" x 16.87" x 26.18" (133 x 428.4 x 665 mm)			8.74" x 16.87" x 24.21" (222 x 428.4 x 615 mm)		
Weight	48.5 lbs (22 kg)			73.8 lbs (33.5 kg)		
Warranty	3 Years					
Standard Accessories	Power cord, removable input protection cover, and certificate of calibration					
Regulatory Compliance						
Safety	Low Voltage Directive (LVD) 2014/35/EU, EN61010-1:2010+A1, cTUVus certification mark ⁽³⁾ fulfills US (UL 61010-1:2012) and Canadian (CAN/CSA-C22.2 NO. 61010-1-12) safety standards					
Electromagnetic Compatibility	EMC Directive 2014/30/EU, EN61326-1:2013					

(3) Tested and certified by a Nationally Recognized Testing Laboratory (NRTL), accredited by OSHA.

Service Information

Warranty Service: Please go to the support and service section on our website at bkprecision.com to obtain an RMA #. Return the product in the original packaging with proof of purchase to the address below. Clearly state on the RMA the performance problem and return any leads, probes, connectors and accessories that you are using with the device.

Non-Warranty Service: Please go to the support and service section on our website at bkprecision.com to obtain an RMA #. Return the product in the original packaging to the address below. Clearly state on the RMA the performance problem and return any leads, probes, connectors and accessories that you are using with the device. Customers not on an open account must include payment in the form of a money order or credit card. For the most current repair charges please refer to the service and support section on our website.

Return all merchandise to B&K Precision Corp. with prepaid shipping. The flat-rate repair charge for Non-Warranty Service does not include return shipping. Return shipping to locations in North America is included for Warranty Service. For overnight shipments and non-North American shipping fees please contact B&K Precision Corp.

Include with the returned instrument your complete return shipping address, contact name, phone number and description of problem.

B&K Precision Corp.
22820 Savi Ranch Parkway
Yorba Linda, CA 92887
bkprecision.com
714-921-9095

LIMITED THREE-YEAR WARRANTY

B&K Precision Corp. warrants to the original purchaser that its products and the component parts thereof, will be free from defects in workmanship and materials for a period of **13years** from date of purchase.

B&K Precision Corp. will, without charge, repair or replace, at its option, defective product or component parts. Returned product must be accompanied by proof of the purchase date in the form of a sales receipt.

To help us better serve you, please complete the warranty registration for your new instrument via our website www.bkprecision.com

Exclusions: This warranty does not apply in the event of misuse or abuse of the product or as a result of unauthorized alterations or repairs. The warranty is void if the serial number is altered, defaced or removed.

B&K Precision Corp. shall not be liable for any consequential damages, including without limitation damages resulting from loss of use. Some states do not allow limitations of incidental or consequential damages. So the above limitation or exclusion may not apply to you.

This warranty gives you specific rights and you may have other rights, which vary from state-to-state.

B&K Precision Corp.
22820 Savi Ranch Parkway
Yorba Linda, CA 92887
www.bkprecision.com
714-921-9095

Version: June 5, 2024