

User Manual

MR Series High Voltage Multi-Range DC Power Supplies

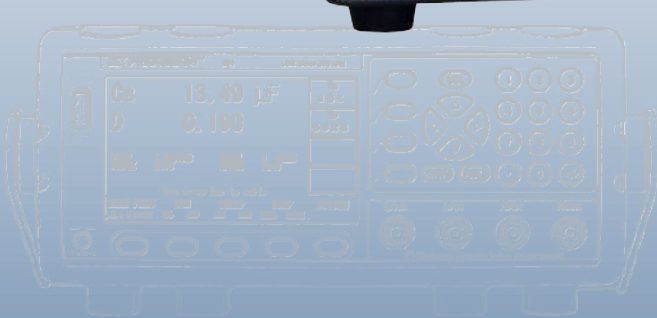

Safety Summary

The following safety precautions apply to both operating and maintenance personnel and must be followed during all phases of operation, service, and repair of this instrument.

WARNING

Before applying power to this instrument:

- Read and understand the safety and operational information in this manual.
- Apply all the listed safety precautions.
- Verify that the voltage selector at the line power cord input is set to the correct line voltage. Operating the instrument at an incorrect line voltage will void the warranty.
- Make all connections to the instrument before applying power.
- Do not operate the instrument in ways not specified by this manual or by B&K Precision.

Failure to comply with these precautions or with warnings elsewhere in this manual violates the safety standards of design, manufacture, and intended use of the instrument. B&K Precision assumes no liability for a customer's failure to comply with these requirements.

Category rating

The IEC 61010 standard defines safety category ratings that specify the amount of electrical energy available and the voltage impulses that may occur on electrical conductors associated with these category ratings. The category rating is a Roman numeral of I, II, III, or IV. This rating is also accompanied by a maximum voltage of the circuit to be tested, which defines the voltage impulses expected and required insulation clearances. These categories are:

Category I (CAT I): Measurement instruments whose measurement inputs are not intended to be connected to the mains supply. The voltages in the environment are typically derived from a limited-energy transformer or a battery.

Category II (CAT II): Measurement instruments whose measurement inputs are meant to be connected to the mains supply at a standard wall outlet or similar sources. Example measurement environments are portable tools and household appliances.

Category III (CAT III): Measurement instruments whose measurement inputs are meant to be connected to the mains installation of a building. Examples are measurements inside a building's circuit breaker panel or the wiring of permanently-installed motors.

Category IV (CAT IV): Measurement instruments whose measurement inputs are meant to be connected to the primary power entering a building or other outdoor wiring.

WARNING

Do not use this instrument in an electrical environment with a higher category rating than what is specified in this manual for this instrument.

WARNING

You must ensure that each accessory you use with this instrument has a category rating equal to or higher than the instrument's category rating to maintain the instrument's category rating. Failure to do so will lower the category rating of the measuring system.

Electrical Power

This instrument is intended to be powered from a CATEGORY II mains power environment. The mains power should be 115 V RMS or 230 V RMS. Use only the power cord supplied with the instrument and ensure it is appropriate for your country of use.

Ground the Instrument

WARNING

To minimize shock hazard, the instrument chassis and cabinet must be connected to an electrical safety ground. This instrument is grounded through the ground conductor of the supplied, three-conductor AC line power cable. The power cable must be plugged into an approved three-conductor electrical outlet. The power jack and mating plug of the power cable meet IEC safety standards.

WARNING

Do not alter or defeat the ground connection. Without the safety ground connection, all accessible conductive parts (including control knobs) may provide an electric shock. Failure to use a properly-grounded approved outlet and the recommended three-conductor AC line power cable may result in injury or death.

WARNING

Unless otherwise stated, a ground connection on the instrument's front or rear panel is for a reference of potential only and is not to be used as a safety ground. Do not operate in an explosive or flammable atmosphere.

WARNING

Do not operate the instrument in the presence of flammable gases or vapors, fumes, or finely-divided particulates.

WARNING

The instrument is designed to be used in office-type indoor environments. Do not operate the instrument

- In the presence of noxious, corrosive, or flammable fumes, gases, vapors, chemicals, or finely-divided particulates.
- In relative humidity conditions outside the instrument's specifications.
- In environments where there is a danger of any liquid being spilled on the instrument or where any liquid can condense on the instrument.
- In air temperatures exceeding the specified operating temperatures.
- In atmospheric pressures outside the specified altitude limits or where the surrounding gas is not air.
- In environments with restricted cooling air flow, even if the air temperatures are within specifications.
- In direct sunlight.

This instrument is intended to be used in an indoor pollution degree 2 environment. The operating temperature range is 0°C to 40°C and 20% to 80% relative humidity, with no condensation allowed. Measurements made by this instrument may be outside specifications if the instrument is used in non-office-type environments. Such environments may include rapid temperature or humidity changes, sunlight, vibration and/or mechanical shocks, acoustic noise, electrical noise, strong electric fields, or strong magnetic fields.

Do not operate instrument if damaged

WARNING

If the instrument is damaged, appears to be damaged, or if any liquid, chemical, or other material gets on or inside the instrument, remove the instrument's power cord, remove the instrument from service, label it as not to be operated, and return the instrument to B&K Precision for repair. Notify B&K Precision of the nature of any contamination of the instrument.

Clean the instrument only as instructed

WARNING

Do not clean the instrument, its switches, or its terminals with contact cleaners, abrasives, lubricants, solvents, acids/bases, or other such chemicals. Clean the instrument only with a clean dry lint-free cloth or as instructed in this manual. Not for critical applications

WARNING

This instrument is not authorized for use in contact with the human body or for use as a component in a life-support device or system.

Do not touch live circuits

WARNING

Instrument covers must not be removed by operating personnel. Component replacement and internal adjustments must be made by qualified service-trained maintenance personnel who are aware of the hazards involved when the instrument's covers and shields are removed. Under certain conditions, even with the power cord removed, dangerous voltages may exist when the covers are removed. To avoid injuries, always disconnect the power cord from the instrument, disconnect all other connections (for example, test leads, computer interface cables, etc.), discharge all circuits, and verify there are no hazardous voltages present on any conductors by measurements with a properly-operating voltage-sensing device before touching any internal parts. Verify the voltage-sensing device is working properly before and after making the measurements by testing with known-operating voltage sources and test for both DC and AC voltages. Do not attempt any service or adjustment unless another person capable of rendering first aid and resuscitation is present.

Do not insert any object into an instrument's ventilation openings or other openings.

WARNING

Hazardous voltages may be present in unexpected locations in circuitry being tested when a fault condition in the circuit exists.

WARNING

Fuse replacement must be done by qualified service-trained maintenance personnel who are aware of the instrument's fuse requirements and safe replacement procedures. Disconnect the instrument from the power line before replacing fuses. Replace fuses only with new fuses of the fuse types, voltage ratings, and current ratings specified in this manual or on the back of the instrument. Failure to do so may damage the instrument, lead to a safety hazard, or cause a fire. Failure to use the specified fuses will void the warranty.

Servicing

WARNING

Do not substitute parts that are not approved by B&K Precision or modify this instrument. Return the instrument to B&K Precision for service and repair to ensure that safety and performance features are maintained.

For continued safe use of the instrument

- Do not place heavy objects on the instrument.
- Do not obstruct cooling air flow to the instrument.
- Do not place a hot soldering iron on the instrument.
- Do not pull the instrument with the power cord, connected probe, or connected test lead.
- Do not move the instrument when a probe is connected to a circuit being tested.

Compliance Statements

Disposal of Old Electrical & Electronic Equipment (Applicable in the European Union and other European countries with separate collection systems)

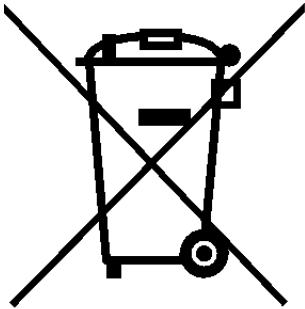

This product is subject to Directive 2002/96/EC of the European Parliament and the Council of the European Union on waste electrical and electronic equipment (WEEE), and in jurisdictions adopting that Directive, is marked as being put on the market after August 13, 2005, and should not be disposed of as unsorted municipal waste. Please utilize your local WEEE collection facilities in the disposition of this product and otherwise observe all applicable requirements.

CE Declaration of Conformity

This instrument meets the requirements of 2006/95/EC Low Voltage Directive and 2004/108/EC Electromagnetic Compatibility Directive with the following standards.

Low Voltage Directive











- UL 61010-1:2012

EMC Directive

- EN 55011:2009+A2:2010
- EN 61000-3-11: 2000
- EN 61000-3-12: 2011
- EN 61000-4-2 / -3 / -4 / -5 / -6 / -8 / -34
- EN 61326-1: 2013
- EN 61326-2-1: 2013

Declaration of Conformity and test report available under request

Safety Symbols

Symbol	Description
	indicates a hazardous situation which, if not avoided, will result in death or serious injury.
	indicates a hazardous situation which, if not avoided, could result in death or serious injury
	indicates a hazardous situation which, if not avoided, will result in minor or moderate injury
	Refer to the text near the symbol.
	Electric Shock hazard
	Alternating current (AC)
	Chassis ground
	Earth ground
	This is the In position of the power switch when instrument is ON.
	This is the Out position of the power switch when instrument is OFF.
	is used to address practices not related to physical injury.

Contents

1	Introduction	9
1.1	Product Overview	9
1.2	Contents	9
1.3	Features	9
1.4	Dimensions	10
1.5	Front Panel	10
1.6	Display	11
1.7	Rear Panel	11
2	Getting Started	12
2.1	Input Power and Fuse Requirements	12
2.2	Fuse Replacement	14
2.3	Rackmount Installation	14
2.4	Output Connections	15
2.5	Preliminary Check	15
2.5.1	Verify AC Input Voltage	15
2.5.2	Connect Power	15
2.5.3	Warm-Up Time	15
2.5.4	Output Check	15
3	Menu Options	18
3.1	Configuration	19
3.1.1	Output Limit Settings	19
3.2	Protect	20
3.2.1	Over Voltage Protection (OVP)	20
3.2.2	Over Current Protection (OCP)	20
3.2.3	Over Power Protection (OPP)	21
3.2.4	CV to CC Protection	22
3.2.5	CC to CV Protection	22
3.3	Configure Voltage/Current Output	23
3.3.1	Setting Voltage	23
3.3.2	Setting Current	23
3.3.3	Local Sense	24
3.4	Voltage/Current Measurement	25
3.4.1	External Analog Control	25
3.4.2	External Control Settings	26
3.5	Local/Analog Control	27
3.6	Voltage Program	28
3.6.1	Voltage Mode	28
3.6.1	Resistor Mode	29
3.6.1	Voltage Monitor	30
3.6.2	Current Monitor	30
3.6.3	Shut Off Control	30
3.7	Output (LED Mode)	31
4	Parallel Operation	33
4.1	Connection and Setup	33
4.2	Slave Unit	34
4.3	Master Unit	34
5	PV Simulation	36
6	Power- On State	38

7	Communication Configuration	39
7.1	USB	39
7.1.1	USBVCP	39
7.1.2	USBTMC	40
7.2	RS232	40
7.3	GPIB	41
7.4	RS485	42
7.5	LAN (Ethernet)	44
7.5.1	Web Server	46
7.6	Error/Event List	51
8	System Menu	52
8.1	Enable/Disable Key Sound	52
8.2	Error Log	52
8.3	Restore Factory Default Settings	53
8.4	Save/Recall Instrument Settings	55
8.4.1	Save Settings	55
8.4.2	Recall Settings	55
8.5	Program Function	56
8.5.1	Repeat and Next	56
8.5.2	Setup a Program	57
8.6	Timer	58
8.7	Slew Rate	59
9	Calibration	60
9.1	Voltage Calibration	61
9.2	Current Calibration	62
9.3	OVP Calibration	63
9.4	OCP Calibration	64
9.5	External Voltage Programming Calibration	65
9.6	External Current Programming Calibration	66
9.7	CC Calibration of External Voltage	67
9.8	CC Calibration of External Current	68
10	Specifications	69
11	Service Information	71
12	LIMITED THREE-YEAR WARRANTY	72

Introduction

1.1 Product Overview



Figure 1.1 MR25080: 250 V / 80 A / 5000 W

B&K Precision models MR3K160120, MR160120, MR25080, MR50040, and MR100020 are high voltage programmable DC power supplies with single outputs that offer the maximum power output up to 5000 watts. By connecting up to *50 power supplies in parallel, a maximum output power can reach up to 250 kW. These power supplies are fully programmable and controllable through analog programming, USB, RS232, RS485, GPIB and Ethernet interface. The front numerical keypad and rotary knob provide a convenient interface for adjusting voltage, current, operating functions and enabling/disabling the output. The MR series power supplies also provide over voltage protection (OVP) and over current protection (OCP) features used to keep the output voltage and current within a specified safety level and preventing damage to the UUT (Unit Under Test).

Model	MR3K160120	MR160120	MR25080	MR50040	MR100020
Output Voltage	0 to 160 V		0 to 250 V	0 to 500 V	0 to 1000 V
Output Current	0 to 120 A		0 to 80 A	0 to 40 A	0 to 20 A
Output Power	3000 W		5000 W		

Table 1.1 Models

1.2 Contents

Please inspect the instrument mechanically and electrically upon receiving it. Unpack all items from the shipping carton, and check for any obvious signs of physical damage that may have occurred during transportation. Report any damage to the shipping agent immediately. Save the original packing carton for possible future reshipment. Every power supply is shipped with the following contents:

- 1 x MR3K160120, MR160120, MR25080, MR50040, or MR100020 Power Supply
- 1 x AC Power Cord
- 1 x Certificate of Calibration
- 1 x Test Report

Note:

Ensure the presence of all the items above. Contact the distributor or B&K Precision if anything is missing.

1.3 Features

- High power output of up to 5000 watts (0-160V/120A) (0-250V/80A) (0-500V/40A) (0-1000V/20A)
- USBVCP(virtual COM)/USBTMC/RS232/RS485/Analog/GPIB and Ethernet interfaces
- Parallel connectivity for up to *50 units
- Adjustable voltage and current slope
- 9 user defined programs with up to 100 steps each
- OVP, OCP, OPP, CV to CC, and CC to CV protection
- Store/recall up to 100 sets of voltage/current settings

*Parallel connectivity and operations can be configured in several different modes, however speed and performance will decrease as each additional units are paralleled together. Refer to section 3.6 Parallel Operation and 4.1 RS485 for more details regarding the configuration, setup, and limitations. If you wish to connect more than 10 units in parallel, we advise to contact us at bkprecision.com for further assistance.

1.4 Dimensions

The MRs power supply’s dimensions are approximately:
 16.5” x 3.5” x 21” (420 x 88 x 532 mm)
 38.6 lbs (17.5 kg)

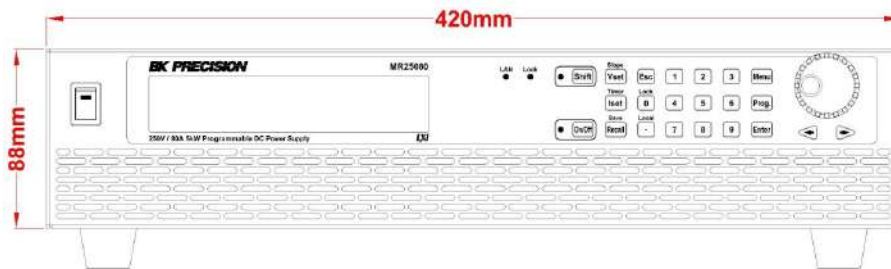
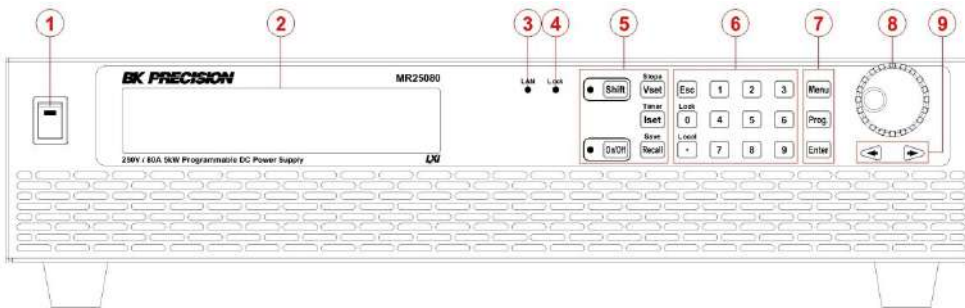

Figure 1.2 Dimensions

1.5 Front Panel

The front panel interface allows for control of the unit.



Item	Description
1	Power Switch
2	Vacuum Fluorescent Display
3	LAN Status indicator
4	Keypad lock indicator
5	Main function keys
6	Numeric keys
7	Function keys
8	Rotary Knob
9	Navigation Keys

1.6 Display

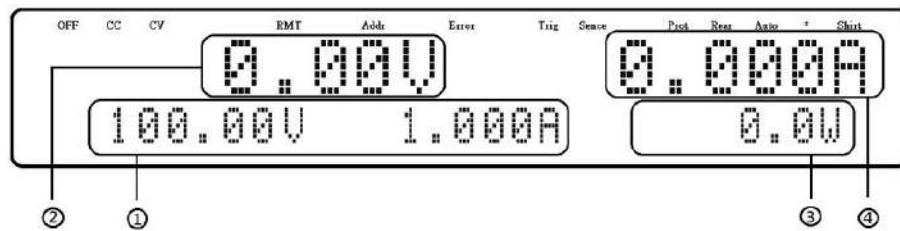
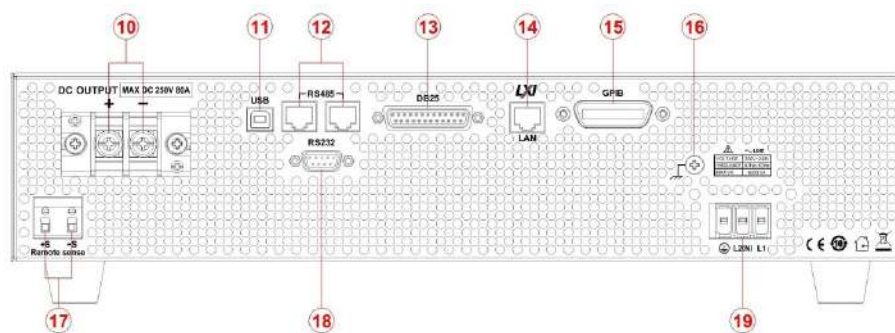

Figure 1.3 Display

Item	Description
1	Measured voltage
2	Settings voltage and current
3	Measured power output
4	Measured current
OFF	Indicates output is disabled
CC	Indicates constant current (CC) operation
CV	Indicates constant voltage (CV) operation
RMT	Indicates remote mode
Addr	Indicates remote communication activity
Error	Indicates an error has occurred
Shift	Indicates shift mode (access to secondary button functions)

1.7 Rear Panel



Item	Description
10	Output
11	USB Interface
12	RS-485 Interface
13	Analog Programming Interface(DB25 Connector)
14	Ethernet (LAN) Interface
15	GPIB Interface
16	Earth ground connection
17	Remote sense terminals
18	RS-232 interface & fuse box
19	AC input receptacle & fuse box

Getting Started



Before connecting and powering up the instrument, please review and go through the instructions in this chapter.

2.1 Input Power and Fuse Requirements

The supply has a universal AC input that accepts line voltage input within:

Model	MR3K160120	MR160120	MR25080	MR50040	MR100020
AC Line Input	200 to 240 VAC \pm 10%, 47 Hz to 63 Hz				
AC Line Phase	Single phase				
Maximum Rated Input Power	4000 VA	6000 VA			

Table 2.1 Input Power and Fuse Requirements

Before connecting to an AC outlet or external power source, be sure that the power switch is in the OFF position and verify that the AC power cord, including the extension line, is compatible with the rated voltage/current and that there is sufficient circuit capacity for the power supply. Once verified, connect the cable firmly.

WARNING

The included AC power cord is safety certified for this instrument operating in rated range. To change a cable or add an extension cable, be sure that it can meet the required power ratings for this instrument. Any misuse with wrong or unsafe cables will void the warranty.



SHOCK HAZARD:

The power cord provides a chassis ground through a third conductor. Verify that your power outlet is of the three-conductor type with the correct pin connected to earth ground.

Follow the instructions below to connect the AC power cable to the AC input of the power supply in the rear panel.

1. First, connect the input receptacle (green terminal block) of the cable to the input terminals of the power supply.
2. Align the power cord housing mounting holes on the left and right side to the screw holes on the power supply.
3. Use only the included screws to fasten and secure the cable housing assembly.

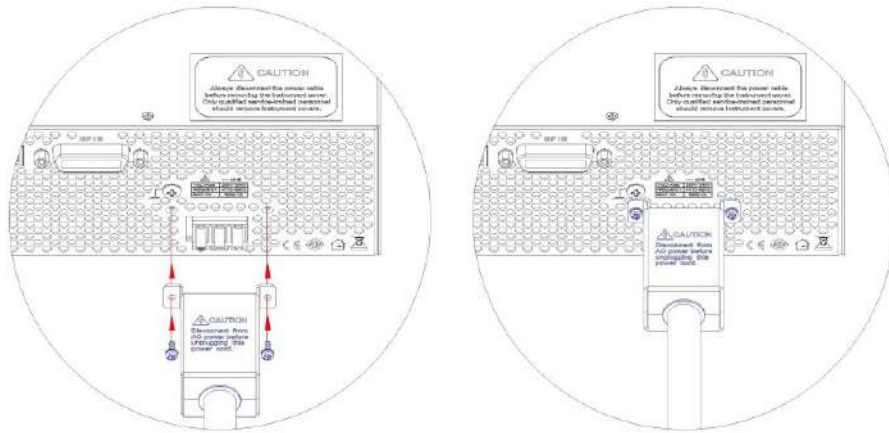

Figure 2.1 AC Power Connection Diagram

Refer to the descriptions below to connect the other end of the AC power cord to the AC distribution panel.

⚠ WARNING

Do NOT plug the AC power cord into the wall socket prior to connecting ALL three AC power wires to the rear panel and securely mount the safety metal housing over the input receptacle. Doing so may create a shock hazard. Connection of this power supply to an AC power source should be made by a qualified electrician or other qualified personnel. Incorrect wiring may damage the power supply or cause a fire hazard

⚠ CAUTION

Connect the three terminals black to line1 (L1), white to line2 (L2) or neutral (N), and green to ground (G) on the other end of the power cord to your AC distribution panel.

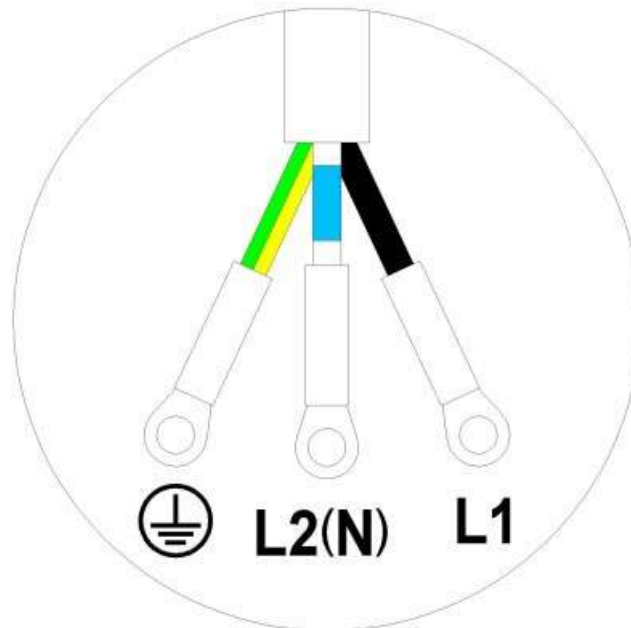

Figure 2.2 AC Power Cord

⚠ CAUTION

Safety agency requirements dictate that there must be a way to physically disconnect the AC mains cable from the unit. A disconnect device, either a switch or circuit breaker must meet the input rating requirements at 30A in 200 Vac. The disconnect device provided in the final installation must be close to the instrument, must be easily accessible, and must be marked as the disconnect device for this instrument.

2.2 Fuse Replacement

⚠ WARNING

This power supply does not require a fuse that is user replaceable. There is an internal fuse, in which if blown, may indicate a malfunction in the unit. In this event, contact B&K Precision.

A disassembling of the case or changing the fuse not performed by an authorized service technician will void the warranty of the instrument.

2.3 Rackmount Installation

The MR series power supplies are designed to fit in a space of two rack units (2U) and can be mounted in a standard 19-inch rack panel or cabinet. Rack mount brackets must be assembled before mounting the unit in a rack. Refer to the following figure to assemble the rack mount brackets.

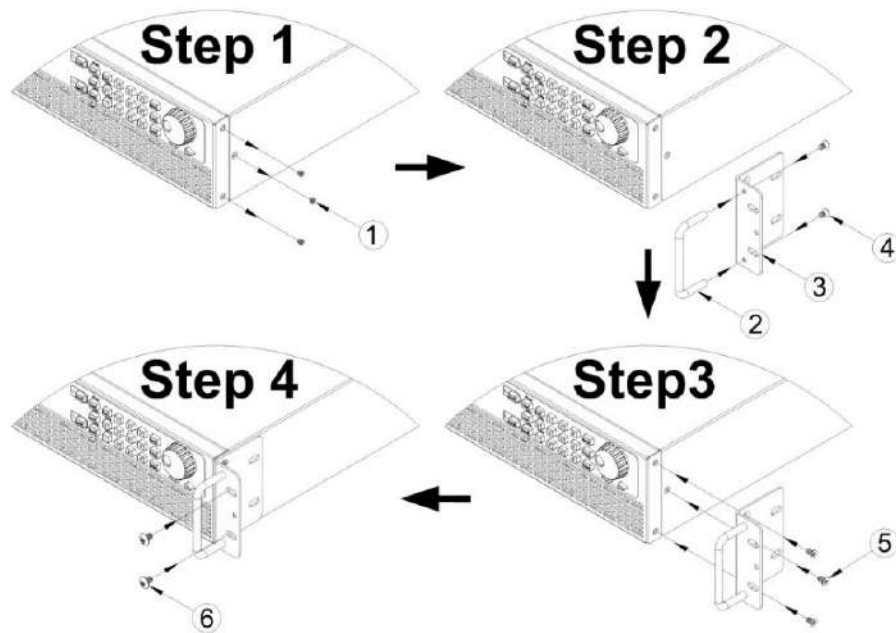

Figure 2.3 Rack Mount Bracket Assembly

2.4 Output Connections

The main DC output terminal is a screw type terminal block located in the rear panel. Due to the high current rating of the power supply, proper wire sizes are necessary for safe connectivity and to prevent wires from overheating. Refer to the below table as a reference for proper wire sizes according to the amount of current used for operation:

WARNING

Before connecting wires to the output terminals, turn OFF the power supply to avoid damage to the instrument and the device under test (DUT). For safety, load wires must have a wire gauge size large enough to prevent overheating when the power supply operates at maximum short circuit output current. It will also prevent large voltage drops from resistances in the wires.



Hazardous voltages may exist at the outputs and the load connections when using a power supply with a rated output greater than 40V. To protect personnel against accidental contact with hazardous voltages, ensure that the load and its connections have no accessible live parts. Ensure that the load wiring insulation rating is greater than to the maximum output voltage of the power supply.

2.5 Preliminary Check

Complete the following steps to verify that the power supply is ready for use.

2.5.1 Verify AC Input Voltage

Verify and check to make sure proper AC voltages are available to power the instrument. The AC voltage range must meet the acceptable specification as explained in “2.1 Input Power and Fuse Requirements”.

2.5.2 Connect Power

Connect AC power cord to the AC receptacle in the rear panel and press the power switch to the (ON) position to turn ON the instrument. On power up, the unit will display its model, shown in the screen below, and then check for the optional modules.

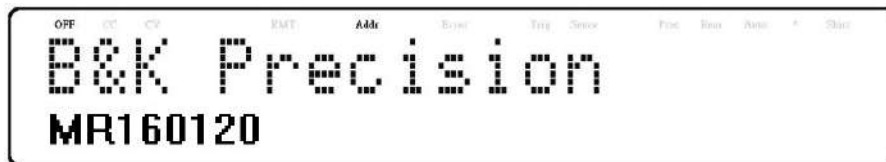

Figure 2.4 Power On Display



2.5.3 Warm-Up Time

The MR series is fully operable upon switching the power ON. However, to reach the specified equipment accuracy, please allow the supply to warm up for at least 15 minutes.





2.5.4 Output Check

Follow the steps below to check voltage output with no load connected.





1. Voltage Check

- Turn ON the power supply. The display will show the OFF annunciator above the voltage display.
 - Enable the output by pressing . After pressing the button the LED next to the button will be lit. The OFF annunciator will change to CV.
 - Using the numeric keypad or the voltage adjust knob and enter a voltage value. The voltage display will now show the value you entered. If entering with numeric keypad, press  first, then enter the value and press .
 - (Optional) You may also verify the output voltage by connecting the (+) and (-) terminals on the rear panel to an external voltmeter. The measured value should match or be within the entered voltage value.
- Follow the steps below to check current output of the power supply.

2. Current Check

- Turn ON the power supply. The display will show the OFF annunciator above the voltage display. Be sure that the output is disabled (the LED next to the  button should not be lit when it is off). If the LED is ON, press  to disable output. Short the (+) and (-) output terminals with test leads, shorting bar, or clip. (Refer to “– Wire Gauge Rating” to select appropriate test leads)
- Using the numeric keypad or the current adjust knob, enter a small current value (i.e. 1.000 A). If entering with numeric keypad, press  first, then enter the value and press . The current display will now show the value you entered.
- Enable the output by pressing , and the LED next to the button will be lit. The OFF annunciator will change to CC.
- (Optional) You may also verify the output current by connecting either the (+) and (-) terminals on the rear panel to an external current meter capable of measuring the current that you set. The measured value should match or be within the entered current value.
- Press the power switch to the OFF position to turn off the power supply, then remove the short on the output terminals.

3. **Check Model and Firmware Version** The model and firmware version can be verified by using the ***IDN?** query remote command. It can also be found from within the menu system by following these steps:

- Press  to enter the menu system.
- Press the  button five times until **SYSTEM** is select. Press . Press the  button one time until **INFORMATION**. Press , and the display will show the following screen:

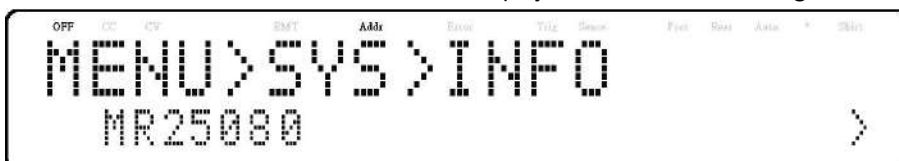

- The model is shown above as MR160120.

- Press  twice again and the firmware version will displayed.

```

OFF  CC  CV  RMT  Addr  Error  Trig  Sense  Pres  Rear  Asta  *  Start
MENU>SYS>INFO
< UI VERSION:1.02 >

```

- The UI firmware is shown above as 1.02.

- Press  once again and the firmware version will displayed.

```

OFF  CC  CV  RMT  Addr  Error  Trig  Sense  Pres  Rear  Asta  *  Start
MENU>SYS>INFO
< CONTROL VERSION:1.02 >

```

- The control firmware is shown above as 1.02.

- Press  once again and the firmware version will displayed.

```

OFF  CC  CV  RMT  Addr  Error  Trig  Sense  Pres  Rear  Asta  *  Start
MENU>SYS>INFO
< INTERFACE VERSION:1.01 >

```

- The interface firmware is shown above as 1.01.

- Press  once again and the firmware version will displayed.

```

OFF  CC  CV  RMT  Addr  Error  Trig  Sense  Pres  Rear  Asta  *  Start
MENU>SYS>INFO
< PFC VERSION:1.H0 >

```

- The PFC firmware is shown above as 1.52.

- Press  three times to exit the menu and return to the normal display.

Menu Options

All settings and parameters can be configured from the built-in menu system of the power supply. To access the menu, press **Menu**.

The menu system is divided into 6 sections and are organized as follows:

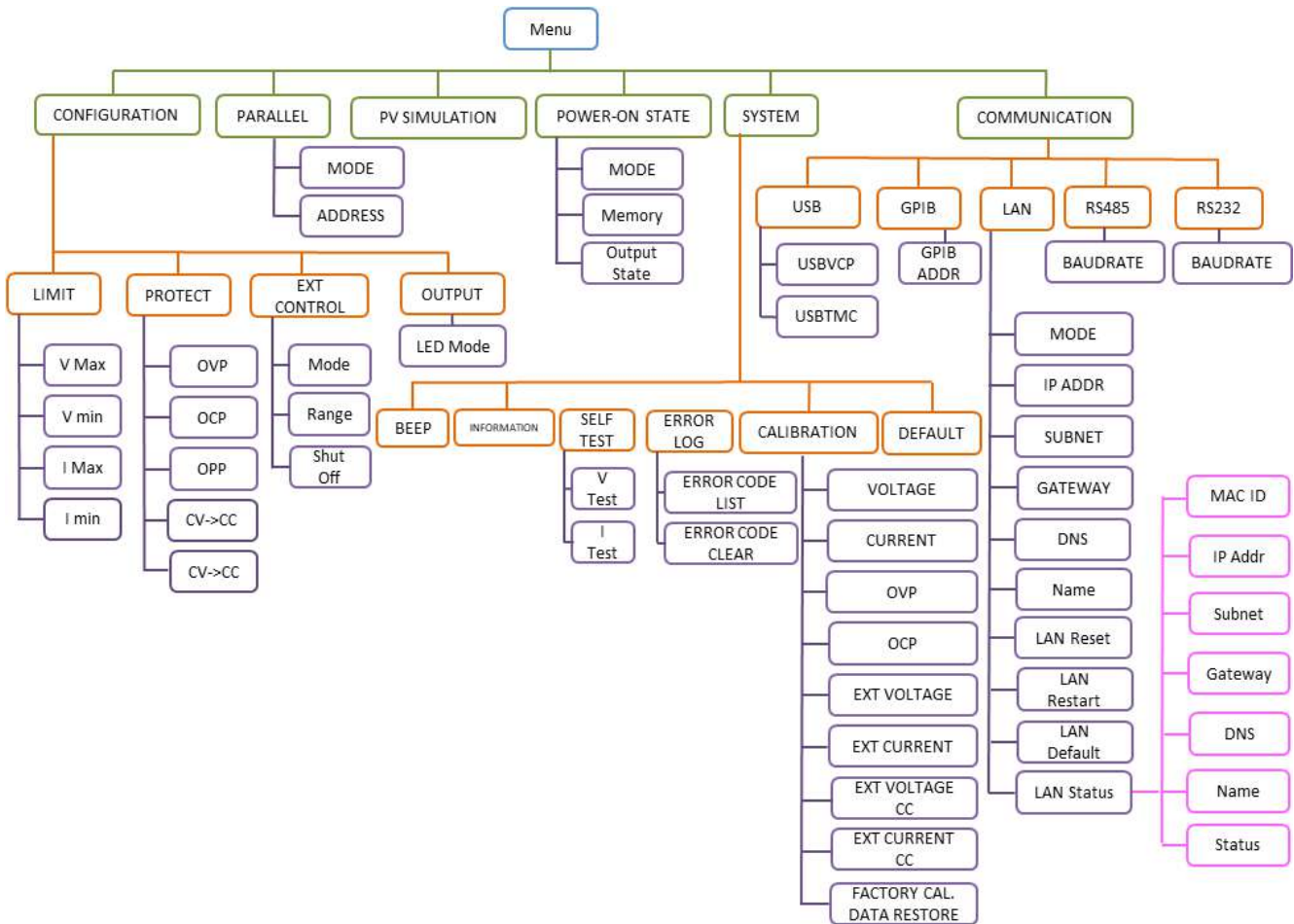

Figure 3.1 Menu Tree

Before using the instrument, it is important to be familiarized with its menu structure and learn how to view or change settings and parameters. Follow the steps below to guide you in selecting menu options.

1. From the normal display, press the **Menu** button to enter the menu.
2. The selected item will be show. Use the **◀▶** keys to move through the menu selections.
3. When the desired menu section is show, press **Enter** to access its menu settings. Below is the display when **CONFIGURATION** is selected.



4. The selected item will be show. Use the keys to move through the menu items. When there is a on the right side of the display, there are more menu items available to select from. Similarly, a will appear on the left side of the display when there are menu items to the left. Use the keys accordingly to select the desired menu item.
5. Press to access the selected menu item.
6. There may be parameters or options to select within each menu item. Follow the same instructions as described in the previous steps to select them. To save changes to a setting, press .
7. To exit the menu at any time, press until the normal.

3.1 Configuration

All setup procedures and settings explained in this section can be accessed from the CONFIGURATION menu. To access this menu, press , select CONFIGURATION, then press .

3.1.1 Output Limit Settings

The voltage or current output limits can be configured to provide limit protection to prevent accidental changes to the output settings. There are four limit values that can be set: voltage maximum (**VMAX**), voltage minimum (**VMIN**), current maximum (**IMAX**), and current minimum (**IMIN**).

Note:



At any time during operation, when you are unable to set to a desired voltage or current, check these limit settings to make sure the set value is within the limit's range.

The shaded area illustrated above is the settable range of the output voltage and current. Follow the steps below to configure the output limits:

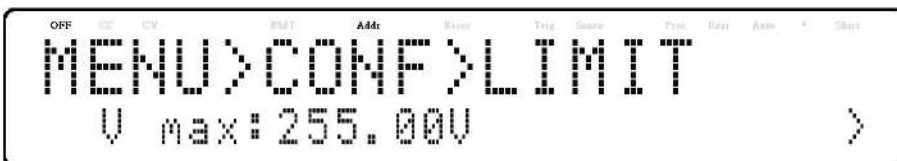
1. From the **CONFIGURATION** menu, select **LIMIT**, then press . The following screen will display:



2. Use the keys to select the limit setting value of V max, V min, I max, and I min. Press to confirm selection.









- Use the numerical keys to set the limit value and press  to confirm the setting.
- Press  several times to exit the menu setting.

3.2 Protect

3.2.1 Over Voltage Protection (OVP)

The MR over voltage protection utilizes a hardware comparator that quickly protects the instrument when the voltage presented at the output terminal exceeds the OVP setting voltage.

Follow the steps below to set the OVP limit:

- Press  button, select CONFIGURATION, then press .
- Press  button one time until PROTECT is select and press . The display will then show OVP,  press.
- Use numerical keys directly or use   keys with the rotary knob to adjust the value. Press  to confirm the OVP value.
- Press  several times to exit the menu setting.

When OVP protection is tripped during operation, the output will turn off and the following OVP status message will display:

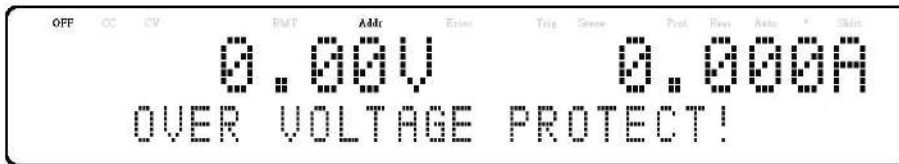











To clear the trip status, press  once.

3.2.2 Over Current Protection (OCP)

Configure Over Current Protection (OCP) The MR overcurrent protection utilizes a hardware comparator that quickly protects the instrument when the current presented at the output terminal exceeds the OCP setting current.

Follow the steps below to set the OCP limit:

- Press  button, select CONFIGURATION, then press .
- Press  button one time until PROTECT is select and press . The display will then show **OVP**.

3. Press  button one time until OCP is displayed, and press  .
4. Use numerical keys directly or use the   keys with the rotary knob to adjust the OCP value. Press the  button to confirm the OCP value.
5. Press  several times to exit the menu setting.

When OCP protection is tripped during operation, the output will turn off and the following OCP status message will display:













To clear the trip status, press  once.

3.2.3 Over Power Protection (OPP)

The MR overpower protection continuously monitors the output power. If it is greater than the OPP setting, it turns off the power supply output to protect the device under test.

Follow the steps below to set the OPP limit:

1. Press  button, select **CONFIGURATION**, then press  .
2. Press  button one time until **PROTECT** is select and press  . The display will then show OVP.
3. Press  button one time until OPP is displayed, and press  .
4. Use numerical keys directly or use the   keys and the rotary knob to adjust the OPP value. Press the  button to confirm the OPP value.
5. Press  several times to exit the menu setting.



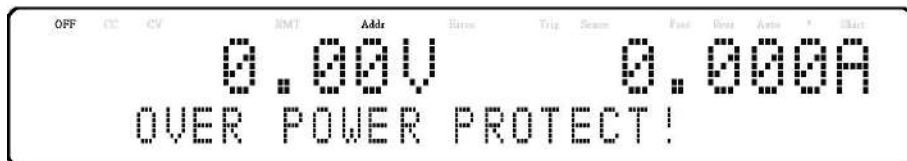



When OPP protection is tripped during operation, the output will turn off and the following OPP status message will display:



To clear the trip status, press  once.

3.2.4 CV to CC Protection

The MR CV to CC protection monitors the transition between constant voltage to constant current mode. If this event occurs, the output of the power supply will turn off. Follow the steps below to set the CV to CC limit:

1. Press  button, select **CONFIGURATION**, then press  .
2. Press  button one time until PROTECT is select and press  . The display will then show OVP.
3. Press the  button three times until CV to CC is displayed .
4. Use rotary to select the CV to CC ON or OFF followed by  .
5. Press  several times to exit the menu setting.



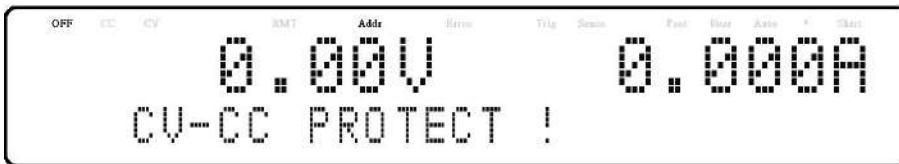



When CV to CC protection is tripped during operation, the output will turn off and the following CV to CC status message will display:



To clear the trip status, press  once.

3.2.5 CC to CV Protection

The MR CC to CV protection monitors the transition between constant voltage to constant current mode. If this event occurs, the output of the power supply will turn off. Follow the steps below to set the CC to CV limit:

1. Press  button, select **CONFIGURATION**, then press  .
2. Press  button one time until PROTECT is select and press  . The display will then show OVP.
3. Press the  button three times until CC to CV is displayed .
4. Use rotary to select the CC to CV ON or OFF followed by  .
5. Press  several times to exit the menu setting.

When CC to CV protection is tripped during operation, the output will turn off and the following CC to CV status message will display:

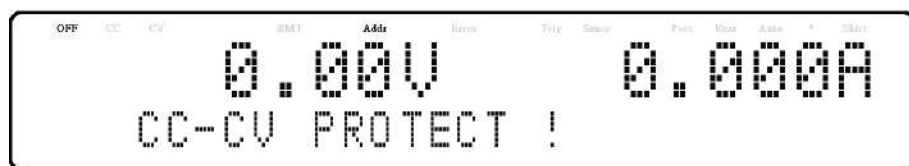

To clear the trip status, press **Esc** once.

3.3 Configure Voltage/Current Output

Voltage and current can be set from the front panel. Remote sense is also available on the rear panel for voltage compensation at the output.

3.3.1 Setting Voltage

Follow the steps below to set the output voltage:

1. From the normal front panel display, users can use either the voltage adjust knob or the numeric keypad to enter the setting voltage.

2. If entering using numeric keypad, press **Slope Vset** first so that the cursor selects the voltage display. Then, enter the value and press **Enter** to set the voltage.
3. To change the cursor position use the **Left/Right** keys. The voltage can be adjusted with the rotary knob.

When output is ON, the user can use the rotary to adjust the voltage value when the output is in constant voltage (CV) mode. The output value will change simultaneously with the adjusted value. This is so called on-the-fly function that allows user to easily change the output value if the test is needed.

3.3.2 Setting Current

1. From the normal front panel display, users can use either the current adjust knob or the numeric keypad to enter the setting current.

2. If entering using numeric keypad, press **Timer Iset** to select the current parameter. Then, enter the value and press **Enter** to set the current.
3. To change the cursor position use the **Left/Right** keys. The current can be adjusted with the rotary knob.

When output is ON, the user can use the rotary to adjust the current value when the output is in constant current (CC) mode. The output value will change simultaneously with the adjusted value. This is so called on-the-fly function that allows user to easily change the output value if the test is needed.

3.3.3 Local Sense

By default, the power supply is set up for local sense. See the figure 3.2 for the Remote and Local Sense setup.

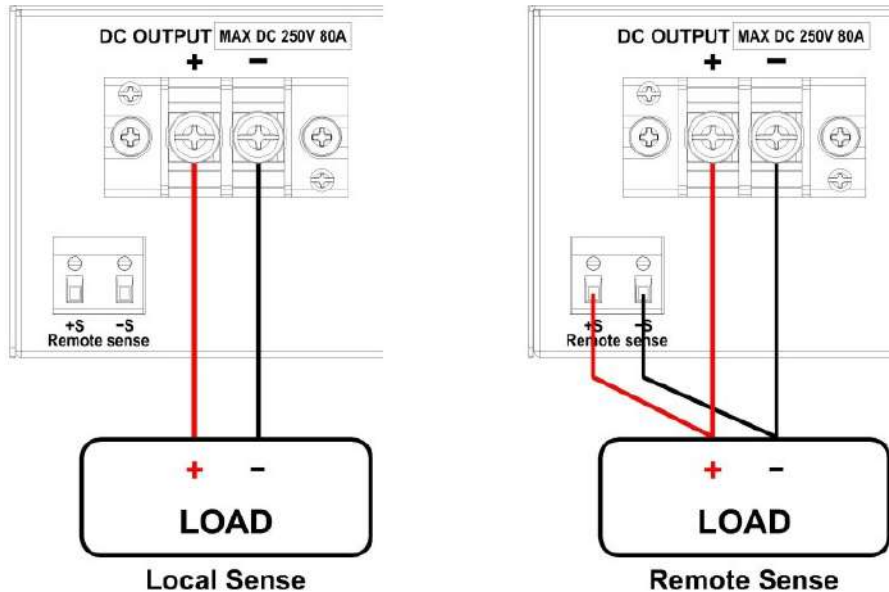

Figure 3.2 Local Sense

When local sense is selected, the positive lead (+) of the DC output is connected to the positive end (+) of the load and the negative lead (-) of the DC output is connected to the negative end (-) of the load.

When this sensing mode is selected the wires connecting between DC outputs to the load must be as short as possible. The local sense is the default configuration.

WARNING

DO NOT disconnect the wires if remote sense is not used. Doing so will cause erratic behavior and may damage the power supply under certain conditions.



Never connect any power source into any of the four terminals at any time during operation. When output is enabled, **DO NOT** use your hands to touch the terminals or the screws that are designed to tighten wires to the terminals. Doing so may create a shock hazard under high voltage output conditions.

Remote Sense

When remote sense is selected, the positive sense (+S) and positive lead (+) of the DC output are connected to the positive end (+) of the load, whereas negative sense (-S) and negative lead (-) of the DC output are connected to the negative end (-) of the load. To enable remote sense, follow the steps below:

1. Power OFF the supply and disconnect all loads and cables connected to it.
2. Use a small flat blade screwdriver connect the S+ to the DUT's positive (+) terminal, and connect the S- to the DUT's negative (-) terminal.
3. Do not connect any wires to Vo+ and Vo- terminals.
4. Power ON the power supply, and then configure and enable the output. The setup should look like the [figure](#) above.

CAUTION

DO NOT at any time disconnect the wires from the Vs+ and Vs- terminals to the DUT while output is enabled (ON). Doing so may damage the power supply and cause unstable output.

3.4 Voltage/Current Measurement

The display will show the set voltage and current values and the measured values of the output.

System Messages

The MR has built-in sensors to detect system conditions. If a fault status occurred, the error message will show on the display and automatically protect the power supply output. The following display occurs when the fan has failed or stopped turning:



System Message	Description
MEMORY CHECK ERROR !	Cannot read or write the internal non- volatile memory
OVER TEMPERATURE PROTECT !	Internal temperature is too high and the protection mechanism is activated
FAN ERROR !	FAN not functioning
HW Fail OVP	Module hardware over voltage
HW Fail OCP	Module hardware over current
CALIBRATION ERROR !	Calibration cannot be done
AC FREQUENCY ABNORMAL !	AC input frequency is out of range
AC VOLTAGE ABNORMAL !	AC input voltage is out of range
PFC ERROR !	PFC not functioning correctly
POWER OFF !	Power supply is powering off
OUTPUT SHORT CIRCUIT	Output voltage drop too fast
HW Fail BVbus	Module hardware fail

3.4.1 External Analog Control

To control or monitor the output of the power supply using external signals, refer to the following figure of the DB25 connector located in the rear panel. The logical signal L is a TTL compatible signal. The analog signal cannot exceed the range of 0 to 12VDC.

WARNING

DO NOT exceed 12VDC on any of the analog signal pins or TTL voltage on any of the logical signal L pins of the DB25 connector. Doing so will cause erratic behavior and may damage the power supply under certain conditions.

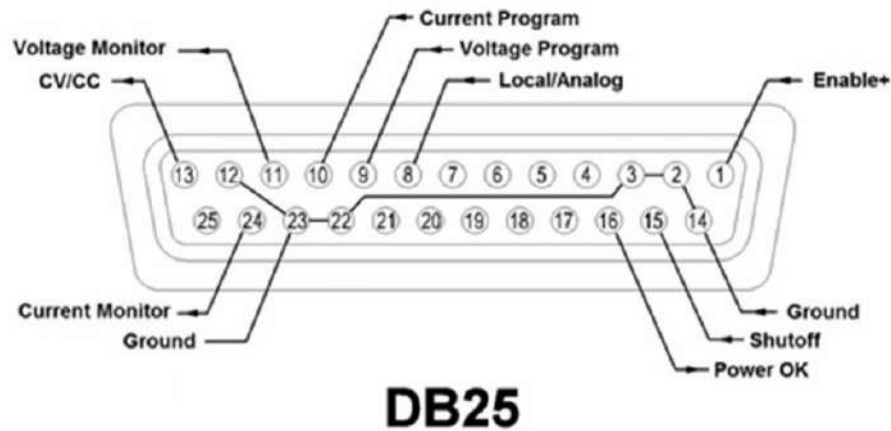

Figure 3.3 DB25 Pinout





Pin	Signal	I/O	Description
1	Enable	I	Open: Output is OFF Short to ground: Output is ON
2	Ground		
3	Ground		
8	Local/Analog	I	Open: Front panel control Short to ground: Rear analog control
9	Voltage Program	I	Input 0-5 V / 0-5 k Ω or 0-10 V / 0-10 k Ω for voltage output setting, full scale input equals maximum output voltage
10	Current Program	I	Input 0-5 V / 0-5 k Ω or 0-10 V / 0-10 k Ω for current output setting, full scale input equals maximum output current
11	Voltage Monitor	O	Output 0-5 V / 0-10 V represents power supply output voltage, full scale output equals maximum output voltage
12	Ground		
13	CV/CC	O	High: Constant voltage Low: Constant current
14	Ground		
15	Shutoff	I	Open: No action Short to ground OFF: Ignore Shutoff LIVE: Output is OFF LATCH: Output is OFF
16	Power OK	O	High: Output is ON Low: Output is OFF
22	Ground		
23	Ground		
24	Current Monitor	O	Output 0-5 V / 0-10 V represents power supply output current, full scale input equals maximum output current

Table 3.1 DB25 Pins

3.4.2 External Control Settings

If you want to use the external mode to control the power, you must enter the menu configures external analog control before entering the external mode.

Follow the steps below:

- Press the  button, select **CONFIGURATION**, then press .
- Press the  button twice times until **EXT CONTROL** is select and press .
- Press  button to set Mode.

External Mode	Description
EXT-V	Program the voltage output by connecting an external DC voltage to Pin 9.
EXT-R	Program the voltage output by connecting an external resistor to Pin 9.

- Press the  button to set the range.

External Range	Description
10V/10K	The external voltage range or resistance range used to control the output voltage full scale is 0-10V /0-10kΩ.
5V/5K	The external voltage range or resistance range used to control the output voltage full scale is 0-5 V /0-5kΩ.

- Press the  button to set Shut Off (Remote Inhibit).

External Shut Off	Description
OFF	The Inhibit input is ignored.
LIVE	Output follow the state of the Inhibit input.
LATCH	The output remains disabled. The latched INH status bit is cleared by sending the OUTPut:PROTection:CLEar command Or press  button from the front panel.

3.5 Local/Analog Control

Pin 8 can be used to select the control mode (local or analog) of the power supply's output. When the input command for this pin is at high level (or open), the control mode will be local. When input command for this pin is at low level (or shorted to GND), the control mode will be analog. If you enter external mode, the front panel will be disabled.

Local/Analog Control

When Enable (Pin 1) open, the output is OFF.

When Enable (Pin 1) short to ground, the output is ON.

Power OK Signal

Pin 16 is used to indicate whether a fault condition is present in the power supply. Normally this pin will output a logic high (5V). When a fault occurs, this pin will output a logic low (0V).

Fault conditions are defined as follows:

1. Overvoltage protection
2. Overcurrent protection
3. Overpower protection
4. CV to CC protection
5. CC to CV protection
6. Over temperature protection
7. AC line failure
8. Enable signal
9. Shutoff signal
10. Remote failure
11. Output off
12. Hardware protection

3.6 Voltage Program

3.6.1 Voltage Mode

Under voltage mode, the user may control the full scale output voltage value through Pin 9, by inputting a voltage level of 0-5 V (0-5 V / 0-5 k Ω mode) or 0-10 V (0-10 V / 0-10 k Ω mode) as shown below.

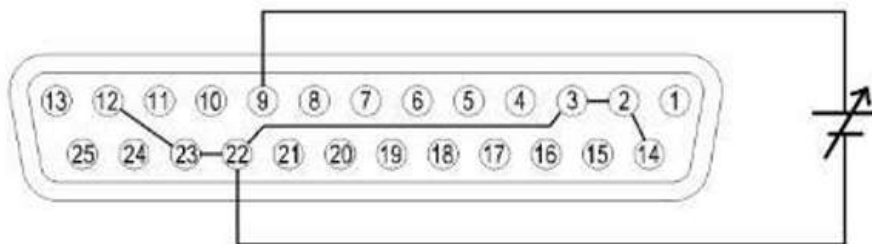

Figure 3.4 Voltage Mode: 0-5 V or 0-10 V

Current Program

Under voltage mode, the user may control the full scale current output value through Pin 10, by inputting a voltage level of 0-5V (0-5 V / 0-5 k Ω mode) or 0-10V (0-10 V / 0-10 k Ω mode) as shown below.

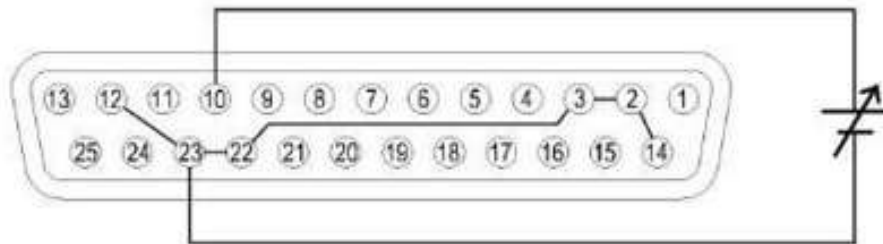

Figure 3.5 Voltage Mode Current Program: 0-5 V or 0-10 V

3.6.1 Resistor Mode

Under resistor mode, the user may control the full scale voltage output value by connecting a resistance value of 0-5 k Ω (0-5 V / 0-5 k Ω mode) or 0-10 k Ω (0-10 V / 0-10 k Ω mode) between Pin 9 and Pin 22 as shown below.

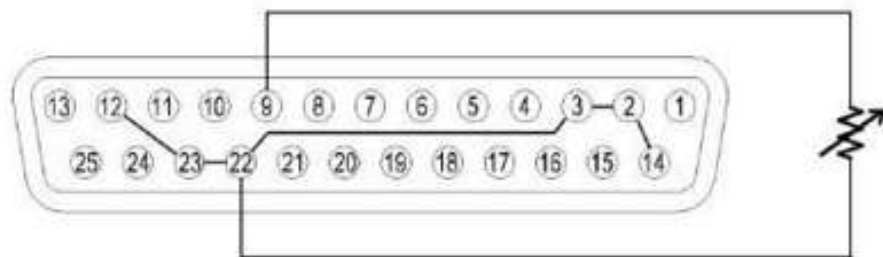

Figure 3.6 Voltage Mode: 0-5 V or 0-10 V

Current Program

Under resistor mode, the user may control the full scale current output value by connecting a resistance value of 0-5 k Ω (0-5 V / 0-5 k Ω mode) or 0-10 k Ω (0-10 V / 0-10 k Ω mode) between Pin 10 and Pin 23 as shown below.

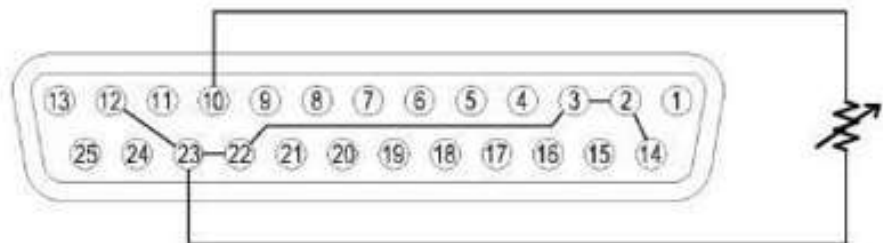

Figure 3.7 Resistance Mode Current Program: 0-5 V or 0-10 V

3.6.1 Voltage Monitor

This function is able to monitor the voltage output using Pin 11 and one of the ground pins (i.e. Pin 22), which can be connected to a digital voltage meter (DVM) or other voltage monitoring device, as shown below. The output control must be in analog mode to use this function. The monitoring of the output voltage range (which reflects 0 to full scale of the power supply's output voltage) can be selected between 0-5 V and 0-10 V.

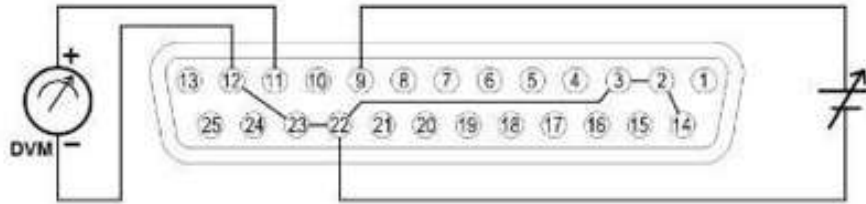

Figure 3.8 Voltage Monitor

3.6.2 Current Monitor

This function is able to monitor the voltage output using Pin 24 and one of the ground pins (i.e. Pin 23), which can be connected to a digital voltage meter (DVM) or other voltage monitoring device, as shown below. The output control must be in analog mode to use this function. The monitoring of the output voltage range (which reflects 0 to full scale of the power supply's output voltage) can be selected between 0-5 V and 0-10 V.

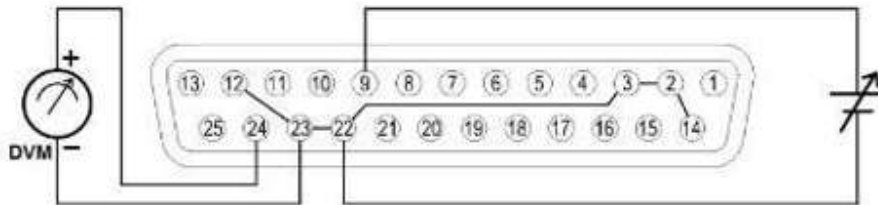

Figure 3.9 Current Monitor

3.6.3 Shut Off Control

Shut off control allows Pin 15 of the DB25 interface to be used to shut off the power supply's output, which is controlled by an input trigger signal.

When shut off occurs, the output will be turned off immediately and REMOTE INHIBIT ! will appear on the display as shown below. To enable the output again, first set (Pin 15) open.

Then, press **Esc** or sending the `OUTPut:PROTection:CLEar` command before pressing the **On/Off** button again to enable the output.





Note:

Shut off can only occur when the power supply receives a trigger. Maintaining that pin constantly open will not trigger a shut off.

3.7 Output (LED Mode)

The MR Series provide the LED mode, which enables them to function specifically for LED test applications. When this mode is ON (enabled), the power supply can operate in such a way as to minimize or almost eliminate the inrush current drawn by the LED load, which normally exists when the output switches from an OFF state to an ON state.

To enable LED mode, follow these steps:

1. From the normal display, press the  button to enter the menu.
2. Use the   keys to navigate to the **OUTPUT** submenu.
3. Press the  key to enter the **OUTPUT** submenu.
4. Use the rotary knob to enable **LED** mode.

Example

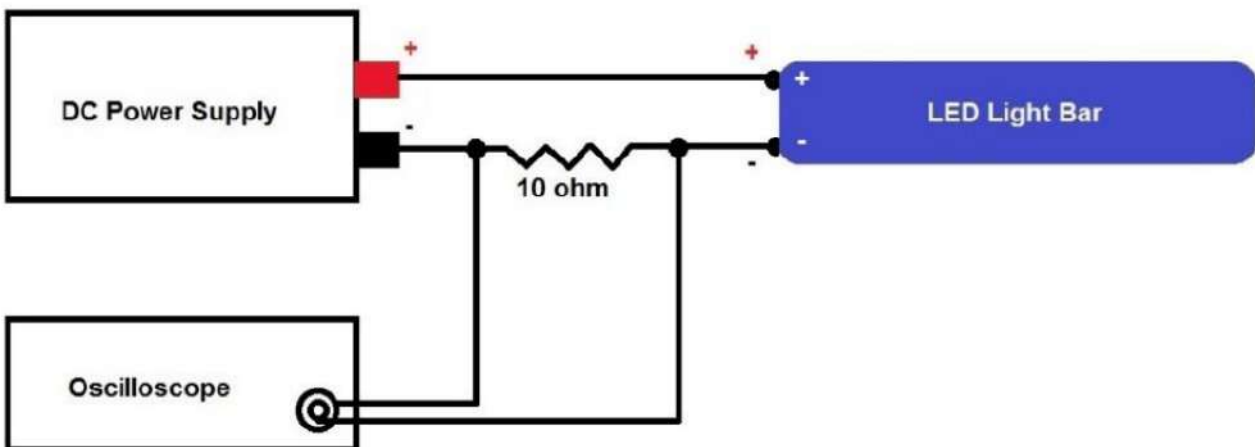

Figure 3.10 LED Testing Example

The MR output is initially OFF (disabled). The LED light bar is rated for 170 V. A $10\ \Omega$ resistor is placed in series with the LED light bar. The power supply current setting (ISET) is 20 mA. Using an oscilloscope to probe between the resistor to measure current, the power supply's output is then turned ON. The measured results are shown in [Figure 3.11](#), which compares the measured results with and without LED mode ON (enabled).

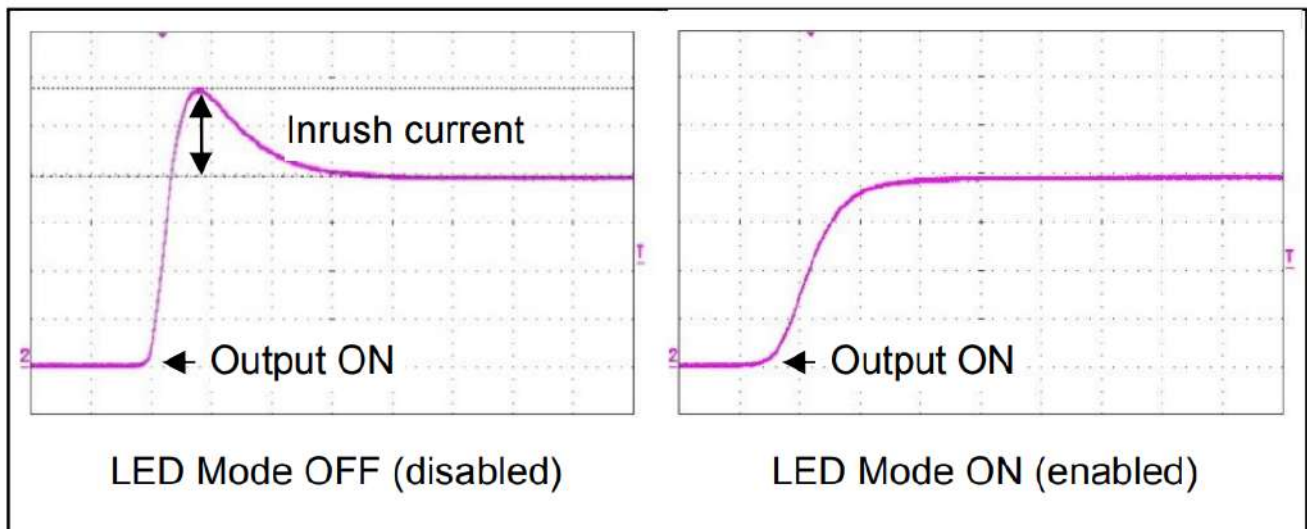

Figure 3.11 Inrush Current With and Without LED Mode Enabled

With LED mode ON (enabled), the power supply can minimize or eliminate any inrush current from turning the output ON, which in turn will minimize damage or life of the LEDs under test.

Note:

For LED mode to function correctly, the output must be turned OFF when connecting between the power supply and the LEDs under test. Turn ON the output after LED mode is enabled and all other settings are configured.

Parallel Operation

The MR power supplies can be connected in parallel to increase the power output capability as well as the output current. Up to *50 units of the same model can be connected for output up to 250 kW (max).

4.1 Connection and Setup

To connect multiple units in parallel, follow the diagram shown below:

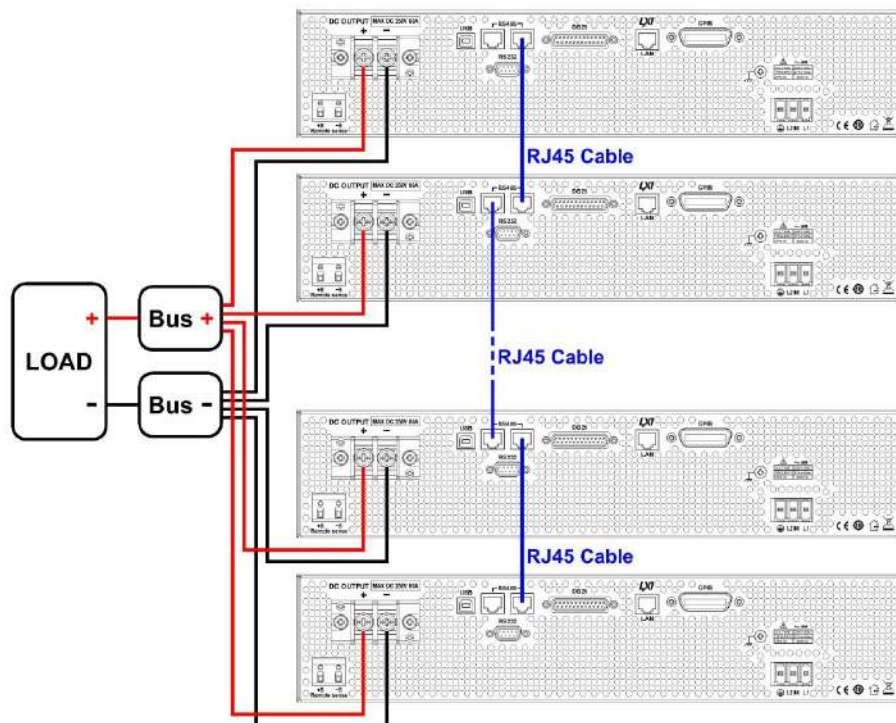









Figure 4.1 Connection and Setup

The power supplies must all be of the same model for parallel operation to function properly. If you want to connect more than 10 units in parallel, we recommend contacting us at bkprecision.com for further assistance.

After wiring is complete, configure one of the supplies as the Master and the other slaves (i.e. SLAVE 1 – SLAVE 49). After one of the supplies is configured to be the Master, it will start searching for all Slaves that are connected to the Master. To operate correctly, the user must set up the Slaves before the Master.

Follow the steps below to set a supply to master or slave mode (Note: Multi-unit connection (chain) mode will be cancelled).

1. Press the  button and press the  button one time until **PARALLEL** is select.
2. Press  to select the **Parallel Mode**.
3. Use the rotary knob to select the setting of OFF or ON and press .

4. Press the  button one time until **Address** is select and press  .
5. Use the rotary knob to set the master or slave and press  . Use the same procedure to set up MASTER, SLAVE 1, SLAVE 2,...,SLAVE 49 for the other power supplies.
6. Press  several times to exit the menu setting.

4.2 Slave Unit

When a power supply is set up to be a slave unit, it will wait for the master connection, as shown below.



If the master unit has found the slave unit, the slave unit will be controlled by the master unit and the following will be displayed:

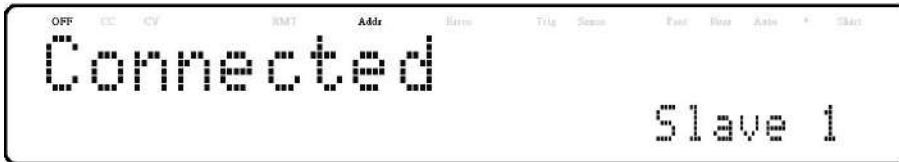

In parallel mode, the slave unit is remote controlled by the master unit. The keypad will be locked. To exit the parallel

Local



mode, press the  key to access the parallel mode ON/OFF setting in the menu. Turn off to disable parallel mode control.

4.3 Master Unit

After all of the slave units have been set, the master unit can be set by the same procedure with the role set to **MASTER**. As shown below, the master unit will start to search for the slave units.

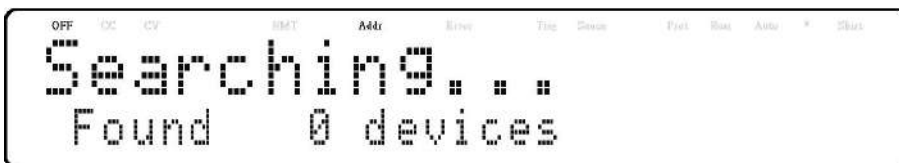

After the search, the master will show how many slave units have been found, as shown in the following display:

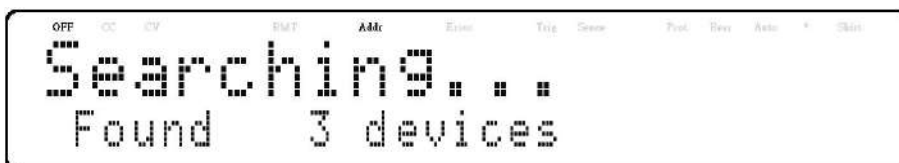

The search is completed will go into parallel mode operation. The following screen should be displayed.

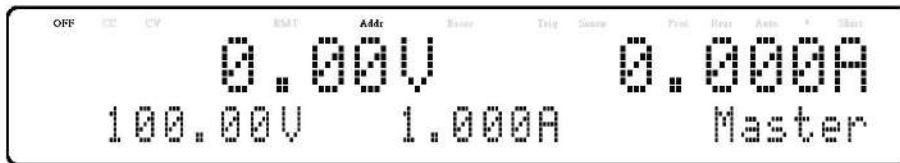

⚠ CAUTION

While in parallel connection mode, the output voltage of each power supply should be set to equal value. If the voltage value of each unit is not the same, the higher output voltage will feed back to the lower voltage unit and damage its internal components.

⚠ WARNING

DO NOT connect multiple power supplies in series as it will cause damage or malfunction.

⚠ CAUTION

When connecting in parallel mode, only the MASTER unit can be controlled by a computer for remote communication. There is also a decrease in speed and performance with each additional SLAVE units connected in parallel and linked together. The voltage and current scan speed, which affects synchronization between the supplies, between the slave units and the master unit will increase based on the following formula:

$$200 + 50 * (N-1) \text{ (in milliseconds)}$$

where N is the number of units in parallel. Please note as more units are paralleled and linked together, speed will become slower. Thus, we do not recommend paralleling too many units with this setup to ensure fast performance and operation. If the application requires connecting more than 10 units in parallel operation, we advise to contact us at bkprecision.com for further assistance.

PV Simulation

Typically, a solar array is connected to an inverter, which converts the panel's output from DC to AC. Due to varying environmental conditions and the nonlinear output of solar cells, many inverters use a maximum power point tracking mechanism to maximize the power generated from the solar panel. Using an actual solar array to test inverters is not cost-effective and environmental conditions are difficult to control in this scenario.

The MR power supply can simulate the output of a solar array with its solar array simulator (SAS) function. Combined with the SAS application software, users can simulate the I-V curve of different arrays under various irradiance conditions while measuring and validating the effectiveness of the inverter's MPPT algorithm.

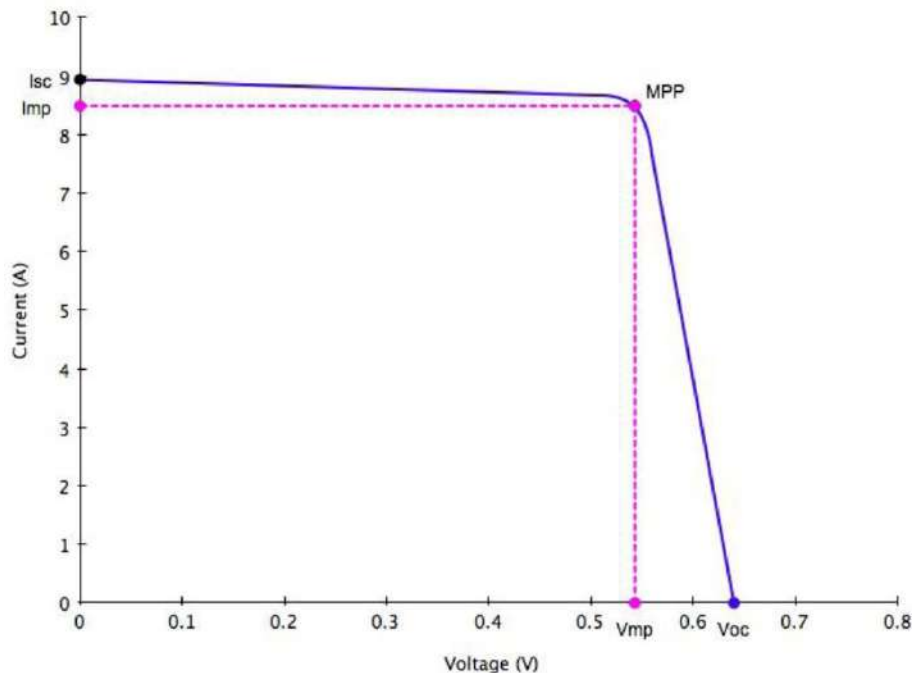

Figure 5.1 PV Simulation Curve

Solar arrays consist of multiple solar cells characterized by a complex voltage and current profile that is represented in an I-V curve. The I-V curve of a solar array can be generated automatically or manually using one of the following two methods:

- Automatically generate the I-V curves by specifying the type of regulation for testing, and the material types such as cSi and TF. The software supports testing against EN50530, SANDIA, and NB/T32004 regulation standards. Up to 101 sets of curve parameters can be created and downloaded to the MR supply's non-volatile memory or entered directly from the front panel. Based on these input parameters, the power supply will then automatically calculate the I-V profile.
- Manually generate the I-V curve by creating a user-defined table of points in the SAS software. Up to 4096 I-V points can be downloaded to the MR supply's non-volatile memory.





Once one of these I-V curves has been selected and set from the front panel, the power supply will operate in PV mode and output a voltage and current value according to the active I-V profile and load conditions. Different points on the I-V curve will be output in 1 ms intervals to test the inverter's MPPT efficiency. To create a user-defined table of I-V points and simulate a change in irradiance conditions (e.g. cloudy or rainy day), the PV supply must be controlled by

the SAS software. The SAS software also monitors and logs real-time voltage, current, and power as well as real-time and average MPPT efficiency to validate the inverter's MPPT algorithm.

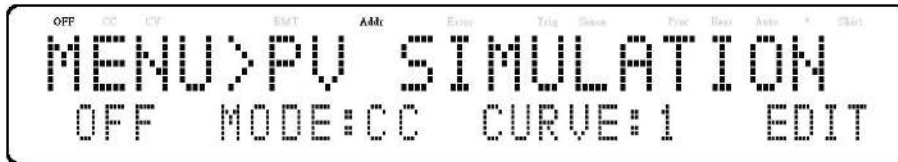

To configure and set the MR power supply to PV mode from the front panel, follow the steps below:

1. Press the **Menu** button and press the  button three times until **PV SIMULATION** is select, then press **Enter**. The following display will be shown:





2. Use the   keys to move the cursor to the ON/OFF field and use the rotary knob to select ON or OFF.
 - **ON**: MR supply is set to PV mode.
3. Use the   keys to move the cursor to the **CURVE** field and use the rotary knob to select the desired curve number.

The curve number can be **1-101** or **TABLE** (table of up to 4096 I-V points.)

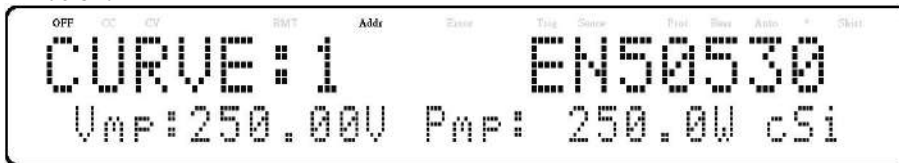



4. Once again, use the   keys to move the cursor to the **EDIT** field and press **Enter**. The following display will be shown:



5. Use the   keys to move the cursor through the four parameter settings. Use the numerical keys to enter parameter values and press **Enter** to confirm each of the four parameter settings.
6. Press **Esc** several times to exit the menu setting.

Power- On State

The initial Power-On state of the power supply can be configured (voltage, current, output state) by the following the steps below:

- From the menu, press the  button 3 times to select **POWER-ON STATE** and press  .
- The mode is showing on the display, press the  button. There are four options which can be selected using the rotary knob:
 - **DISABLE**: Last voltage and current values before power off and output state is OFF.
 - ***RST**: Reset output settings, voltage, current, output state, slew rate.
 - **LAST**: Last voltage, current, and output state values before power OFF.
 - **USER**: User defined voltage, current, and output state.
- Select one of the settings wanted during power up, and press  to save changes. If **USER** has been selected, set user defined memory and output state.
- Press  several times to exit the menu setting.

Communication Configuration

Select and setup the remote interface.

There are several interfaces available for remote communication: USB, RS232, GPIB, Ethernet, and RS485.

Users can program the power supply by using the SCPI (Standard Commands for Programmable Instruments) commands over any one of the remote interfaces. This section will describe how to set up all of the supported interfaces.

Note:

The RMT indicator will appear on display when the power supply is successfully connected to a PC remotely through any remote interface. Keys on the front panel will be locked until the instrument is in LOCAL mode. To return to

Local





LOCAL mode from the front panel, press . The RMT indicator will disappear when the instrument is in LOCAL mode.

7.1 USB

The MR series supports USBVCP and USBTMC.

To select either USBVCP or USBTMC:

- From the menu, select **Communication** and press .
- When USB is select, press  to select **USB**. The following display will be shown:



- Use the   keys to navigate between USBVCP and USBTMC. Press  to select an interface.

If USBTMC is chosen the following display will be shown:



7.1.1 USBVCP



The USBVCP is a virtual COM port that can be used for remote communication. There are no settings in the menu for USB configuration. To configure the USBVCP settings, refer to the RS232 settings below, as they are the same.

7.1.2 USBTMC





The USBTMC driver must be installed to use the USBTMC interface. The driver is included in the VISA software download and can also be found on our website. bkprecision.com (We recommend using NI-VISA, which can be downloaded at www.ni.com).

7.2 RS232

To configure the power supply for RS232 operation:

1. From the menu, select **Communication** and press  .
2. Press  button four times until RS232 is select.
3. Press  to configure the settings for RS232. The following display will be shown:



4. Use the   keys to select between each setting.
5. Press  to configure the corresponding settings.
 - To change the baud rate or any of the parameter settings, use the rotary knob.
 - Press  to save each setting.
 - Once the setting have saved the display will return to the RS232 menu.

The parameters available for each setting are listed below.

Baud rates: 9600, 19200, 38400, 57600

Note:

The default settings are 9600, None/8 bits, 1.

* The RS232 interface does not have flow control mechanism. The programmer should be aware of this limitation and notice the command process time of the power supply. If the remote commands are sent too fast to the power supply, the internal buffer may overrun and cause a communication error. Therefore, a delay between commands to let the power supply have enough time to process them is mandatory. All serial settings must match the settings configured on the PC in order for communication to link successfully.

7.3 GPIB

Each model can be configured with a GPIB address from 1-30. Follow the instructions below to select and configure the GPIB interface for remote operation.

- From the menu, select **Communication** and press **Enter**.
- When **GPIB** is select, press **Enter** to configure the settings for GPIB remote communication. The following display will be shown:



- Press **Enter** to configure the **GPIB Address** to which the power supply will be assigned to. Use the rotary dial or numeric keypad to enter a value from 1-30.
- Press **Enter** to save each setting and the display will return to the GPIB menu.
- Make sure the address assigned in the power supply unit matches the address the data commands are being sent to.

7.4 RS485

The MR series supports multiple power supplies (of the same model, up to *50) that can be connected together via RS485. The power supplies can be controlled with a computer via USB (virtual COM) interface (Chain mode). When connecting more than 10 units, add a 120Ω resistor terminator to the last unit as shown in the [figure](#) below. Follow the instructions below to select and configure the RS485 interface for remote operation.

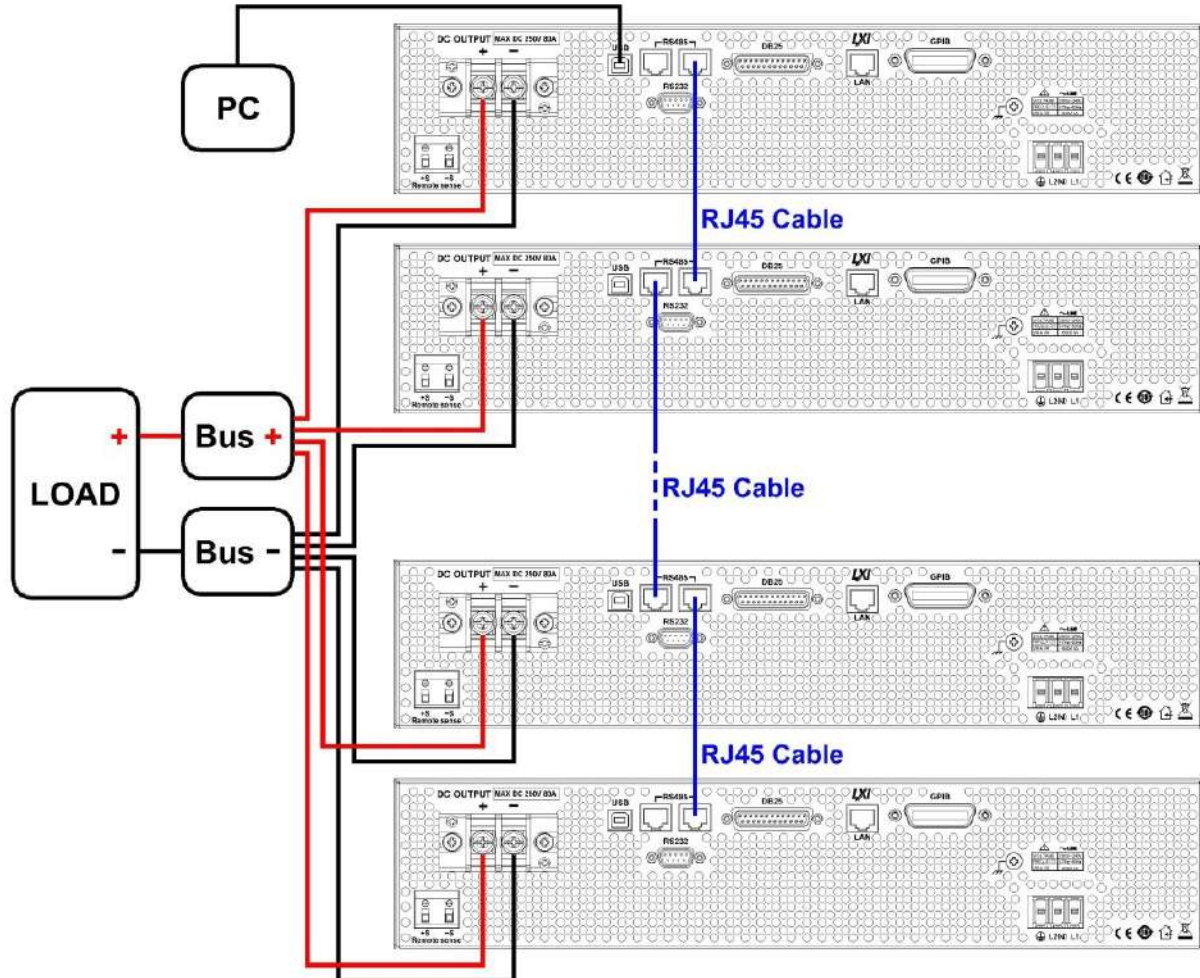
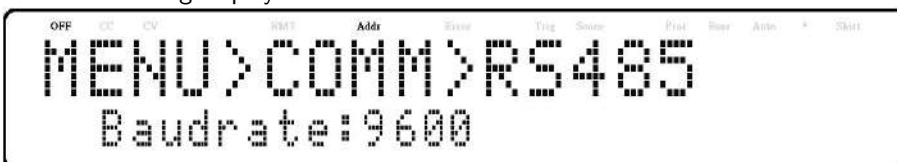

Figure 7.1 RS485 Connection Diagram

1. From the menu, browse and select **Communication** and press .
2. Press button two times until RS485 is select and press to configure the settings for RS485 remote communication. The following display will be shown:



3. Use the keys to select between each settings and press to configure the corresponding setting.
4. To change the parameter settings, use the rotary knob or the keys.
5. Press to save each setting and the display will return to the RS485 menu.

Below lists the options that can be changed for each setting:

Baud rate: 9600, 19200, 38400, 57600

Note:

The default is 9600, None/8 bits, 1, Address = 1, Off.

For each power supply that you want to control, provide a different address. For example, if you have three power supplies to control, set the first supply to address 1, second supply to address 2, and third supply to address 3. If two or more supplies have the same address, the RS485 protocols will create communication errors.

Repeat the above steps for each power supply that you want to connect together and control, making sure that each of them have a different address assigned.

To enable chain mode, return to the RS485 menu on any of the connected slave power supplies and set Chain to ON. The following display will be shown:



Slave number will change as more slaves are added

After enabling chain mode on all connected slaves, repeat the process to enable chain mode on the master (address = 1) power supply. The master will search and automatically connect to slave power supplies. Slave power supplies will display "Connected" if setup is successful.

Connect the USB of the first supply (address 1) to the computer, then use the Multi-Unit Programming commands to communicate with each power supply. Refer to "Multi-Unit Control Commands (Chain mode)" in the programming manual.



CAUTION

When connecting multiple power supplies (of the same model) in parallel while in chain mode, there will be a decrease in speed and performance with each additional units connected in parallel. The voltage and current scan speed, which affects the synchronization between the power supplies, between the slave units and the master unit will increase based on the following formula: $250 * N$ (in milliseconds) where N is the number of power supplies (of the same model) in parallel. Please note as more power supplies are paralleled and linked together, speed will become slower. Thus, we do not recommend paralleling more than 4 power supplies while in chain mode to ensure fast performance. Parallel mode is recommended when the application requires paralleling 5 to 10 power supplies. Refer to section 3.6 Parallel Operation for more details.

True RS485

The RS485 port is true RS485 mode by default allowing it to be used as an I/O interface for remote control and programming when parallel and chain mode are disabled.



The following table shows under what conditions true RS485 mode can be enabled:

Condition	True RS485 mode	Parallel mode	Chain mode
Factory default	ON	OFF	OFF
Parallel mode on	OFF	ON	ON
Chain mode on	OFF	OFF	ON
Parallel mode and Chain mode off	ON	OFF	OFF



Table 7.1 True RS485 Mode

7.5 LAN (Ethernet)

The LAN interface supports Static IP address and DHCP connection. The device has a built-in web server GUI. Follow the instructions below to select Ethernet interface for remote operation.

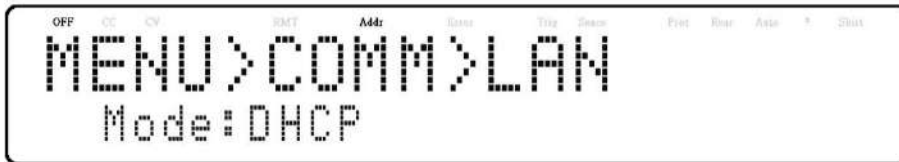
- From the menu, select Communication and press .
- Press  button two times until LAN is select.
- Press  to configure the settings for LAN remote communication. The following display will be shown:



- Use the  keys to select between each settings.
- Press  to configure the corresponding setting.
- To change any of the parameter settings, use the rotary knob.
- Press  to save each setting and the display will return to the LAN menu.

IP Mode



Select **Dynamic Host Configuration Protocol (DHCP)** or **Manual** to set how the LAN settings will be configured.

The easiest way to configure the LAN settings is to set the IP Mode to **DHCP.DHCP** will automatically assign an IP address to the instrument.

The settings can manually be configured by selecting **Manual**.

IP Address



The **IP Address** is a unique string of numbers separated by periods. To enter an IP address:

Use the numeric keypad to enter an IP address. Then  keys are used to separate each number in the string. After inputting each number press  to set the address.

Subnet Mask

Subnet Mask divides the IP address into network address and host address.

To set **Subnet Mask**:

Use the numeric keypad to enter the subnet mask. Then  keys are used to separate each number in the string. After inputting each number press  to set the address.

Gateway IP

The gateway address is by default the IP address of the network device that connects the instrument.

If **IP Mode** is set to DHCP **Gateway IP** does not have to be set.

To set **Gateway IP** :

Use the numeric keypad to enter an IP address. Then  keys are used to separate each number in the string. After inputting each number press  to set the address.

Primary DNS

Domain Name Service (DNS) is the system that automatically translates Internet addresses to the numeric machine addresses. The DNS address is the IP address of the system that performs this service.

If **IP Mode** is set to DHCP DNS will automatically be set.

To set the **Primary DNS** :

Use the numeric keypad to enter an IP address. Then  keys are used to separate each number in the string. After inputting each number press  to set the address.

7.5.1 Web Server

There is an embedded web server GUI that can access the power supply via LAN interface using a web browser. The GUI provides a simple way of setting voltage and current, as well as monitoring the output, using a web browser from a computer connected to the same local area network as the power supply.

To access the web server:

1. Connect the power supply to the same network as the PC.
2. Open a web browser on the computer to control the power supply.
3. Check the IP address of the power supply through INFO in the MENU.
4. Type the IP address of the power supply in the URL bar of your browser with http:// prefix (i.e. http://192.168.1.55 for IP Address 192.168.1.55).
5. If correctly configured, the screen will be shown Home page, and enter the Lan Config page, Config page, and Control page turn into Web Server Login Page, the following screen will be shown:



DC Source Web Login Page

Please enter password to continue

PASSWORD:

6. A password is required to login and access the menu items on the page. The default admin password **123456**.

Home Page

The HOME page provides general information of the power supply: LXI Device Model, Manufacturer, Serial Number, Description, LXI Version, mDNS Hostname, MAC address, TCP/IP address, Firmware Version, LXI Extended Function, LXI Device Address String, TCP/IP SOCKET Device Address String, USBTMC Device Address String, GPIB Device Address String, USB Port Function, RS232C setting, RS485 setting, Identification indicator function.

The screenshot displays the 'DC Source Web Control' interface. On the left is a blue navigation menu with links for Home, Lan Config, Config, Control, and Log In. The main content area is titled 'Home' and contains a table of device parameters. Below the table is a control for the 'Identification indicator' with radio buttons for 'ON' and 'OFF', and a 'SET' button. The footer indicates 'Copyright (c) BK Precision V1.00'.

LXI Device Model	MR100020
Manufacturer	BK Precision
Serial Number	40003WL1003
Description	BK Precision MR100020 DC Power Supply-40003WL1003
LXI Extended Functions	
LXI Version	1.5 LXI Device Specification 2016
mDNS Hostname	MR100020-L1003.local
MAC Address	00-17-F8-00-23-01
TCP IP Address	192.168.101.203
Firmware Version	1.03-1.01-1.H7-1.03
LXI Device Address String	TCP/IP-MR100020-L1003.local-inst0-INSTR
TCP IP SOCKET Device Address String	TCP/IP-MR100020-L1003.local-5025-SOCKET
USBTMC Device Address String	USB-0x3121-0x1000-40003WL1003-0-INSTR
GPIB Device Address String	GPIB-1-INSTR
USB Port Function	USBVCP
RS232C	9600
RS485	9600

Identification indicator ON OFF SET

Figure 7.2 Web Server Home Page

LAN Configuration

The LAN CONFIG page provides the Hostname, Description, IP Address, IP Address, Netmask, Gateway, DNS, password, Lan configuration, initialize, Restore Factory Settings.

DC Source Web Control	
LXI	
LAN Config	
Hostname	MR100020-L1003 <input type="button" value="Change"/> <input type="button" value="Unchange"/>
Description	BK Precision MR100020 DC Power Supply-40003/WL1003 <input type="button" value="Change"/> <input type="button" value="Unchange"/>
IP address configuration	<input checked="" type="radio"/> Automatic <input type="radio"/> Mannal <input type="button" value="Set"/>
IP Address	192.168.101.203 <input type="button" value="Change"/> <input type="button" value="Unchange"/>
Netmask	255.255.255.0 <input type="button" value="Change"/> <input type="button" value="Unchange"/>
Gateway	192.168.101.254 <input type="button" value="Change"/> <input type="button" value="Unchange"/>
DNS	192.168.100.5 <input type="button" value="Change"/> <input type="button" value="Unchange"/>
Password	123456 <input type="button" value="Change"/> <input type="button" value="Unchange"/>
LAN Configuration	<input type="button" value="Set"/>
Initialize	
Restore Factory Settings	<input type="button" value="Set"/>
Copyright (c) BK Precision V1.00	

Figure 7.3 LAN Configuration

Parameter Configuration

The CONFIG page provides the protection settings (OVP, OCP, OPP, CV to CC, and CC to CV) and output related parameters such as voltage/current slope and limit settings.

DC Source Web Control

Config

Protection

OVP ON OFF Value: 1100.0 V

OCP ON OFF Value: 22.000 A

OPP ON OFF Value: 5200.5 W

CV to CC ON OFF

CC to CV ON OFF

SET

Parameters

Voltage Slope Value: 15.685 V/mS

Current Slope Value: 500.0 mA/mS

VMAX Value: 1020.0 V

VMIN Value: 0.0 V

IMAX Value: 20.400 A

IMIN Value: 0.000 A

SET

Copyright (c) BK Precision V1.00

Figure 7.4 Parameters Configuration

Control Page

The CONTROL page provides the general control of the power supply such as output On/Off setting as well as the voltage and current setting. The command line for SCPI commands can also be accessed here.

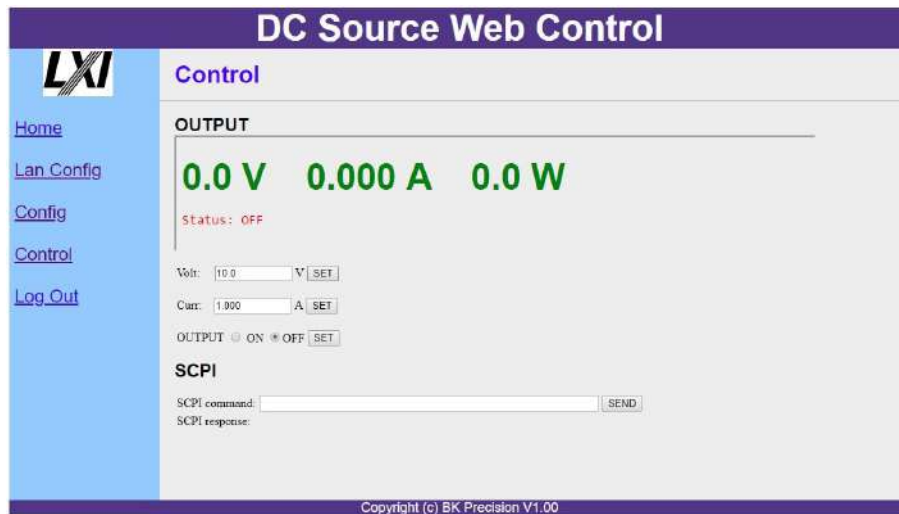

Figure 7.5 Control Page

Socket Connection

Socket connection is available for communication via LAN (Ethernet) interface. The instrument uses the TCP/IP protocol for communication. Users can use socket port **5025** to open a raw socket connection for sending remote commands.

7.6 Error/Event List

SCPI interface can offer an error/event list that contains up to 20 errors/events. Users can read the errors/events through the "SYStem:ERRor?" query command in a first-in first-out manner. Once an error/event is read, the read process will clear it from the memory. To clear all errors/events from the memory, the "*CLS" command can be used.

Error	Description
-000	No error
-102	Syntax error
-103	Invalid separator
-104	Data type error
-105	GET not allowed
-108	Parameter not allowed
-109	Missing Parameter
-110	Command header error
-111	Header separator error
-113	Undefined header
-131	Invalid suffix
-138	Suffix not allowed
-200	Execution error
-203	Command protected
-221	Settings conflict
-222	Data out of range
-223	Too much data
-240	Hardware error
-350	Error queue overflow

Table 7.2 Error/Event List

System Menu



All setup procedures and settings explained in this section can be accessed from the **SYSTEM** menu.

To access this menu, press  and press the  button five times until **SYSTEM** is displayed.

Press the  button to enter the menu.

8.1 Enable/Disable Key Sound

By default the key sound is enabled. To disable or re-enable the key sound:

- From the **SYSTEM** menu, select **BEEP** and press .
- Select between the two options using the rotary knob:
 - On : Enable key sound
 - Off : Disable key sound
- Select the desired option and press  to save the change.
- Press  several times to exit the menu setting.

8.2 Error Log

Errors are placed in the order that they were encountered. 1 being the most recent.

The error log displays up to 50 error codes.

After reaching 50 error codes no more codes will be reported in the error log.

To continue filing error codes the error log list must be cleared

To view the error codes:

- From the **System** menu, select **Error Code List**.

To clear the error codes:

1. From the **System** menu, select **Error Code Clear**.

```
OFF  CC  CV  RMT  Addr  Error  Trig  Sense  Prof  Rear  Auto  *  Skirt
MENU>SYS>ERROR LOG
< ERROR CODE CLEAR
```

2. Enter the default password: "13579" and press .



```
OFF  CC  CV  RMT  Addr  Error  Trig  Sense  Prof  Rear  Auto  *  Skirt
MENU>SYS>ERROR LOG
ENTER PASSWORD: *****
```

Error Code	Definition	Error Code	Definition
B001	Buck BUS Error	P001	PFC Over current
D001	Control board EEPROM Error	P002	PFC board no response
F001	AC Input Freq. Error	P003	PFC BUS low
H001	H/W OVP fail	P004	PFC BUS High
H002	H/W OCP fail	P005	PFC Relay OFF
M001	Module 1 voltage Error	R001	Remote sense reverse
M002	Module 2 voltage Error	R002	Remote sense open
M003	Module 3 voltage Error	R003	Remote sense fail
M004	Module 4 voltage Error	T001	Transformer of DC to DC over temperature
M101	Module 1 current Error	T002	MOSFET of buck over temperature
M102	Module 2 current Error	T003	MOSFET of Dummy Load over temperature
M103	Module 3 current Error	T004	PFC over temperature
M104	Module 4 current Error	V001	H/W high voltage
N001	FAN Error	V101	AC Input voltage too low
		V102	AC Input voltage too high

Table 8.1 Error Code List

8.3 Restore Factory Default Settings

To set all settings to factory default:

1. From the **SYSTEM** menu, press the  button 3 times to display **DEFAULT**.
2. Press  to select **DEFAULT**.
3. The instrument will return to the normal display and all settings will now restored back to factory default. (see table 8.2)

Item	Parameter	MR160120	MR3K160120	MR25080	MR50040	MR100020
Output	Voltage	10	10	10	10	10
	Current	1	1	1	1	1
	State	OFF	OFF	OFF	OFF	OFF
Protection	OVP Voltage	176	176	275	550	1100
	OCP Current	144	144	96	48	24
	OPP Power	5200.5	3120	5200.5	5200.5	5200.5
	CV to CC	OFF	OFF	OFF	OFF	OFF
	CC to CV	OFF	OFF	OFF	OFF	OFF
Limit	Vmax	163.2	163.2	255	510	1020
	Vmin	0	0	0	0	0
	I _{max}	122.4	122.4	81.6	40.8	20.4
	I _{min}	0	0	0	0	0
Slope	Voltage Slope	5.33	5.33	8.33	16.67	33.33
	Current Slope	1000	1000	1000	1000	1000
Beep	Mode	ON	ON	ON	ON	ON
Timer	Mode	OFF	OFF	OFF	OFF	OFF
	HHH:MM:SS	0:00:00	0:00:00	0:00:00	0:00:00	0:00:00
Program	Mode	OFF	OFF	OFF	OFF	OFF
	Program Number	0	0	0	0	0
Parallel	Mode	OFF	OFF	OFF	OFF	OFF
	Address	Master	Master	Master	Master	Master
PV Simulation	Mode	OFF	OFF	OFF	OFF	OFF
	Curve	1	1	1	1	1
	Control Mode	CC	CC	CC	CC	CC
External Control	Mode	EXT_V	EXT_V	EXT_V	EXT_V	EXT_V
	Range	10V/10K	10V/10K	10V/10K	10V/10K	10V/10K
	Shut Off	Live	Live	Live	Live	Live
Power-on State	Mode	Disable	Disable	Disable	Disable	Disable
	MEM	1	1	1	1	1
	Output State	Off	Off	Off	Off	Off
GPIB	Address	1	1	1	1	1
RS-232C	Baud	9600	9600	9600	9600	9600
RS-485	Baud	9600	9600	9600	9600	9600
LAN	Mode	DHCP	DHCP	DHCP	DHCP	DHCP
	IP address	0.0.0.0	0.0.0.0	0.0.0.0	0.0.0.0	0.0.0.0
	Mask address	0.0.0.0	0.0.0.0	0.0.0.0	0.0.0.0	0.0.0.0
	Gateway address	0.0.0.0	0.0.0.0	0.0.0.0	0.0.0.0	0.0.0.0
	DNS	8.8.8.8	8.8.8.8	8.8.8.8	8.8.8.8	8.8.8.8

Table 8.2 Factory Default Settings

8.4 Save/Recall Instrument Settings

The instrument can save up to 10 voltage/current values for quick recall.

8.4.1 Save Settings

1. Set up output voltage and current settings that you want to save.

2. Then, press **Shift** followed by **Recall**. The display will show the following:



3. Use the current adjust knob or the numeric keypad to enter the memory location in which to store current instrument settings. Select between 1 – 10. Press **Enter** to save to the selection location.

8.4.2 Recall Settings

1. Press **Recall** to enter **Recall** mode. The current group number will shown on the display.

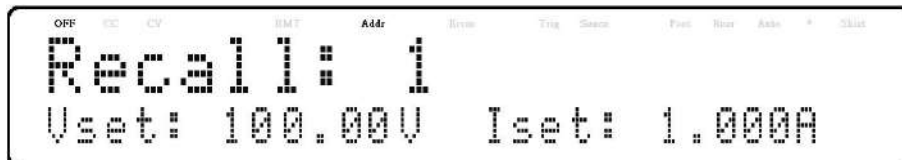

Instrument settings can only be recalled when the instrument enters this mode.

2. Use the keypad to enter the memory location you want to recall. Enter a value between 1 and 10. The voltage and current settings of that memory location will be shown on the bottom of the display.
3. Once entered, the saved settings at the location will be immediately recalled.

Note:

When in Recall mode, users can recall settings from different locations without having to press additional keys each time. For example, you can press 1 to recall settings in location one, and then press 5 to immediately recall settings in location 5.

8.5 Program Function

The MR has a Program feature that allows storing of programs into internal non-volatile memory and recalling and running them per configured parameters. A total of 100 steps can be configured for each program, and a total of 10 programs are available for storage. Additionally, multiple programs or all 10 programs can be saved into a program configuration, where each program configuration allows running one program after another or repeat a finite number of times. This allows for a total of 900 steps in single configuration. Figure 8.1 illustrates how programs are structured, stored, and recalled. Figure 8.2 shows an example of a program.

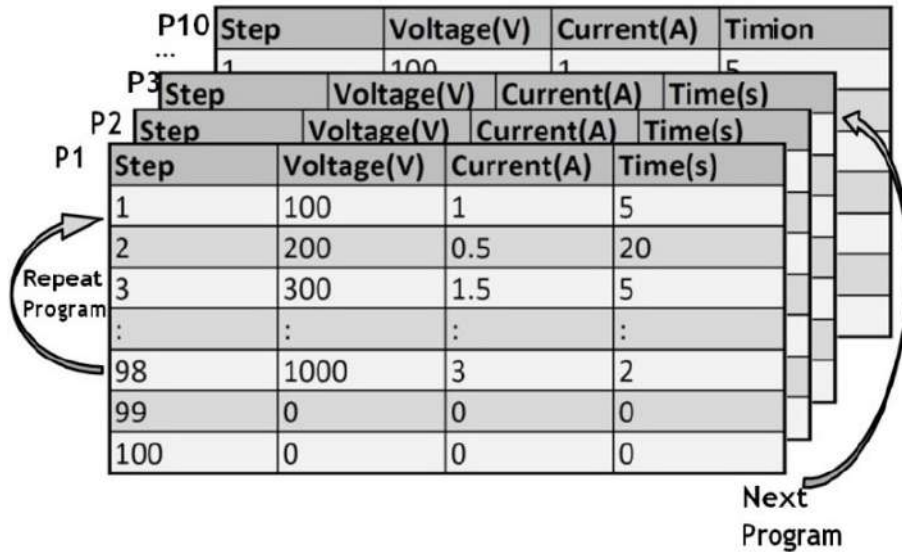

Figure 8.1 Program Structure Illustration

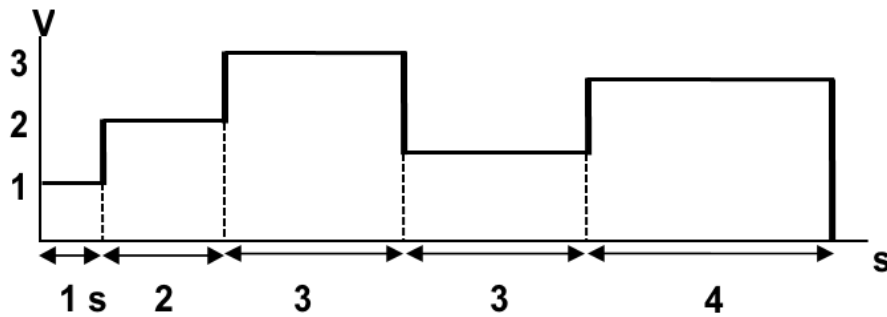

Figure 8.2 Program Example

8.5.1 Repeat and Next

Users also have the ability to utilize the **REPEAT** and **NEXT** options.

REPEAT

REPEAT allows the user to execute the same program as many times, continuously, as needed.

NEXT

NEXT allows the user to select the next program to be execute once the current program ends.

Note:





REPEAT and **NEXT** options are part of a program, so if one program's **NEXT** option is pointed to a previous program, the power supply will cycle these programs infinitely.

8.5.2 Setup a Program

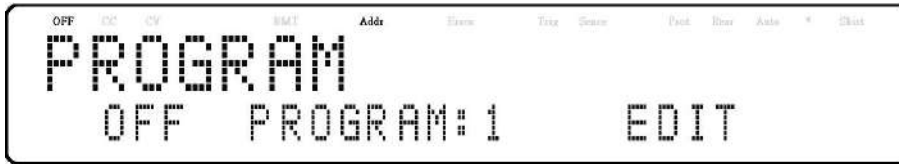



To setup a program:

1. Press the  button to enter the program function settings. The following will be displayed:

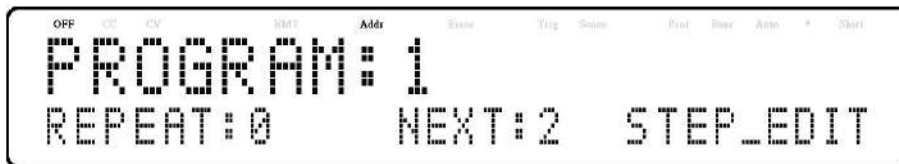



2. Use the rotary knob to select the setting of **OFF** or **ON**.
3. Use the   keys to move the cursor to the **PROGRAM** selection and use the rotary knob to select a program between 1-10.
4. Use the   keys to move the cursor to the **EDIT** selection and press . The following screen will be displayed:

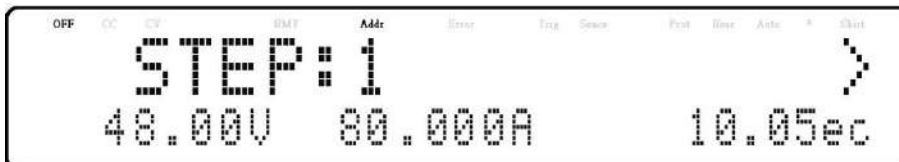

5. Press , at this point, the user may select how many times they wish the current program to repeat in the **REPEAT** field, by using the keypad or the rotary knob.
6. Press  to select **NEXT** parameter and use the rotary knob to select a value of 0-10.
 - As described previously, the user has the ability to queue another program once the current program is finished. By default, 0 is placed as the parameter value, and represent end the program.
7. Press  to select **STEP_EDIT** parameter, pressing  will be displayed:



Each step has the following parameters to be edited: voltage, current, and time.

- a. Press **Enter** to edit step, use the   keys to move the cursor to the desired parameter and use the rotary knob or keypad (numeric values only) to change the parameter values.
- b. Press **Enter** to complete the this step edit.
- c. Press  to edit next step, change the step value and continue this procedure for each step for as many steps as needed.
- d. Once all desired step have been set press **Esc** several times to complete the program configuration.

8. Make sure the program is turned ON and press **Esc** to exit the program settings.

9. Once the output state is enabled, by pressing **On/Off**, the program will automatically execute. The following will be displayed when the program is executing:

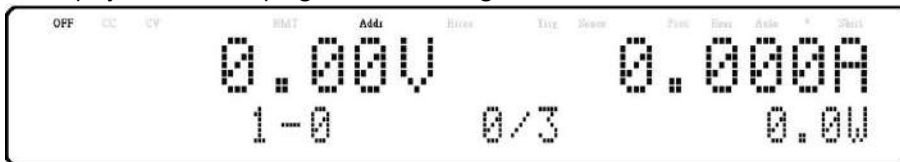

Where p is the program number, step (1-0 : 0) is the step number, repeat number (0/3 : 0) is the present repeated number and repeat number (0/3 : 3) is the total repeat number. For example, if the repeat number is 1/3, this means that there are three repeats of this program and it is now running the first repeat.

8.6 Timer



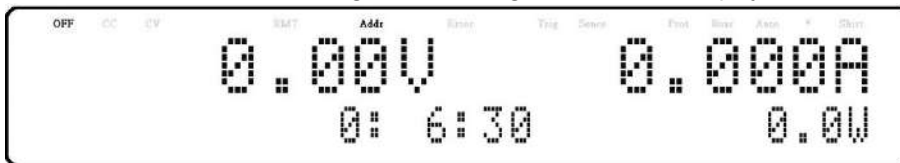

The timer function is a countdown clock, which allows the user to setup how long the output will be enabled when it is initially turned ON. When it is running, a clock on the display counts down until it reaches zero and the output will turn OFF. When the timer is running, the following screen will be displayed:

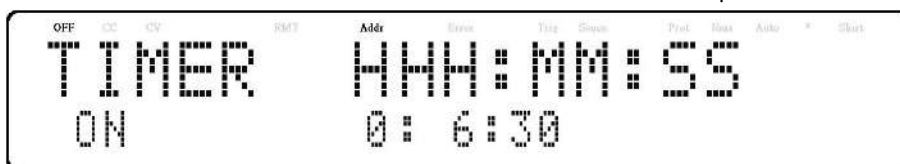

To activate the **Timer** function:

1. Press the **Shift** and **Iset** buttons to enter the timer setup screen. The following will be displayed:



2. Use the   keys to move the cursor to the desired parameter (hour, minute, and second) and use the keypad to change the parameter values.
3. Use the   keys to move the cursor to the ON/OFF parameter and use the rotary knob to change **ON** or **OFF**.

4. Press **Enter** to complete the timer setting.
5. Pressing the **On/Off** key will enable the output and start the timer.

8.7 Slew Rate

The power supply has the capability of controlling the output voltage and current slew rate. The timing can be configured for the rising/falling edge between voltage and current output transitions.

To configure the voltage or current slew rate:

1. Press **Shift** and **Slope Vset** buttons to enter the slope menu.
2. Use the **Left/Right** keys to select **VOLTAGE** or **CURRENT** and press **Enter** to confirm. The following will be displayed:

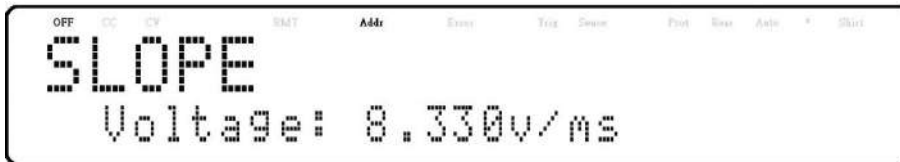

3. Use the keypad or rotary knob to enter the slope value and press **Enter** to confirm.
4. Press **Esc** to exit the slope menu.

Calibration





B&K Precision recommends a calibration interval of one year to ensure that the power supply meets specifications. This instrument features closed-case calibration. To perform the calibration, the following equipment is required:

- 6 ½ digit digital multimeter (DMM); B&K Precision 5493C or equivalent

WARNING

The following calibration instructions may be used by authorized technicians or calibration personnel only. If you are not authorized, do not attempt to calibrate the instrument yourself, as it may damage the instrument and void the warranty.

To enter the calibration procedure:

1. Press the  button.
2. Press the  button until **SYSTEM** is selected.
3. Press  to enter the **System Menu**.
4. Press the  the button until **CALIBRATION** is selected and press .

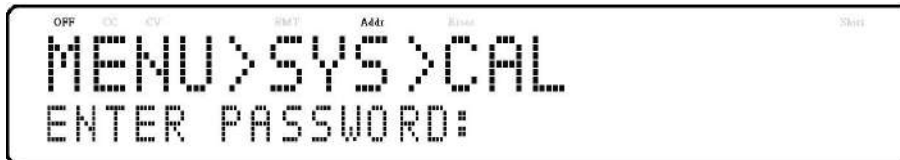

5. Enter the password **13579**, using the numeric keypad, and press the  key to confirm. The following display will be shown:

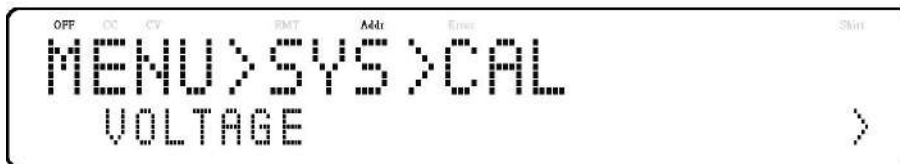

Calibration Options

- Output voltage
- Output current
- Overvoltage protection
- Overcurrent protection
- External voltage programming
- External current programming
- Constant current of external voltage programming
- Constant current of external current programming

These options are only accessible in the calibration menu. The following calibration procedures assume the operator is in the CAL menu.

9.1 Voltage Calibration

To perform a voltage calibration:

1. Connect the DMM to the output of the power supply as shown in the figure below:

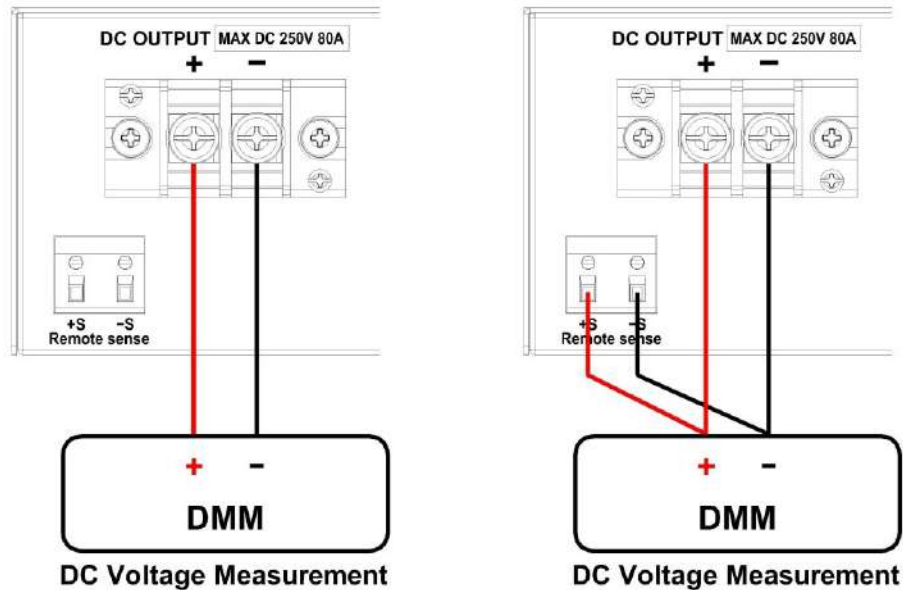

Figure 9.1 Voltage Calibration Diagram

When only calibrate local sense, connect the DMM to the output. When need to calibrate remote sense, connect the DMM to the output and remote sense.

2. Set the DMM to a DC voltage measurement. Select the VOLTAGE parameter in the **Calibration** menu and press

Enter

. The following will be displayed:

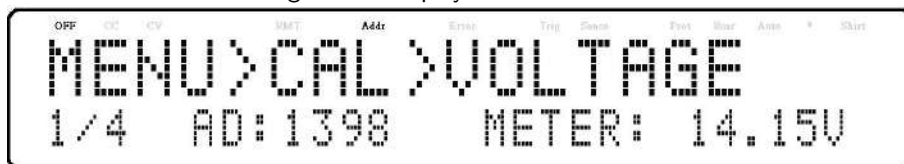

The 1/4 signifies there are 4 points to be calibrated, and the current calibration point is 1, and press **On/Off** to start calibration.

3. When **METER** parameter is blinking, input the voltage reading from the DMM in the **METER** parameter by using the numeric keypad and press **Enter**.
4. Repeat this procedure by entering the meter readings for points 2 – 4.

9.2 Current Calibration

To perform a current calibration:

- Connect the shunt resistance, DMM and Electronic load to the output of the power supply as shown in the figure below:

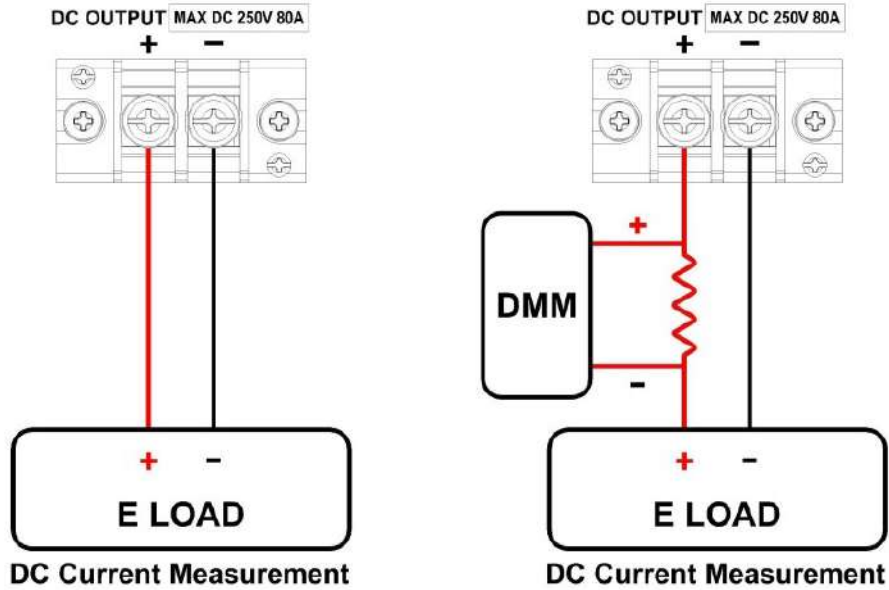
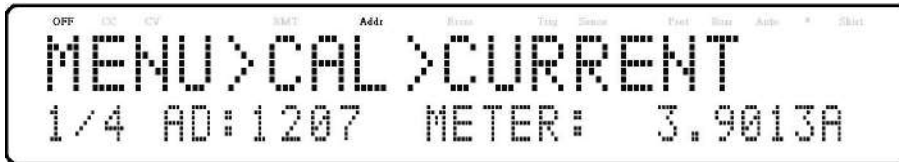

Figure 9.2 Current Calibration Diagram

- Set the DMM to a DC voltage measurement. Set the Electric Load in CV mode, the voltage set 5V. Select the **CURRENT** parameter in the **CALIBRATION** menu and press **Enter**. The following will be displayed:



The 1/4 signifies there are 4 points to be calibrated, and the current calibration point is 1, and press **On/Off** to start calibration.

- When **METER** parameter is blinking input the current, the voltage reading from the DMM divided by the shunt resistance, in the **METER** parameter by using the numeric keypad and pressing **Enter**.
- Repeat this procedure by entering the meter readings for points 2 – 4.

9.3 OVP Calibration

The overvoltage protection (OVP) calibration can be executed right after the voltage calibration or the user can select OVP in the Calibration menu.

To perform the overvoltage protection calibration:

1. Disconnect any load from the output terminal of the power supply.

2. Select the **OVP** parameter in the **CAL** menu and press **Enter**. The following will be displayed:

```
OFF  OC  CV  BMT  Addr  Error  Trip  Sense  Prot  Run  Auto  *  Shift
MENU>CAL>OVP
Press [ENTER] to start
```

3. Press the **Enter** to run the **OVP** calibration or press **Esc** to abort. The **OVP** calibration is an automatic process that will take about 10 to 20 seconds.

4. After the calibration is finished, the following message will be displayed:

```
OFF  OC  CV  BMT  Addr  Error  Trip  Sense  Prot  Run  Auto  *  Shift
MENU>CAL>OVP
Calibration...Success
```

9.4 OCP Calibration

The overcurrent protection (OCP) can be executed right after the current calibration or the user can select **OCP** in the **Calibration** menu.

To perform the voltage calibration:

1. Short the output + and - terminals of the power supply as shown below:

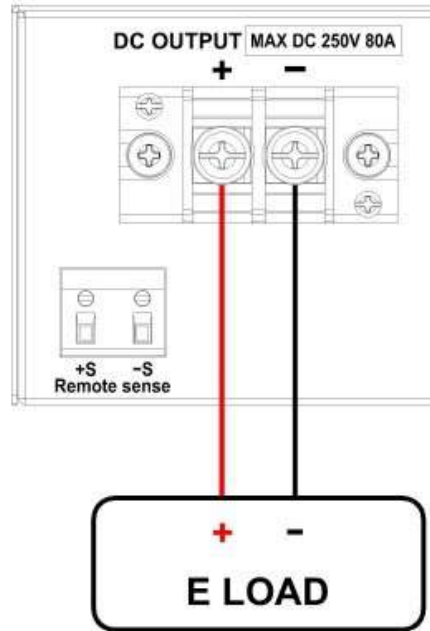

Figure 9.3 OCP Calibration Diagram

2. Set the Electric Load in CV mode, the voltage set 5V. Select the **OCP** parameter in the **CAL** menu and press **Enter**. The following will be displayed:

```

OFF  CC  CV  RMT  Addt  Error  Trig  Sense  Prot  Rec  Auto  *  Shift
MENU>CAL>OCP
Press [ENTER] to start
    
```

3. Press **Enter** to run the **OCP** calibration or press **Esc** to abort. The **OCP** calibration is an automatic process that will take about 20 to 30 seconds.

4. After the calibration is finished, the following message will be displayed:

```

OFF  CC  CV  RMT  Addt  Error  Trig  Sense  Prot  Rec  Auto  *  Shift
MENU>CAL>OCP
Calibration...Success
    
```

9.5 External Voltage Programming Calibration

To perform the external voltage programming calibration:

1. Connect the DMM to the external analog control terminals of DB25 connector (+ on the DMM to Pins 9 and 11, - on the DMM to Pin 22 (GND)) on the rear of the power supply, as shown in the figure below:

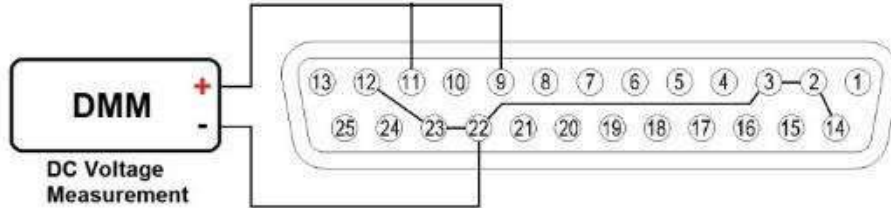
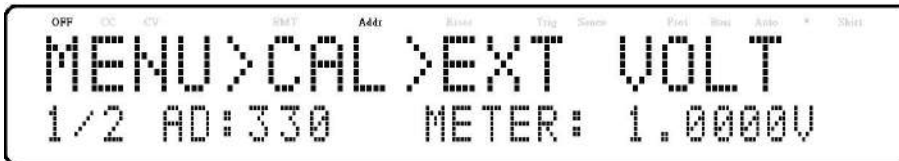

Figure 9.4 External Voltage Programming Calibration Diagram

2. Set the DMM to a DC voltage measurement. Select the **EXT_VOLT** parameter in the **Calibration** menu and press **Enter**. The following will be displayed:



The P: 1/2 signifies there are 2 points to be calibrated and the current calibration point is 1.

3. Input the voltage reading from the DMM in the **METER** parameter by using the numeric keypad and pressing **Enter**.
4. Repeat this procedure by entering the meter readings for points 2.

9.6 External Current Programming Calibration

To perform the external current programming calibration:

1. Connect the DMM to the external analog control terminals of DB25 connector (+ on the DMM to Pins 10 and 24, - on the DMM to Pin 22(GND)) on the rear of the power supply, as shown in the figure below:

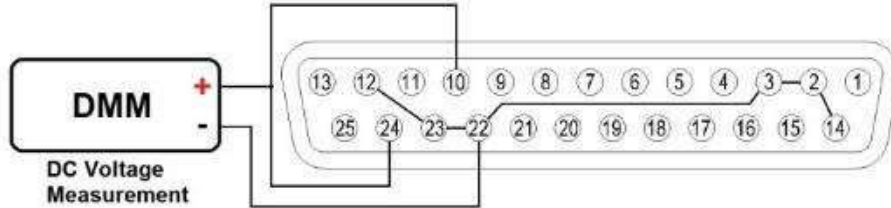
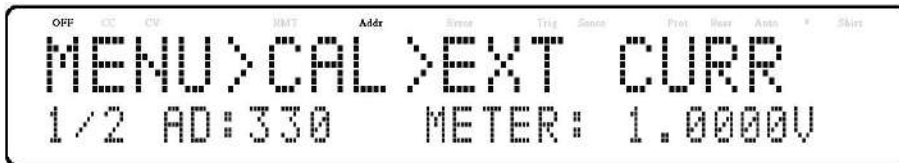

Figure 9.5 Current Programming Calibration Diagram

2. Set the DMM to a DC voltage measurement. Select the **EXT_CURR** parameter in the **CAL** menu and press **Enter**. The following will be displayed:



The P: 1/2 signifies there are 2 points to be calibrated and the current calibration point is 1.

3. Input the voltage reading from the DMM in the **METER** parameter by using the numeric keypad and press **Enter**.
4. Repeat this procedure by entering the meter readings for points 2.

9.7 CC Calibration of External Voltage

To perform the calibration procedure for the constant current source of the external voltage programming by resistor mode:

1. Connect the external analog control terminals of DB25 connector (Pins 9, 22(GND)) on the rear of the power supply, as shown in the figure below:

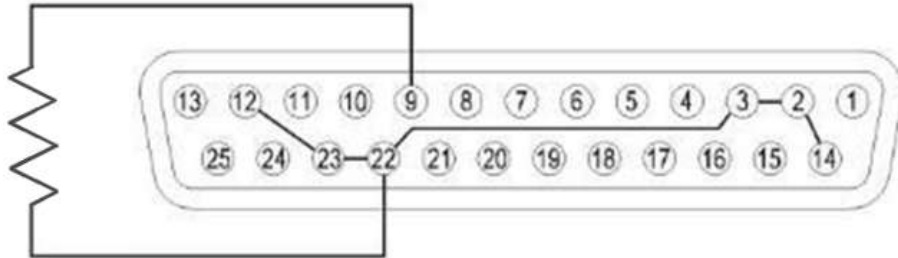

Figure 9.6 CC Calibration of External Voltage Diagram

2. Select the **EXT_V_CC** parameter in the Calibration menu and press **Enter**. The following will be displayed:

```

OFF  CC  CV  RMT  Addr  Range  Shift
MENU>SYS>CAL>EXTVCC
1/4 AD:8
    
```

The P: 1/4 signifies there are 4 points to be calibrated and the current calibration point is 1.

The four points use 0Ω, 2.5kΩ, 7.5kΩ, 10kΩ.

3. Press **On/Off**, the calibration will start, if the resistor is not insert or not correct, the following will be displayed:

```

OFF  CC  CV  RMT  Addr  Range  Shift
MENU>SYS>CAL>EXTVCC
1/4 AD:3901 Insert Resistor !
    
```

4. If the resistor is correct, the following will be displayed, press **Enter**.

```

OFF  CC  CV  RMT  Addr  Range  Shift
MENU>SYS>CAL>EXTVCC
1/4 AD:10      Press [ENTER]
    
```

5. Repeat this procedure by entering the meter readings for points 2 – 4.

9.8 CC Calibration of External Current

To perform the calibration procedure for the constant current source of the external current programming by resistor mode:

1. Connect the external analog control terminals of DB25 connector (Pins 10, Pin 22(GND)) on the rear of the power supply, as shown in the figure below:

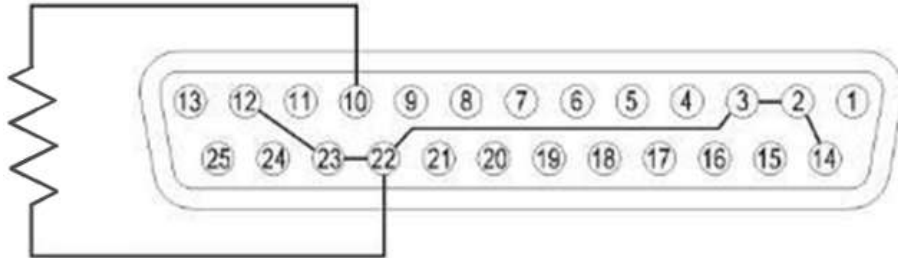

Figure 9.7 CC Calibration of External Current Diagram

2. Select the **EX_I_CC** parameter in the **Calibration** menu and press **Enter**. The following will be displayed:

```

OFF  CC  CV  BMT  Addr  Error  Start
MENU>SYS>CAL>EXTICC
1/4 AD:3901
    
```

The P: 1/4 signifies there are 4 points to be calibrated and the current calibration point is 1.

The four points use 0Ω, 2.5kΩ, 7.5kΩ, 10kΩ.

3. Press **On/Off**, the calibration will start, if the resistor is not inserted or not correct, the following will be displayed:

```

OFF  CC  CV  BMT  Addr  Error  Start
MENU>SYS>CAL>EXTICC
1/4 AD:3901 Insert Resistor !
    
```

4. If the resistor is correct, the following will be displayed, press **Enter**.

```

OFF  CC  CV  BMT  Addr  Error  Start
MENU>SYS>CAL>EXTICC
1/4 AD:10      Press [ENTER]
    
```

5. Repeat this procedure by entering the meter readings for points 2 – 4.

Specifications

Note: All specifications apply to the unit after a temperature stabilization time of 15 minutes over an ambient temperature range of 23 °C ± 5 °C. Specifications are valid for single unit operation only.

Model	MR3K160120	MR160120	MR25080	MR50040	MR100020	
Output Rating						
Output Voltage	0 to 160 V		0 to 250 V	0 to 500 V	0 to 1000 V	
Output Current	0 to 120 A		0 to 80 A	0 to 40 A	0 to 20 A	
Output Power	3000 W	5000 W				
Line Regulation						
Voltage	32 mV		15 mV	55 mV	80 mV	
Current	60 mA		20 mA	12 mA	10 mA	
Load Regulation						
Voltage	80 mV		120 mV	200 mV	250 mV	
Current	180 mA		50 mA	40 mA	25 mA	
Ripple and Noise (20 Hz to 20 MHz)						
Voltage p-p	120 mV	160 mV	500 mV	600 mV	700 mV	
Voltage rms	48 mV		85 mV	75 mV	120 mV	
Current rms ⁽¹⁾	120 mA	160 mA	20 mA	10 mA	5 mA	
Resolution						
Programming	10 mV / 7.5 mA		10 mV / 5 mA	20 mV / 2 mA	100 mV / 1 mA	
Readback	10 mV / 7.5 mA		10 mV / 5 mA	20 mV / 2 mA	100 mV / 1 mA	
Programming Accuracy						
Voltage	160 mV		100 mV	300 mV	500 mV	
Current	360 mA		60 mA	50 mA	25 mA	
Readback Accuracy						
Voltage	160 mV		250 mV	300 mV	500 mV	
Current	240 mA		60 mA	50 mA	25 mA	
Output Response Time⁽²⁾						
Rise Time	Full Load	≤ 30 ms		≤ 30 ms		
	No Load	≤ 30 ms		≤ 30 ms		
Fall Time	Full Load	≤ 80 ms	≤ 50 ms	≤ 55 ms	≤ 40 ms	≤ 50 ms
	No Load	≤ 10 s		≤ 8 s	≤ 10 s	≤ 10 s
Protection						
OVP	Range	0 to 176 V		0 to 275 V	0 to 550 V	0 to 1100 V
	Accuracy	1.6 V		2.5 V	5 V	10 V
OCP	Range	0 to 132 A		0 to 96 A	0 to 48 A	0 to 24 A
	Accuracy	1.2 A		0.8 A	0.4 A	0.2 A

(1) Current ripple is applied when output power > 1.0% of full power.

(2) From 10% to 90% or from 90% to 10% of total voltage excursion.

Model	MR3K160120	MR160120	MR25080	MR50040	MR100020
General					
Remote Sense Compensation	3.2 V		5 V	10 V	20 V
Transient Response Time ⁽³⁾	≤ 1.5 ms				
Command Response Time ⁽⁴⁾	10 ms				
Efficiency ⁽⁵⁾	≥ 80%	≥ 85%			
Power Factor	0.99				
I/O Interfaces	Analog (Galvanically isolated DB25), USB (USBTMC-compliant and virtual COM), RS232, GPIB, LAN (1.5 LXI device specification 2016)				
AC Line Input	200 to 240 VAC ± 10%, 47 Hz to 63 Hz				
AC Line Phase	Single phase				
Maximum Rated Input Power	4000 VA	6000 VA			
Temperature Ratings	Operation	32 °F to 104 °F (0 °C to 40 °C)			
	Storage	14 °F to 158 °F (-10 °C to 70 °C)			
Temperature Coefficient	Voltage	32 mV / °C	50 mV / °C	100 mV / °C	200 mV / °C
	Current	48 mA / °C	32 mA / °C	16 mA / °C	8 mA / °C
Dimensions (W×H×D)	16.5" x 3.5" x 21" (420 x 88 x 532 mm)				
Weight	38.6 lbs (17.5 kg)				
Warranty	3 Years				
Standard Accessories	Power cord, test report & certificate of calibration				
Optional Accessories	Rack mount kit (RKPVS)				

Regulatory Compliance	
Safety	Low Voltage Directive (LVD) 2014/35/EU, EN61010-1:2010, cTUVus certification mark ⁽⁶⁾ fulfills US (UL 61010-1:2012) and Canadian (CAN/CSA-C22.2 NO. 61010-1-12) safety standards
Electromagnetic Compatibility	EMC Directive 2014/30/EU, EN61326-1:2013

(3) Time for output voltage to recover within 1% of its rated output voltage for a load change 50-100% of rated output current.

(4) Typical time required for output to begin to change following receipt of command data.

(5) At nominal line and maximum load.

(6) Tested and certified by a Nationally Recognized Testing Laboratory (NRTL), accredited by OSHA.

Ordering Information

MR Series Power Supplies

Model	Description
MR3K160120	160 V / 120 A, 3000 W
MR160120	160 V / 120 A, 5000 W
MR25080	250 V / 80 A, 5000 W
MR50040	500 V / 40 A, 5000 W
MR100020	1000 V / 20 A, 5000 W

Service Information

Warranty Service: Please go to the support and service section on our website at bkprecision.com to obtain an RMA #. Return the product in the original packaging with proof of purchase to the address below. Clearly state on the RMA the performance problem and return any leads, probes, connectors and accessories that you are using with the device.

Non-Warranty Service: Please go to the support and service section on our website at bkprecision.com to obtain an RMA #. Return the product in the original packaging to the address below. Clearly state on the RMA the performance problem and return any leads, probes, connectors and accessories that you are using with the device. Customers not on an open account must include payment in the form of a money order or credit card. For the most current repair charges please refer to the service and support section on our website.

Return all merchandise to B&K Precision Corp. with prepaid shipping. The flat-rate repair charge for Non-Warranty Service does not include return shipping. Return shipping to locations in North America is included for Warranty Service. For overnight shipments and non-North American shipping fees please contact B&K Precision Corp.

Include with the returned instrument your complete return shipping address, contact name, phone number and description of problem.

B&K Precision Corp.
22820 Savi Ranch Parkway
Yorba Linda, CA 92887
bkprecision.com
714-921-9095

LIMITED THREE-YEAR WARRANTY

B&K Precision Corp. warrants to the original purchaser that its products and the component parts thereof, will be free from defects in workmanship and materials for a period of **three years** from date of purchase.

B&K Precision Corp. will, without charge, repair or replace, at its option, defective product or component parts. Returned product must be accompanied by proof of the purchase date in the form of a sales receipt.

To help us better serve you, please complete the warranty registration for your new instrument via our website www.bk-precision.com

Exclusions: This warranty does not apply in the event of misuse or abuse of the product or as a result of unauthorized alterations or repairs. The warranty is void if the serial number is altered, defaced or removed.

B&K Precision Corp. shall not be liable for any consequential damages, including without limitation damages resulting from loss of use. Some states do not allow limitations of incidental or consequential damages. So the above limitation or exclusion may not apply to you.

This warranty gives you specific rights and you may have other rights, which vary from state-to-state.

B&K Precision Corp.
22820 Savi Ranch Parkway
Yorba Linda, CA 92887
www.bkprecision.com
714-921-9095