

RK2US Rack Mount Kit Instructions

The RK2US is designed for use with select B&K Precision models: 9140, 9141, 8542B, 8500/B, 8502/B, 8510/B, 891. This kit includes front panel mounting hardware for mounting in a standard 19-inch rack cabinet. The RK2US is capable of mounting one or two 2U half-rack instruments side-by-side. The shelf-like design offers additional structural support.

Warning

To avoid personal injury, do not assemble or install this rack-mount unless you are qualified to do so.

Dimensions



Figure 1: Front view

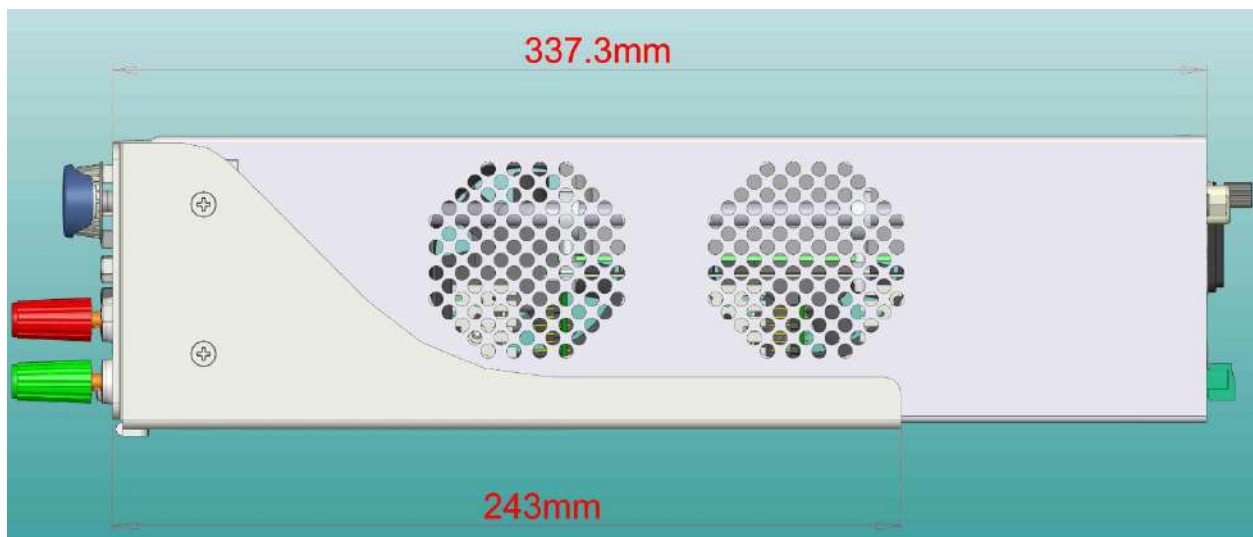

Figure 2: Side view

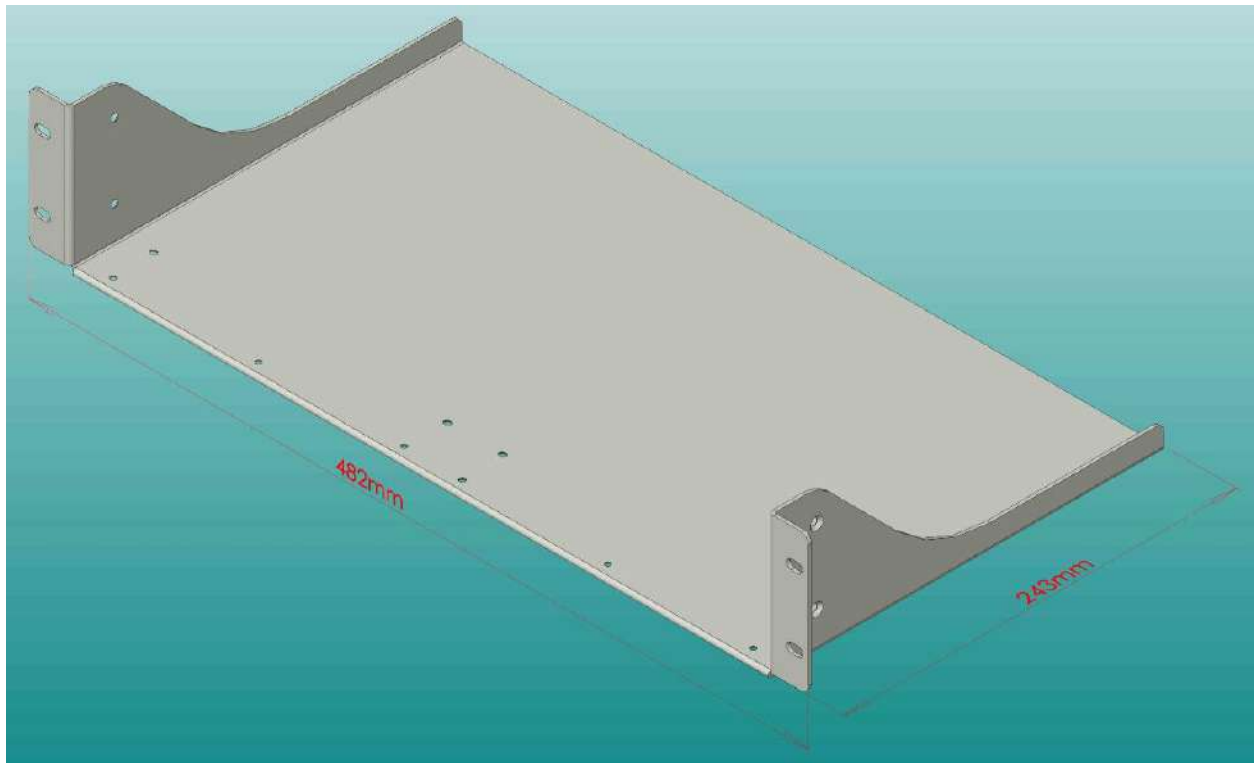

Figure 3: Angled view

Rack Mount the Instrument

Note: Remove the blue instrument bezels the carrying handle before mounting. The bezels are removed by gently sliding them off the end of the instrument. It is helpful to remove the front bezel first then stand the instrument vertically on the rear bezel to remove the handle. To remove the handle, grasp the handle by sides, pull outwards, and rotate until the notches in the handle align with the indentation (Fig. 4) on the side of the instrument.

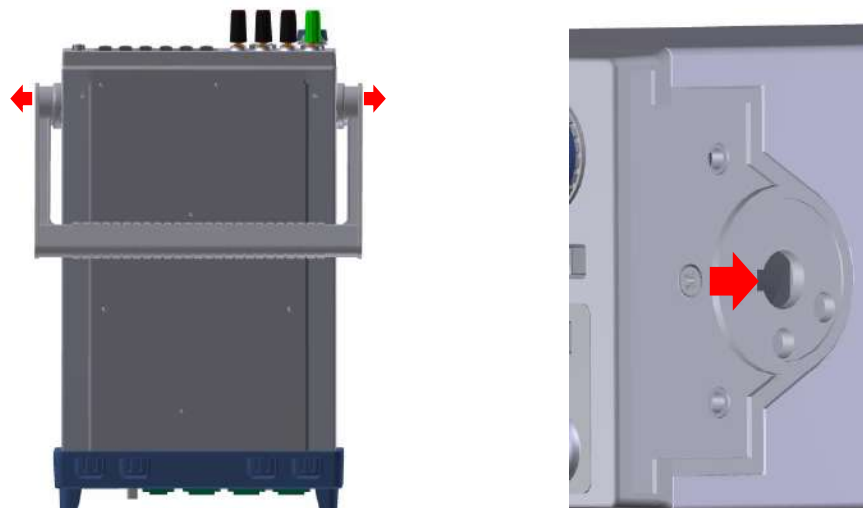

Figure 4:
Handle removal

Step 1. After removing the blue bezels and handle from the instrument locate the mounting points. Instruments can have 2 or 4 mounting points.

On the 9140 Series power supplies and 8500B Series DC Loads there are 4 mounting points in the locations shown in Fig. 5 below:

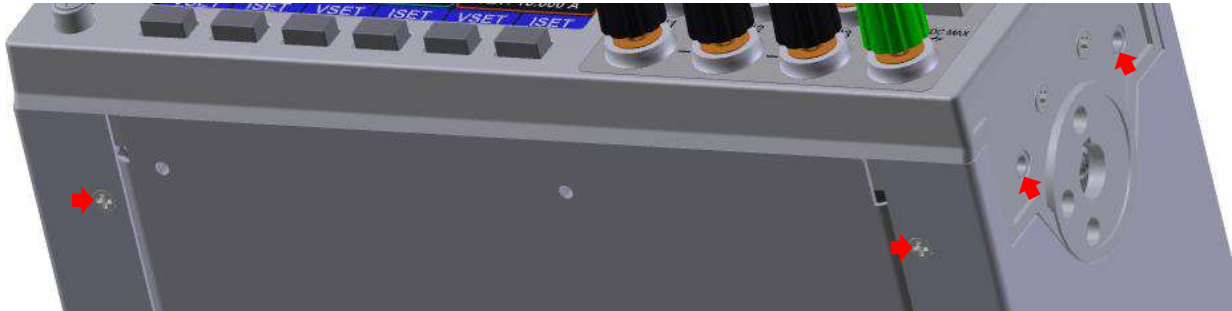

Figure 5: 9140 and 8500B mounting points

Note: The two screws on the bottom of the instrument must be removed before mounting.

Step 2. Place the instrument in the rack and align the mounting holes. A blank is provided for single instrument mounting (Fig. 6). The blank is held in place using 3 of the provided mounting screws through the bottom of the rack.

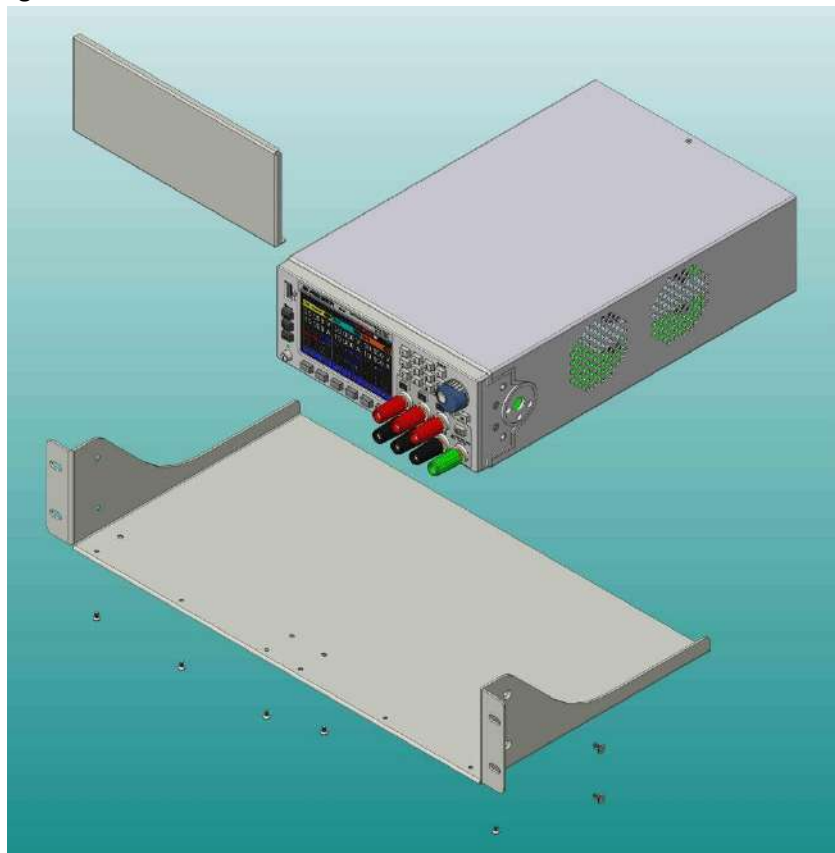

Figure 6: Single instrument mounting with blank

Step 3. Once the holes are aligned, fasten the two side screws using the provided hardware (Fig. 7). Then fasten the two bottom screws using the screws removed from the instrument in step 1 (Fig. 8). Do not tighten all of the screws until all of them are started and alignment has been checked.

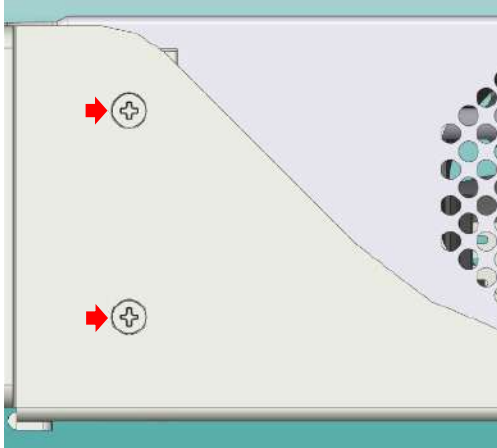

Figure 7: Side screws

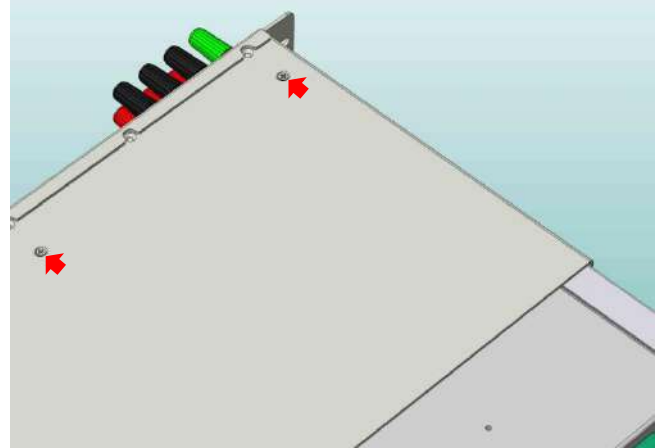

Figure 8: Bottom screws

Step 4. If necessary install the blank plate or repeat the process to mount two instruments side-by-side.

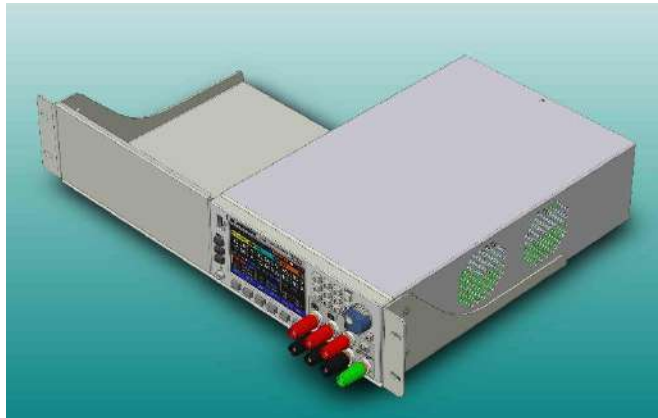

Figure 9: Single instrument with blank installed

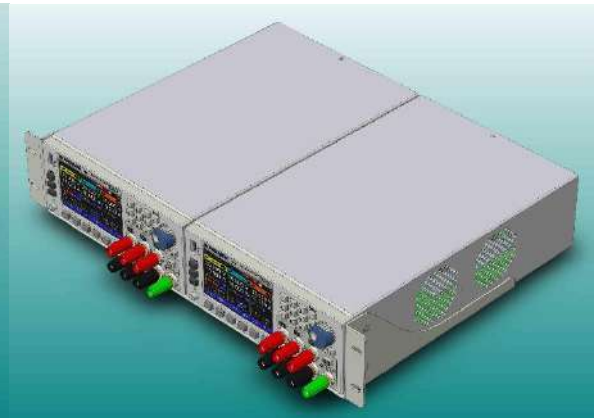

Figure 10: Two instruments mounted side-by-side

Thank you for using B&K Precision products if you have any other questions please contact technical support. <https://www.bkprecision.com/support/request.html?select=1>

BK PRECISION