

Products Information Vol.8

A-contents

Product and Technical Information



INDEX

● 8K Camera System	P4	● 4K / HD Production Studio, OB Van, Production	P24
● 8K Camera Lineup	P6	● Video Signal Generator	P26
● 8K Camcorder	P8	● Protocol Analyzer	P28
● BOSMA IP Camera	P9	● Test & Measurement	P30
● 8K Projector	P10	● HDMI 2.1 Signal Generator	P31
● High Performance Computing	P12	● System Integrating Processor	P32
● 22.2ch Sound System	P14	● MMT / TLV / MPEG-2 TS Solution	P34
● 8K Real-time MTF Measurement System / Display MTF Measurement System	P15	● 8K Services	P36
● 8K Recorder	P16	● Multipurpose Camera System	P38
● 8K Converter	P18	● New Laser Scanning Microscope	P39
● SMPTE ST 2110 Compliant IP Gateway	P20	● Web-based Virtual Museum / AI Scaler (ASTRO Intelligence Scaler)	P40
● Frame Memory Board Series	P21	● MADD.	P41
● 8K / 4K Monitor	P22	● Corporate Profile	P42
● Audio Monitor	P23	● INDEX (Product Lineup by Field / Model Number Index)	P43

8K Camera System

8K Camera System

With "8K eyes" you can not only see realistic image reproduction, but also details that are invisible to the naked eye, expanding our own human abilities.



8K 120Hz Portable Camera
AB-4815
▶ P7



8K Camcorder
AA-4814-B
▶ P8

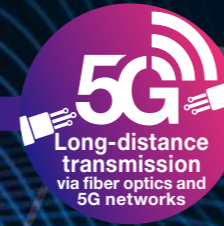

8K/Big Data



8K, to the Future Ahead

Sports Analysis

Digitizing and Visualising Sports

Higher accuracy analysis is possible by accumulating a large amount of detailed data. By doing so, it may be possible to greatly improve athlete performance, analysis competing teams data, improve video judgement technology, and more.



8K Video Server
SR-8428 / SR-8438 / SR-8450
▶ P17



Stadium

Indoor / Outdoor Large-scale Display

Provides an environment for large-scale display for entertainment, displaying video in the optimum size even if the display board differs from the video standard, as well as important text information that matched the video in quality



Multimedia Scan Converter
MC-2087
▶ P32



8K VR

8K VR

Using a VR system and an 8K camera solves the current lack of resolution in current HMD devices, as well as the complexity of shooting content at the same time.



8K Multi-Purpose Camera System
AB-4830
▶ P6

AI/Deep Learning

Big Data / AI High-definition 8K video for deep learning can be utilized in various industrial fields such as surveillance, medical care, and entertainment.



High Performance Computing
Tamazone Workstation
AW-8800
▶ P12



AI Upscaling

AI Upscaling It is now possible to achieve high-resolution upscaling of video through the use of AI.



AI Scaler (ASTRO Intelligence Scaler)
SP-2030
▶ P40

Public Viewing



DIGITAL PROJECTION
A Delta Associate Company

8K Projector
INSIGHT Laser 37000 8K
▶ P10, 11



ART



Web-based Virtual Museum
Hachikei Digital Art Cube
▶ P40



Virtual Museum

Medical



8K Multi-Purpose Camera System
AB-4830 / AC-4829
▶ P6

Security



Body Camera
ACW-P1000 / ACW-P2000

Digital Signal Generator

HDMI 2.1 DisplayPort



Digital Video Generator
VG-876 / VG-879
▶ P26, 27

ASTRODESIGN is Developing 8K Cameras Based on Uncompressed Real-time 8K Output. They Support Various Interfaces and Allow You to Share High-quality Video in an Instant.



HQX Workflow (120p / 100p)

Data Transfer

Equipment configuration for shooting at 8K 120p and 8K 100p



For 120p shooting and recording, connection with a U-SDI cable is necessary. When checking output such as for preview, video can be checked on a 4K or HD monitor by using a conversion device in the latter stages.

The transfer environment can be selected according to the situation.

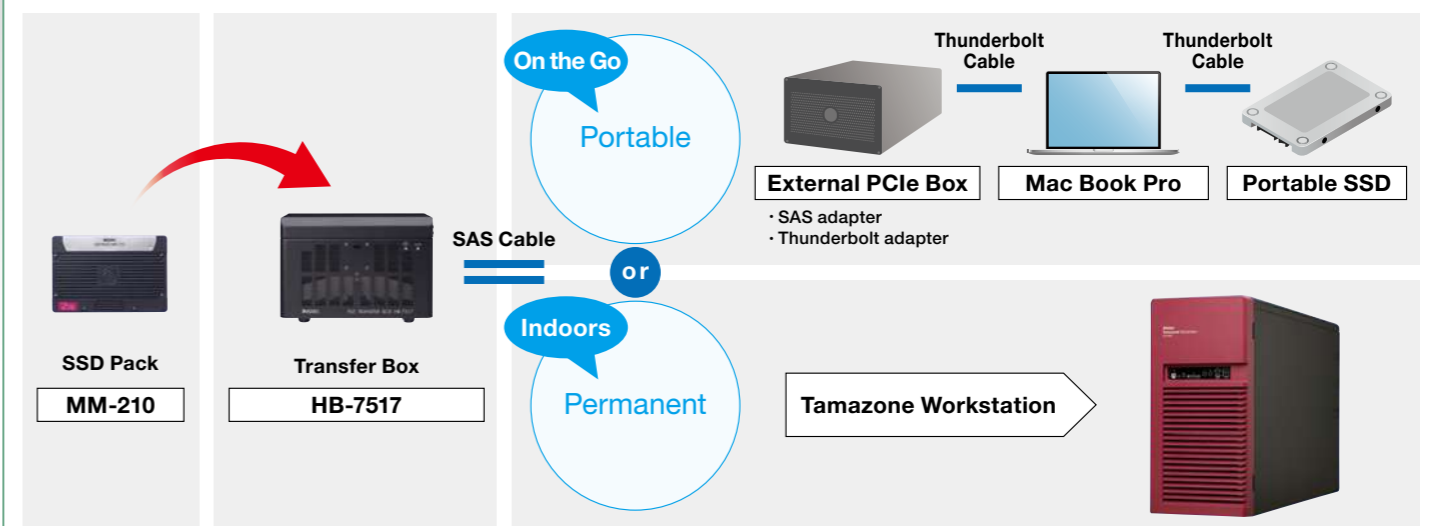

Video recorded to the SSD is transferred by connecting the transfer box to the PC with a SAS cable. When on site, video transfer can also be done with a laptop by using cable conversion.

8K Camera Use Case Examples

Slow Motion Video



Video shot in 120p enables smoother video expression. It can also be used for slow motion video.

Underwater Video



An underwater housing for the camcorder is also available for rent or purchase, allowing 8K to reach the depths of the ocean.

VR Shooting



Fisheye lens can be used to create 8K resolution VR video.

Performance Shooting



In cooperation with Botchan Theater

ASTRODESIGN will support systems that use 8K video technology, such as 8K shooting.

Support for 8K camera shooting is available.



AB-4830 / AC-4829 8K Multi-Purpose Camera System

This camera system is equipped with a global shutter. The camera head is designed not to need a fan so it can be reduced in size and weight. The camera head and CCU can be separated by a maximum of 100m. Can be used for remote monitoring and special installation environments.



AB-4831 8K 60Hz Portable Camera

This compact 8K camera is equipped with a global shutter. It can be used in many applications such as the real-time transmission of live events like theater and music.



Supports 100p / 120p

AB-4815 8K 120Hz Portable Camera

This portable 8K camera can output 120p / 100p video in real-time. This is one of ASTRODESIGN's flagship camera models.



CM-9010-B Multi-purpose Camera

This 8K camera system is divided between the camera head and the CCU. By using the CCU, you can record and output video at the same time.

Maker	ASTRODESIGN, Inc.	ASTRODESIGN, Inc.	ASTRODESIGN, Inc.	ASTRODESIGN, Inc.
Model Names	AB-4830 / AC-4829	AB-4831 Portable	AB-4815 Portable	CM-9010-B
Sensor	Super 35mm CMOS	Super 35mm CMOS	Super 35mm CMOS	Super 35mm CMOS
Shutter Format	Global Shutter	Global Shutter	Rolling Shutter	Rolling Shutter
Effective Pixels	7680 × 4320	7680 × 4320	7680 × 4320	7680 × 4320
Lens Mount	MFT	PL	PL	MFT
Dynamic Range	12 Stop	12 Stop	12 Stop	12 Stop
Gamma Curve	HLG, SDR, Log Gamma	HLG, SDR, Log Gamma	HLG, SDR, Log Gamma	HLG, SDR, Log Gamma
Color Gamut	ITU-R BT.2020 / ITU-R BT.709	ITU-R BT.2020 / ITU-R BT.709	ITU-R BT.2020 / ITU-R BT.709	ITU-R BT.2020 / ITU-R BT.709
Shutter	Shutter (1/60s-1/10000s)	Shutter (1/24s-1/10000s)	Shutter (1/24s-1/10000s)	Shutter (1/24s-1/10000s)
Frame Rate	60p / 59.94p / 50p	60p / 59.94p / 50p / 30p / 29.97p / 25p / 24p / 23.98p	120p / 119.98p / 100p 60p / 59.94p / 50p / 30p / 29.97p / 25p / 24p / 23.98p	60p / 59.94p / 50p / 30p / 29.97p / 25p / 24p / 23.98p
Audio	None	AUDIO IN XLR Type 3 pin (concave) × 2 (compatible with phantom power) MADI IN	AUDIO IN XLR Type 3 pin (concave) × 2 (compatible with phantom power) MADI IN	None
Output	8K: 12G-SDI × 4 4K: 12G-SDI / 3G-SDI × 4 2K: HD-SDI	8K 60p: 12G-SDI × 4 4K: 12G-SDI / 3G-SDI × 4 2K: HD-SDI	8K120p: 12G-SDI × 8 or U-SDI 8K 60p: 12G-SDI × 4 4K: 12G-SDI / 3G-SDI × 4 2K: HD-SDI	8K: 12G-SDI × 4 or 4K: 3G-SDI × 4 Monitor OUT HD-SDI
Recording	None	None	None	Grass Valley HQX Codec (7680 × 4320 4:2:2 10-bit)
Power Requirements	Camera Head: 8W CCU: 80W	70W	95W	118W
Dimensions	Camera Head: 65 (W) × 65 (H) × 88.5 (D)mm (Excluding Protrusions) CCU: 210 (W) × 133 (H) × 370 (D)mm (Excluding Protrusions)	148 (W) × 150 (H) × 241 (D) mm (Excluding Protrusions)	148 (W) × 150 (H) × 241 (D) mm (Excluding Protrusions)	Camera Head: 72 (W) × 75 (H) × 222.5 (D) mm (Excluding Protrusions) CCU: 170 (W) × 182 (H) × 250 (D) mm (Excluding Protrusions)
Weight	Camera Head: 340g CCU: 4Kg	Approx. 3.5kg	Approx. 3.5kg	Camera Head: 1kg CCU: 5kg

Options



DF-3516-A High-Definition Viewfinder

Viewfinder equipped with a Full-HD OLED display. It connects to AB-4831 and AB-4815 with a dedicated cable. It assists with focus and DR adjustment.



AT-4820 / AR-4821 Camera adaptor / Base station

A device that transmits 12G-SDI x 10 signal, power, and remote signal, etc. It transmits camera video to a remote location.



RB-4816-2 8K Camera Remote Controller

The remote to control the 8K camera. Can also be used to control some lenses.



HB-7517 Transfer Box

A device for transferring video from MM-210 to a PC using a SAS interface.



HR-7518-A 8K SSD Recorder

This 8K recorder supports 120p / 100p / 60p / 50p input. Also supports U-SDI and 12G-SDI.



MM-210 / MM-210-1 SSD Pack

This is an SSD pack used exclusively for our SSD recorders and CM-9010-B. Can record up to 40 minutes of 8K 60p footage on 2TB and up to 80 minutes on 4TB. The recording time is halved when using 120p.

8K Shooting, Recording, and Output with one 8K Camcorder

8K Camcorder [8C-B60A] [AA-4814-B]

AA-4814-B is an ASTRODESIGN customized model of Sharp's 8K camcorder, 8C-B60A. While preserving the basic functions such as shooting, recording, playback, and line output of 8K 60p video, we have improved the camcorder's usability and reflected the needs of the field.

Suitable for use in a variety of situations, such as high-quality video recording or live streaming with just one unit.



SHARP 8C-B60A 8K Camcorder

AA-4814-B 8K Camcorder

ASTRODESIGN, Inc. is the sole distributor of the 8C-B60A 8K Camcorder in Japan.

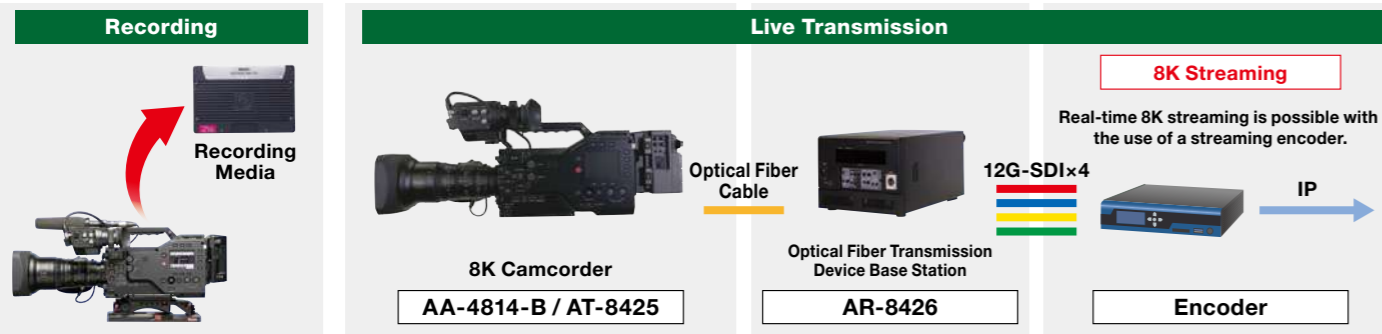

Maker	SHARP CORPORATION	ASTRODESIGN, Inc.
Model Names	8C-B60A Camcorder	AA-4814-B Camcorder (8C-B60A customization)
Sensor	Super 35mm CMOS	Super 35mm CMOS
Shutter Format	Rolling Shutter	Rolling Shutter
Effective Pixels	7680 x 4320	7680 x 4320
Lens Mount	PL	PL
Dynamic Range	12 Stop	12 Stop
Gamma Curve	HLG, SDR, Log Gamma	HLG, SDR, Log Gamma
Color Gamut	ITU-R BT.2020 / ITU-R BT.709	ITU-R BT.2020 / ITU-R BT.709
Shutter	Shutter (1/24s-1/10000s)	Shutter (1/24s-1/10000s)
Frame Rate	60p / 59.94p / 50p / 30p / 29.97p / 25p / 24p / 23.98p	60p / 59.94p / 50p / 30p / 29.97p / 25p / 24p / 23.98p
Audio	MIC IN XLR Type 5-pin (female) x 1 (phantom power supported) AUDIO IN XLR Type 3-pin (female) x 2 (phantom power supported) MADI IN	MIC IN XLR Type 5-pin (female) x 1 (phantom power supported) AUDIO IN XLR Type 3-pin (female) x 2 (phantom power supported) MADI IN
Storage	MM-210 / MM-210-1	MM-210 / MM-210-1
Output	8K: 12G-SDI x 4 or 4K: 3G-SDI x 4 Monitor OUT HD-SDI	8K: 12G-SDI x 4 or 4K: 3G-SDI x 4 Monitor OUT HD-SDI
Encode Method	Grass Valley HQX Codec (7680 x 4320 4:2:2 10-bit)	Grass Valley HQX Codec (7680 x 4320 4:2:2 10-bit)
Power Requirements	During Recording: 118W	During Recording: 118W
Dimensions	155 (W) x 188 (H) x 312 (D) mm (Excluding Protrusions)	162 (W) x 216 (H) x 311 (D) mm (Excluding Protrusions)
Weight	5kg	5kg

Peripheral Equipment



DF-3516-A
High-Definition Viewfinder

Viewfinder equipped with a Full-HD OLED display. Connects to the camcorder via a dedicated cable. It assists with focus and DR adjustment.



MM-210/MM-210-1
SSD Pack

Dedicated SSD pack for use with camcorder, etc. When recording in 8K 60p, 2TB can hold up to 40 minutes and 4TB can hold up to 80 minutes.



HB-7517
Transfer Box

A device for transferring video from MM-210 to a PC using a SAS interface.



AT-8425/AR-8426
Optical Fiber Transmission Device

A device that transmits 12G-SDI x 5 signal, power, and remote signal, etc. It transmits camera video to a remote location.

More Affordable than Conventional Products and Supports IP and HDMI Output. The First Step in Using 8K!

BOSMA G1 8K Streaming Camera [DC0200]



BOSMA

DC0200

Features

- Supports 8K 30p shooting with a 33 million pixel CMOS image sensor
- Equipped with HDMI 2.1 output for monitoring in 8K
- Supports 8K 30p real-time streaming via IP
- Supports video transmission protocols RTSP and SRT
- Remote control of lens with Micro Four Thirds lens mount
- Compact size
- Recording for long periods of time possible by external SSD connection or CFast2.0

Maker	Guangzhou BOSMA Corp.	Audio	3.5mm Plug 1 input, 1 output 5-pin LEMO (XLR) x 1 Equipped with Built-in Stereo Mic
Model Names	BOSMA G1 8K Streaming Camera	Storage	CFast 2.0 Card 1 slot
Sensor	4/3 Type 8K CMOS	Output	HDMI 2.1 (Up to 8K 30p) 1 output IP output (1GbE RJ-45 DHCP) 5GHz & 2.4GHz Wi-Fi Support
Shutter Format	Rolling Shutter	Encode Method	H.265 / H.264
Effective Pixels	7680 x 4320	Power Requirements	During Recording: 15W
Lens Mount	MFT	Dimensions	126 (W) x 108 (H) x 108.7 (D) mm (Excluding Protrusions)
Dynamic Range	11 Stop (SDR)	Weight	1.25kg
Gamma Curve	SDR10 / SDR8 / HDR10		
Color Gamut	ITU-R BT.2020 / ITU-R BT.709		
Shutter	Auto / Manual (1/30s-1/156250s)		
Frame Rate	8K 30p / 25p / 24p		

Compatible with Over 600-inch Screens, High Brightness 8K Projector

INSIGHT Laser 37000 8K [8K Projector]



A Delta Associate Company

37,000 lumens



Color System

3-Chip DLP® System Blue Laser+RED Laser

DMD Specification

3 × 1.38" DarkChip™ DMD™ Chip

Resolution / Aspect Ratio

8K (7680 × 4320)

Brightness

37,000 ISO lumens

Features

- Improved color reproducibility with addition of RED laser
- Stable operation for over 20,000 hours due to long-life laser light source
- Achieves stable operation due to water cooling system
- Supports up to 8K 120p
- Supports HDR (HLG / PQ)

Input and Output Interface

Signal	Connector	Quantity
HDMI 2.0	HDMI	4
DisplayPort 1.4	DisplayPort	2
12G-SDI	BNC	8
3G-SDI	BNC	16

Control System Interface

Signal	Connector	Number of Ports
LAN	RJ45	1
RS-232	9-Pin D-sub	1
Wired Control	3.5mm Stereo Jack	1
3D Sync	BNC	1

Dimensions : 750 (W) × 493 (H) × 1,130 (D) mm
(not including lens and main body handle)

Weight : 132kg

Compatible Lenses TR. 1.21-1.83:1
TR. 1.76-2.77:1
TR. 2.70-5.31:1

INSIGHT Laser 8K Imaging by ASTRO [8K Projector]



A Delta Associate Company

25,000 lumens



Color System

3-Chip DLP® System

DMD Specification

3 × 1.38" DarkChip™ DMD™ Chip

Resolution / Aspect Ratio

8K (7680 × 4320)

Brightness

25,000 ISO lumens

Features

- Light source: Blue laser + Yellow phosphor
- Stable operation for over 20,000 hours due to long-life laser light source
- Achieves stable operation due to water cooling system
- Supports up to 8K 120p
- Supports HDR (HLG / PQ)

Input and Output Interface

Signal	Connector	Quantity
12G-SDI	BNC	8
3G-SD	BNC	16

Control System Interface

Signal	Connector	Number of Ports
LAN	RJ45	1
RS-232	9-Pin D-sub	1

Dimensions : 703 (W) × 479 (H) × 1,000 (D) mm
(not including lens and main body handle)

Weight : 132kg

Compatible Lenses TR. 1.21-1.83:1
TR. 1.76-2.77:1
TR. 2.70-5.31:1

With the introduction of the INSIGHT Laser 37000 8K, the situations in which 8K projection can be used have been expanded even further. In addition to the conventional 12G-SDI × 4 input, because HDMI 2.0 × 4 and DisplayPort 1.4 × 2 input have been newly added, it can also support output from PCs, etc. without the use of a conversion device. It can be used for outdoor public viewing or events and signage, which have been extremely time-consuming to set up until now.

Digital Art

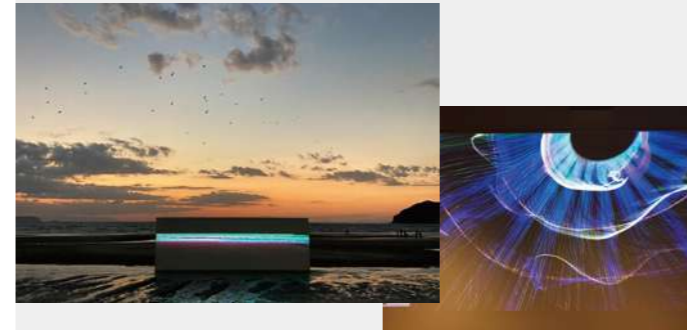

Produce a beautiful space by projecting digital art

Events



Produce a wide variety of diverse events with real-time CG synthesis

Live



Enjoy local events in other prefectures via long-distance transmission. Boost realism by projecting in 3D

VR

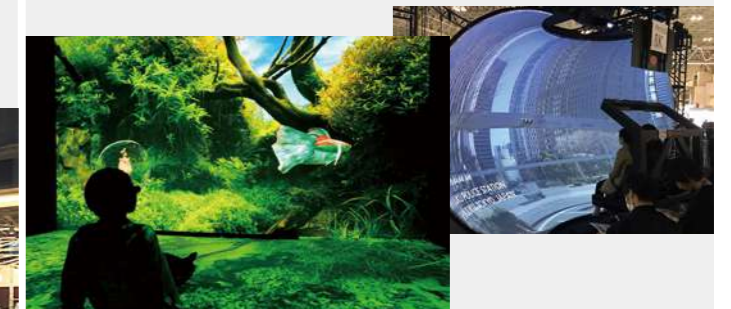

Experience VR without wearing a headset by projecting onto a large screen

Real-time Rendering Connection Example

Tamazone Workstation
For further details, see P12.

INSIGHT Laser 37000 8K



GPU: NVIDIA® RTX8000

DisplayPort × 2



In the case of 3D



GPU: NVIDIA® RTX8000
NVIDIA® P4000

DisplayPort × 2

3D Emitter

BB

3D Glasses



Multi-platform for Handling Heavy 8K Video

Tamazone Player

Tamazone Workstation [AW-8800]

8K H.265 Player [HP-7524]



Tamazone Workstation boasts high-performance CPUs and a large main memory which link together to enable high-speed processing, in addition to high-speed and large capacity storage comparable to that of a server. These features all combine to create the ultimate next-generation workstation.

- Maximum 56 CPU cores
- Maximum 6TB of main memory
- Installation of up to 4 PCI Express 3.0 double-width GPU cards
- Built-in storage with speed capable of reading / writing uncompressed 8K in real-time (max. 256TB)
- Large capacity, redundant power supply

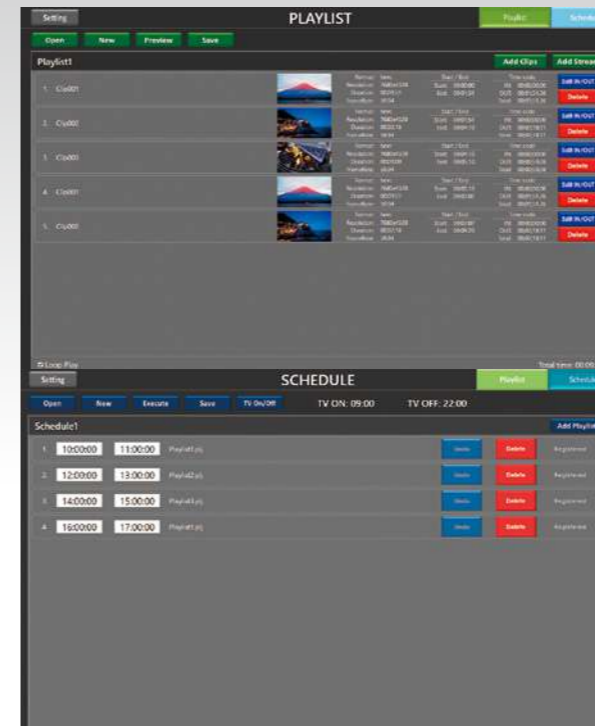

Tamazone Player is an 8K player that can playback HEVC files and supports HDMI 2.1 and DisplayPort 1.4, making it possible to create a high definition 8K content display system at a low cost by pairing it with 8K projectors or commercially available 8K monitors or TVs.

- Low cost, high definition 8K player
- Simple user interface
- Real-time decoding
- Real-time 8K streaming (RTP, HLS, etc.) playback

AW-8800

Front / Rear Diagram



Applications

Uncompressed 8K Real-time Recording

- Recording Function** ● Uncompressed 4K / 8K recording (YUV, 4:2:2, 59.94p)
- Playback Function** ● Uncompressed 4K / 8K recording (YUV, 4:2:2, 59.94p)
- Import / Export Function (File Exchange)** ● Import and export of DPX / TIFF files

8K Video Editing System

- Real-time 8K60p video editing
- Real-time 8K60p video color grading

Sequential Read / Write Function

Sequential Read / Write Speed	
Read	27.9GB/s
Write	27.7GB/s

Data Flow

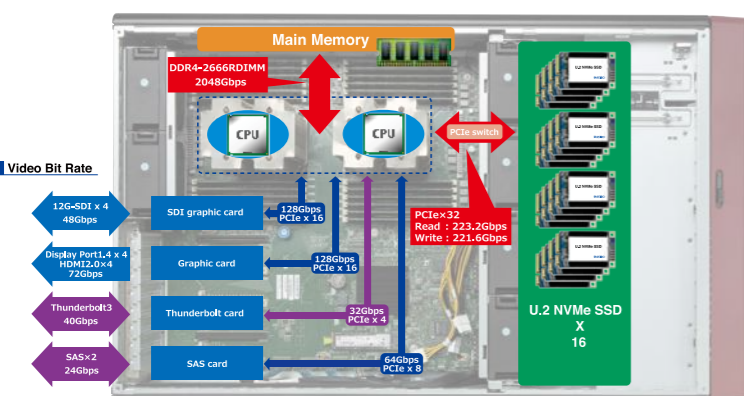

HP-7524

Solutions

- 8K Signage**
 - 8K signage environment creation using functions such as schedule playback and loop playback
 - Set up playlists and playback time controls with easy-to-use user interface
- Content Quality Check**
 - Ideal for quality check by playback of HEVC files as specified by the ARIB file exchange format standard (ARIB STD-B77)
- 8K Live Transmission**
 - Playback 8K streaming sent from remote locations in real-time for 8K broadcasts of events, etc.
 - Decode high-definition 8K video transmitted from a content server

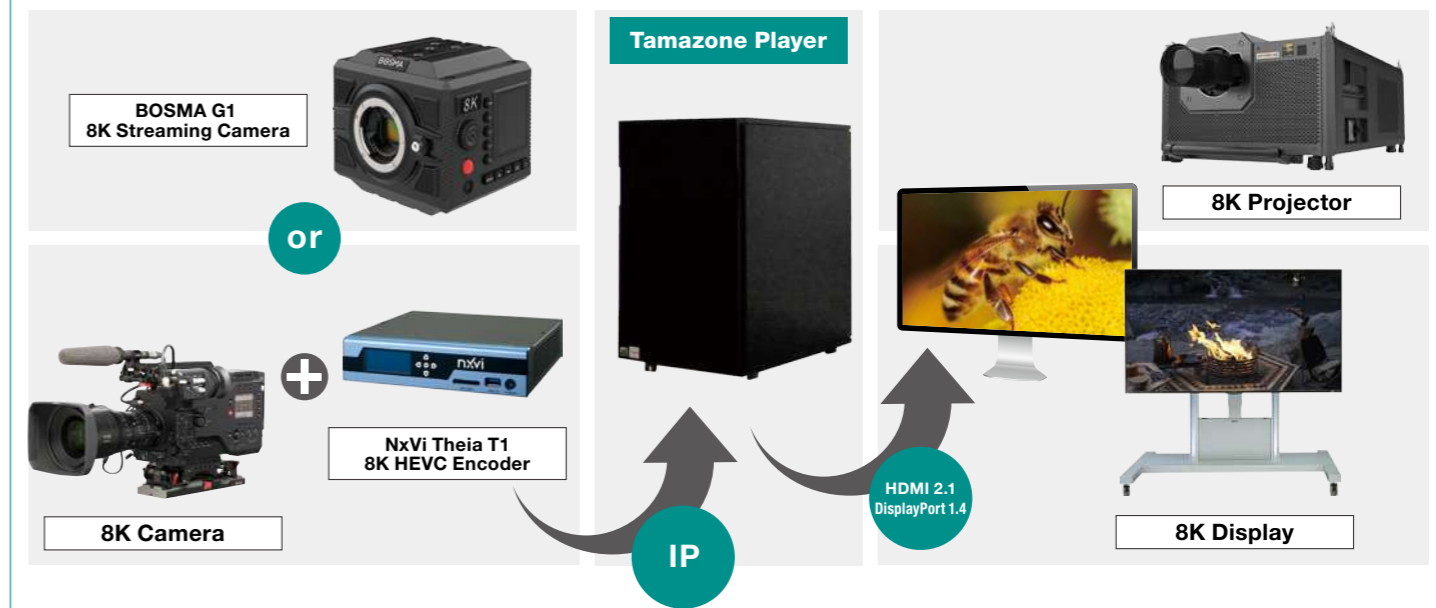

Decoder and Speaker Developed to Let Many People Experience 22.2ch

22.2ch Audio Decoder **【MA-1851】**

It is an audio decoder that supports MPEG-4 AAC audio input. You can build a 22.2ch sound system.



Features

- MPEG-4 AAC 22.2ch / 5.1ch / 2ch decoding possible
- Input audio mode automatic tracking
- Supports ARC / eARC input
- Supports HDMI (8ch) x 3 output and MAD1 (24ch) x 1 output
- Output audio delay function
- Input status and sound level meter display

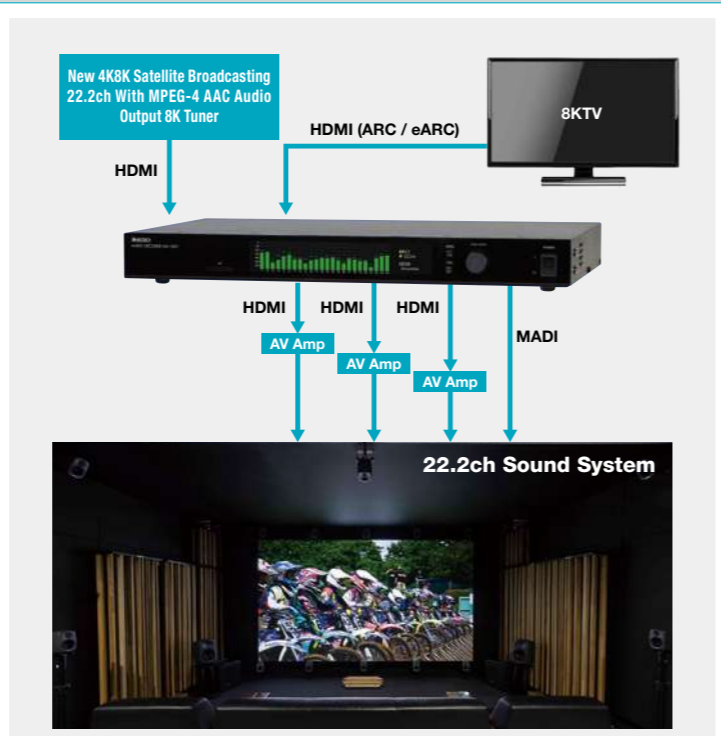

22.2ch Chair Style Speaker **【SA-1852】**



It is a chair type speaker that can be used to build a 22.2ch sound system in a small space. Twenty-four high-performance speakers are built into the soundproof hard shell and a 22.2ch sound field is realistically reproduced.

Along with an 8K large screen TV, you can fully enjoy 8K broadcasting while being surrounded by immersive sound.

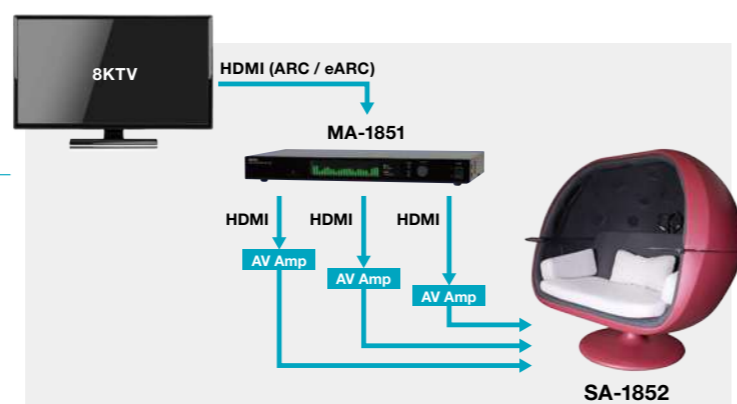

Specifications

- Front L/R : 8cm 2-Way 8Ωmax.100W
- Center : 8cm 2-Way 8Ωmax.100W x 2
Virtual center playback method with left-right placement
- Surround : 5cm 8Ωmax.100W x 18
- Woofer L/R : 16cm 8Ωmax.150W

What is "Resolution"?

Easily and Accurately.

RealMTF

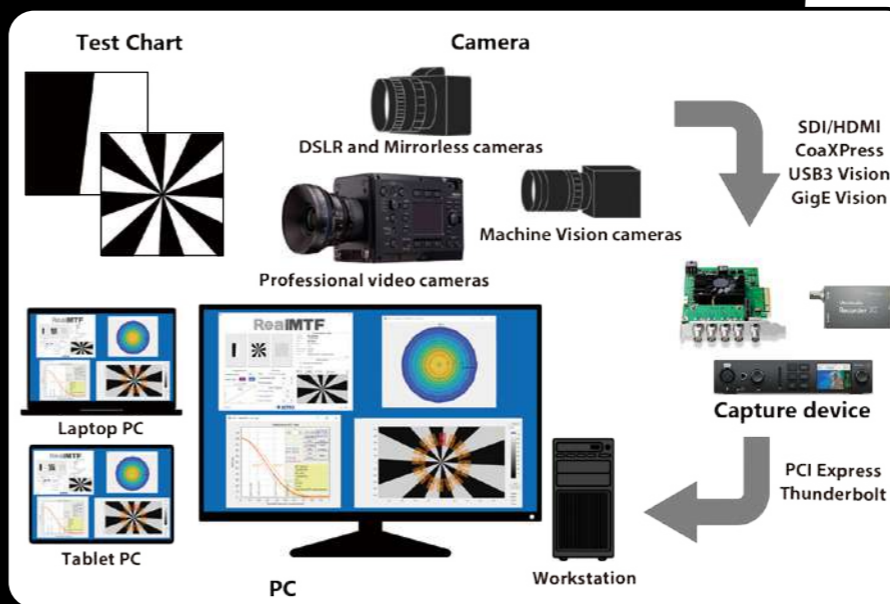

Features

- Real-time camera MTF measurement using a new edge-based method
 - Capable of measuring MTF quantitatively and with high accuracy, rather than qualitatively by visual evaluation
 - Capable of measuring the camera MTF of any position and direction
 - Supports simultaneous MTF measurement in multiple directions
 - Capable of measuring while controlling focus, iris, and zoom
 - Reduces camera noise by adding frames
 - Curved edges with distortion aberrations can also be analyzed
- Support of conventional MTF measurement as specified by ISO 12233, etc.
- Camera noise measurement
- Support of various camera interfaces
 - Supports SDI and HDMI input * IP-8030 only
 - Supports machine vision standards (CoaXPress / USB3 / GigE Vision)
- Camera and lens data acquisition (ARRI LDS / SMPTE RDD18 / GenICam)

Options

- **OP-4030-3/7** (Transmissive / Reflective)
Horizontal / Vertical Edge Chart
- **OP-4030-4/8** (Transmissive / Reflective)
Multidirectional Edge Chart (16 spokes)
- **OP-4030-1**
Chart Folder + Tripod
- **OP-4030-2**
Chart Frame Case
- **OP-4030-5**
Multidirectional Edge Chart (14 spokes)
- **OP-4030-6**
Chart Folder Only

Developed with the cooperation of the Japan Broadcasting Corporation (NHK)

Display MTF Measurement System **【DT-8031 / DT-8031-MV】**

Supports the measurement of the spatial resolution characteristics of any display.

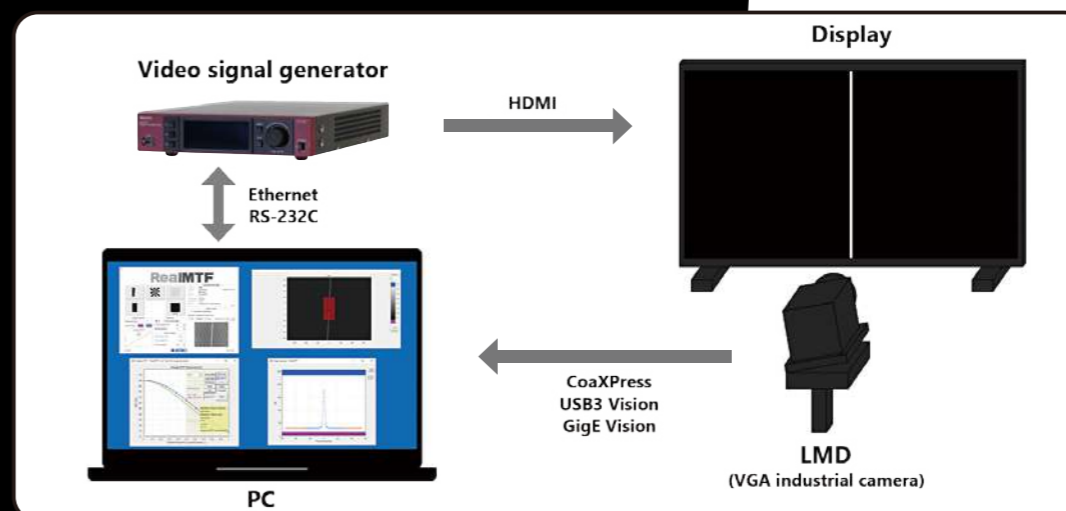

Features

- Measurement application combining a signal generator and an LMD.
- Capable of measuring the spatial imaging performance of displays.
- The newly developed line-based measurement method is supported.
- Freely set the measurement magnification of the display MTF (Pixel Ratio).

Note)

- DT-8031 supports all functions of IP-8030.
- SDI / HDMI input is supported by DT-8031 only.

Options

- **OP-8031-1**
Display MTF measurement jig set
- **OP-8031-2**
Display MTF measurement camera * Includes lens and filter
- **VG-887**
Video signal generator * HDMI 2.1 supported

Developed with the cooperation of the Japan Broadcasting Corporation (NHK)

Record Uncompressed Full Specification 8K (8K 120p RGB 4:4:4) Without Missing a Second

Full Specification 8K Recorder **[HR-7520]**



MM-212

While recording and playing back ultra-high resolution uncompressed video, this product provides evidence during research and development. It can also be used as a source for large capacity data.

HR-7520

Features

- Uncompressed recording of 8K 120p / 100p / 60p / 50p signals
- Uncompressed recording of 4K 120p / 100p / 60p / 50p signals
- 120p recording and playback by 12G-SDI Quad x 2 or U-SDI x 1
- Synchronous multiple unit operation supporting high frame rates of 240p and higher
- Usage of the SSD pack "MM-212 (8TB)" as a recording medium which utilizes NVMe SSD. * SSD sold separately
- Supports high resolution and high frame rate conditional to the number of SSD packs used
- Ability to edit or delete recorded clips and create a playlist by combining multiple clips
- Supports backup via 10GbE
- Supports up to 32 channels of audio recording
- 4U rackmount size

Supported Format Table

Video Format	Supported I/F	Recording Time Required Number of MM-212 During Usage	Required Number of MM-212
4K YC _B C _R 4:2:2 50p / 59.94p / 60p	12G-SDI x 1	75 min.	1
4K YC _B C _R 4:2:2 100p / 119.88p / 120p	12G-SDI x 2	75 min.	2
8K YC _B C _R 4:2:2 50p / 59.94p / 60p	12G-SDI x 4	75 min.	4
8K YC _B C _R 4:2:2 100p / 119.88p / 120p	12G-SDI x 8	75 min.	8
8K YC _B C _R 4:2:2 50p / 59.94p / 60p	U-SDI x 1	75 min.	4
8K RGB 4:4:4 50p / 59.94p / 60p		50 min.	4
8K YC _B C _R 4:2:2 100p / 119.88p / 120p		75 min.	8
8K RGB 4:4:4 100p / 119.88p / 120p		50 min.	8

8K Video Server **[SR-8428(8K 240p Input) SR-8438(8K 60p Input) SR-8450(8K 60p 4 Input 2 Output)]**

Avoid Missing a Critical Moment

Record 4 Hours of 8K 240p
Record 8 Hours of 8K 60p



Features

- Simultaneous recording and playback of a 4-hour continuous loop of 8K 240p (SR-8428)
- Simultaneous recording and playback of a 8-hour continuous loop of 8K 60p (SR-8438)
- Simultaneous recording and playback of a 4-hour continuous loop of 4 lines of 8K 60p (SR-8450)
- Simultaneous playback of up to 2 lines of 8K 60p signals (SR-8450)
- Simultaneous output of 4K and HD down-converted signals
- Equipped with Grass Valley HQX Codec for long-term recording with high image quality
- Variable speed slow playback via remote controller
- Independent playback for 2 lines of output by using 2 remote controllers (SR-8450 only)
* Option to add controller at extra cost (SR-8450 only)
- Ability to register, edit, or delete clips during recording and create a playlist by combining multiple clips
- Supports up to 32 channels of audio recording
- Supports audio channel assignment for 4K and HD down-converted signals

8K SSD Recorder **[HR-7518 (60 Hz Model) HR-7518-A(120 Hz Model)]**

Bring 8K to Any Shooting Site

Simple 8K Editing, 8K Production Workflow



Features

- Compressed recording using Grass Valley HQX Codec
- Compressed recording / uncompressed recording of 8K Dual Green (2 SSD packs necessary for uncompressed recording)
- Optional expansion module allows recording of Full-Featured 8K (8K RGB 4:4:4 120p) (compressed recording only)
- 12G-SDI as standard input / output terminal
- Optical input / output terminal of U-SDI (ARIB STD-B58) is installed as a standard
- Equipped with dual slots for SSD packs
- Relay recording (excluding some recording formats)
- Support for recording up to 32 channels of audio (uncompressed, 24-bit)
- Dual AC power supply (60 Hz model HR-7518 only)
- 2U rack mount size

Specifications

Item	Specifications
Video Format	8K (7680 x 4320) Dual Green 59.94p
	8K YC _B C _R 4:2:2 59.94p
	8K RGB 4:4:4 59.94p
	8K YC _B C _R 4:2:2 119.88p*
Video Input / Output	8K RGB 4:4:4 119.88p* * HR-7518-A only
	3G-SDI (SMPTE 424M / ST 425-1) x 8ch Supports ancillary data (Audio, TC)
	12G-SDI (SMPTE ST 2082-1) x 4ch U-SDI (ARIB STD-B58) x 1ch Supports ancillary data (Audio, TC)
Data Transfer	USB 3.0



8K Converter Lineup

Convert to the Signal You Need

8K Converter Compatibility Table

		SC-8229	SC-8222	SC-8221	SC-8220	SC-8219	SD-7076	SD-7075-A	VC-8429	FC-8216A
Interface	U-SDI			IN	OUT					
	12G-SDI	IN / OUT	IN / OUT	OUT	IN	IN / OUT	IN		IN	
	6G-SDI	IN / OUT								
	3G-SDI	IN / OUT				IN / OUT				IN
	1.5G-SDI	IN / OUT				IN / OUT				IN
	HDMI 2.1						OUT	OUT		
HDMI 2.0							IN	OUT	OUT	
Format	8K RGB			IN	OUT		OUT	IN / OUT	OUT	OUT
	8K YC _B C _R	IN / OUT	IN / OUT	OUT	IN	IN / OUT	IN / OUT	IN / OUT	IN / OUT	IN / OUT
	8K Dual Green					IN / OUT				IN
	4K YC _B C _R	IN / OUT				IN / OUT	IN / OUT	IN / OUT		
HD YC _B C _R	IN / OUT				IN / OUT					
Frame Rate	120p / 111.88p		IN / OUT	IN / OUT	IN / OUT		IN / OUT	IN / OUT		
	60p / 59.94p	IN / OUT	IN / OUT	IN / OUT	IN / OUT	IN / OUT	IN / OUT	IN / OUT	IN / OUT	IN / OUT
	50p	IN / OUT				IN / OUT	IN / OUT	IN / OUT	IN / OUT	
	30p / 29.97p / 25p / 24p / 23.98p	IN / OUT					IN / OUT	IN / OUT		
	30PsF / 29.97PsF / 25PsF / 24PsF / 23.98PsF	IN / OUT								
60i / 59.94i / 50i	IN / OUT					IN / OUT				
Frame Rate Conversion	●		●	●	●					
Dynamic Range Conversion	●					●				
Color Gamut Conversion	●					●				

We make an expansive range of 8K converters essential to system creation. By utilizing our converters which support a variety of formats and interfaces, it is possible to convert to the required signal in any situation.



SC-8229 8K Cross Converter

This device up-converts and down-converts various types of 8K 60p YC_BC_R 4:2:2, 4K, and HD video signals. It is equipped with dynamic range conversion and color gamut conversion using 3D LUT and frame rate conversion.



VC-8429 Interface Converter

Converts 8K 60p YC_BC_R 4:2:2 to HDMI 2.0 x 4



SC-8222 8K 120Hz Converter

Mutually converts 12G-Quad (8K 60p YC_BC_R 4:2:2) Odd / Even and 12G-Dual (4K 120p YC_BC_R 4:2:2) x 4 for 8K 120p YC_BC_R 4:2:2 signal



FC-8216A Interface Converter

Converts 8K 60p YC_BC_R 4:2:2 to HDMI 2.0 x 4



SC-8221 8K U-SDI to 12G-SDI Converter

Converts U-SDI (8K 120p / 60p RGB 4:4:4 12-bit and 8K 60p YC_BC_R 4:2:2 10-bit) to 12G-SDI (8K 60p YC_BC_R 4:2:2)



SD-7076 12G-SDI to HDMI 2.1 Converter Box

Converts 12G-SDI (8K 60p YC_BC_R 4:2:2) to HDMI 2.1



SC-8220 8K 12G-SDI to U-SDI Converter

Converts 12G-SDI (8K 60p YC_BC_R 4:2:2) to U-SDI (8K 120p / 60p RGB 4:4:4 12-bit and 8K 60p YC_BC_R 4:2:2 10-bit)



SD-7075-A HDMI 2.0 to HDMI 2.1 Converter

Converts HDMI 2.0 x 4 to HDMI 2.1



SC-8219 8K Cross Converter

This device up-converts and down-converts various types of 8K 60p YC_BC_R 4:2:2, 8K Dual Green, 4K, and HD video signals.

SMPTE ST 2110 Compliant 8K IP Gateway with Support Up to 8K

8K IP Gateway [IG-5114]

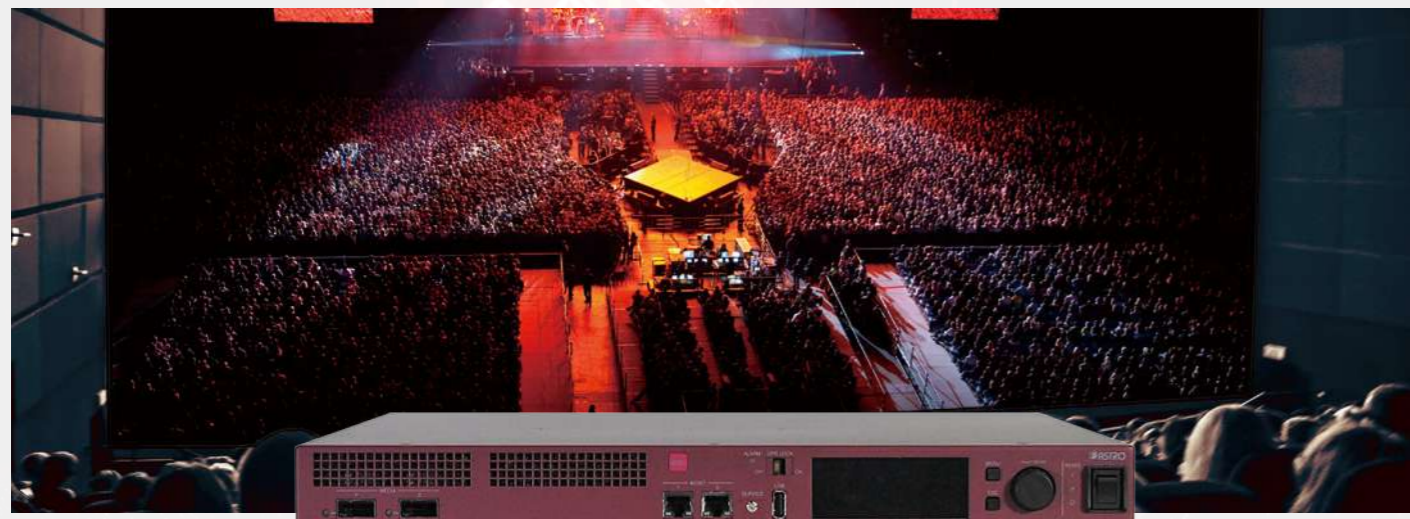

Amid growing demand for 8K video transmission for various events, live viewings, and medical-related fields, we present 8K / 4K / HD compliant video over IP Gateway that can mutually convert between SDI and IP and be used when transmitting uncompressed low latency 8K video.

IG-5114

Features

- Compliant with Video Over IP standards
 - SMPTE ST 2110-20 / 30 / 40 compliant and can transmit video, audio and ancillary data via IP
 - SMPTE ST 2059-1 / -2 compliant and can be operated via BMC (Best Master Clock)
 - Line redundancy via SMPTE 2022-7 (Hitless)
 - Supports LLDP / DHCP / DNS / NMOS / SDP, settings and operations are automated
 - Supports IPv4 Multicast
- Supports SDI to IP / IP to SDI
- QSFP28 (100GbE) transceiver can be installed
- Compatible with external synchronization signals (HD3 tri-level and BB)
- Supports time pulse (1PPS) output

Connection Example

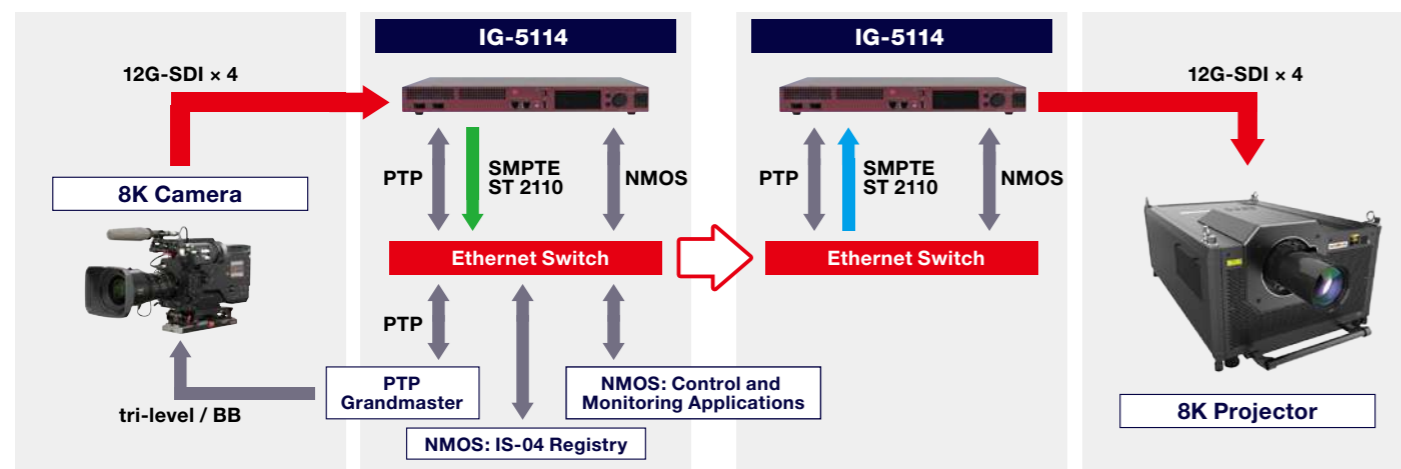

PCI Express Compliant 8K Frame Memory Board [GG-169]



GG-169 is a frame memory board that supports high-speed data transfer and can input and output uncompressed 8K video. With 12G-SDI x 4 lines (up to 8 lines with the use of an optional expansion board) equipped as standard, it achieves real-time output of 8K / 59.94p. Additionally, by using the composite function on the board, it is possible to combine and output frame memory video to the input 8K video.

* Photo includes expansion board.

Features

- Frame memory board specialized for 8K video
- Achieves data transfer speeds that can play out 8K video via PCI Express compliance
- Input and output of 8K video (2SI / SQD) by 12G-SDI x 4
- Combines frame memory video with input video and output
- Frame memory can be configured as FILL+KEY, ideal for telop systems output
- FILL+KEY output by 12G-SDI x 8 lines with one board with the use of optional expansion board
- SDK included (for Windows 10; contact ASTRODESIGN for different OS)

PCI Express Compliant HD / 4K Frame Memory Board [GG-170]

The successor to the popular GG-167-HD / 4K, this is an uncompressed HD / 4K video input and output compliant frame memory board.

With 1.5G / 3G / 12G (selection) of SDI x 4 (up to 8 lines with the use of an optional expansion board) equipped as standard, real-time output of HD to 4K / 59.94p can be achieved.

Additionally, by using the composite function on the board, it is possible to combine and output frame memory video to the input HD / 4K video.



Features

- Frame memory board specialized for HD / 4K video
- Achieves data transfer speeds that can play out HD / 4K video via PCI Express compliance
- Equipped with 1.5G / 3G / 12G (selection) of SDI x 4 (up to 8 lines with the use optional expansion board) as standard
- Combines frame memory video with input video and output
- Frame memory can be configured as FILL+KEY, ideal for telop systems output
- SDI x 8 lines with the use of optional expansion board and supports various outputs such as FILL+KEY, OnAir, and Next with one board
- SDK included (for Windows 10; contact ASTRODESIGN for different OS)

30.2-inch 8K LCD Monitor **[DM-3830]** 12G

**8K Input (12G-SDI x 4) Compliant
30.2-inch 8K Resolution LCD Monitor**



Features

- Utilizes a high brightness LCD panel
- Possible to display 8K video Dot-by-Dot
- Possible to switch and display two lines of 8K signals
- Active through output of input signal
- Supports HDR [Hybrid Log-Gamma (HLG: ITU-R BT.2100) and Perceptual Quantizer (PQ: SMPTE ST 2084)]
- Supports ITU-R BT.2020, ITU-R BT.709
- Possible to enlarge display by 2x and 4x
- Manufacturer display
- Image adjustment function (contrast, brightness, peaking)

SDI Input / Output Specification

Item	Specifications	
	8K	4K
Supported Formats		
Resolution	7680 x 4320	3840 x 2160
Frame Rate	50p / 59.94p / 60p	50p / 59.94p / 60p
Tone	YC _B C _R 4:2:2 10-bit	YC _B C _R 4:2:2 10-bit
SDI Format	12G-SDI Type 1	12G-SDI Type 1 / 3G-SDI
Related Standards	SMPTE ST 2082-1 / 12	SMPTE ST 2082-1 / 10 SMPTE ST 425-1 / -5

LCD Panel Specifications

Item	Specifications
Screen Size	30.2 inches
Resolution	7680 (H) x 4320 (V) Pixels
Display Mode	Transmissive, Normally black
Maximum Brightness	1000cd/m ²
Contrast Ratio	1,400:1
Color Gamut	NTSC ratio 80%
Viewing Angle	Horizontal 89°, Vertical 89°

Equipped with a Wide Variety of Audio Interfaces
Visualize Audio in Every Situation

12G-SDI Audio Monitor **[AM-3825]** 12G



Pursue viewing ease with a wide LCD pane / Various measurement screens

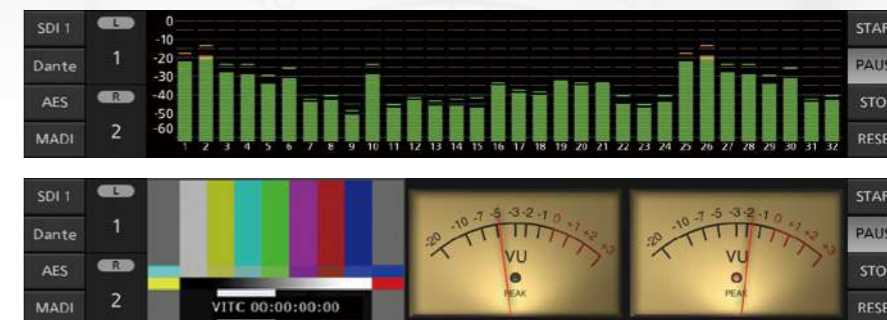

31.5-inch 4K OLED Monitor **[DM-3430]** 12G

**4K Input (12G-SDI x 1 or 3G-SDI x 4)
Compliant 31.5-inch 4K Resolution
LCD Monitor**

The ideal picture monitor for video production sites such as OB vans and editing rooms



Features

- Achieves high contrast with use of RGB OLED panel
- Possible to display 4K video Dot-by-Dot 4K
- Equipped with anti-burn function
- Supports Square Division and 2-sample interleave division for video divide method
- Supports both resolution inputs 3840 x 2160 and 4096 x 2160 *
- Active through output of input signal
- Supports HDR [Hybrid Log-Gamma (HLG: ITU-R BT.2100) and Perceptual Quantizer (PQ: SMPTE ST 2084)]
- Enabled switching for system gamma of HLG
- Supports ITU-R BT.2020, ITU-R BT.709
- Possible to enlarge display by 2x and 4x
- Manufacturer display
- Image adjustment function (contrast and brightness)
- Focus assist function (peaking)
- Built-in test pattern display
- Thin body that utilizes OLED panel (Depth: 52mm excluding the stand)
- Possible to attach VESA

* The resolution of panel itself is 3840 x 2160. When a signal with 4096 x 2160 resolution is input, only the central 3840 x 2160 area is displayed.

AM-3825

Features

- Wide variety of supported video formats
- Equipped with various audio input / output interfaces
- Loudness measurement function
- Simultaneous monitoring of up to 32 channels of audio
- L/R speakers as standard feature
- LCD display with superior visibility
- Preset function
- User button function
- Downmix function
- Control function by GPIO remote controller
- Alarm output function to external devices
- Space-saving housing
- AC power compatible

● Free remapping of input audio to output audio



* excluding the main unit speaker and SDI output



SB-4024-A
SB-4027
SB-4031

4K Conversion Board

- SB-4024-A: 3G-SDI Compatible**
4K-HD Cross Converter
- SB-4027 : 3G / 12G-SDI Compatible**
4K-HD Cross Converter
- SB-4031 : 3G / 12G-SDI Compatible**
4K-HD Down Converter

A converter board that supports 4K and HD input / output, and is capable of resolution conversion, format conversion, and color gamut conversion.

Features

- 4K ⇄ HD Up conversion, down conversion
- HDR ⇄ SDR ID LUT, various camera log support
- ITU-R BT.2020 ⇄ ITU-R BT.709 3D LUT support
- 1D LUT, 3D LUT user data import
- Downmix embedded audio, channel mapping
- Supports web browser control
- Supports monitoring and control of multiple boards using a GUI app for batch control
- Can be mounted to the Sony NXL-FR316 and the ASTRODESIGN BE-4028
- Supports SR Live for HDR (optional)



BE-4028 Board Enclosure

Features

- Up to two 4K converter boards, SB-4024-A, SB-4027, SB-4031, can be mounted simultaneously
- Redundant power supply
- 1U rack size



HD-1679 4K DSK

4K DSK / USK:
2 lines
Super* (FILL, KEY) 8 lines

Features

- 12G-SDI / 3G-SDI / HD-SDI compatible
- Can be used as DSK / USK for HD
- Asynchronous input between each super*
- AVDL function
- Connect up to 2 remote controllers
- Redundant power supply
- Down convert preview output (only 12G-SDI, 3G-SDI x 4 2SI) (optional)
- Up convert super input, convert color gamut, EOTF, OETF function (optional)



HD-1678 HDTV Inserter

HD DSK / USK:
2 lines
Super* (FILL, KEY) 8 lines

4K DSK:
1 line
Super* (FILL, KEY) 2 lines

Features

- 3G-SDI / HD-SDI compatible
- Supports asynchronous input between each super*
- AVDL function
- Connect up to 2 remote controllers
- Redundant power supply



VC-7063
VC-7063-1

Stereo Composer / 3D Keyer (VC-7063-1)

Condensed functions necessary for 3D conversion

3G / HD-SDI, HDMI compatible 3D composer. Mutual conversion between two L / R signals and 1 3D signal, like Side by Side is possible. 3G / HD-SDI ⇄ HDMI interface and format conversion is also possible. There are many examples of applications in medical fields for 3D formatting and interface conversion.

Features

- Compatible with several conversion methods such as Side by Side, Top and Bottom, Line by Line, Field Sequential, Frame Packing (*HDMI only), Anaglyph, and Side by Side copy (VC-7063-1)
- Alignment function
- Mirror function
- Color correction function
- Frame synchronization function
- Enlargement / reduction function
- Alarm output terminal (VC-7063-1 only)
- 3D keyer function (VC-7063-1 only)



AM-3825 12G-SDI Audio Monitor

For further details, see P23.



AM-3807
AM-3807-A

Audio Loudness Meter

Equipped with a 7-inch color LCD to emphasize visibility and operability

Measures the loudness value of multiple SDI / AES audio signal inputs. Also manages the surround sound level, phase monitoring between the channels, and the sound image management easily.

Features

- Overwrite re-measurement functions with time code management
- Log storage / reading function to USB memory
- Loudness range display
- Spectrum analyzer function
- Needle meter function
- Demultiplex function



HW-7066 Closed Caption Rasterizer

Rasterizer Specialized for Monitoring Materials with Closed Captions

Displays HD subtitles, SD subtitles, mobile phone subtitles, and analog closed captions. Also supports external characters (DRCS). In addition to subtitle display, it supports the decoding display of inter-station control signals (conforming to ARIB STD-B39) and CM code (conforming to ARIB TR-B23).

Features

- HD subtitles, SD subtitles, analog closed captions, and mobile phone subtitles
- CS packet (Clear Screen) monitoring function
- History display
- Ancillary data display
- CM code (compliant with ARIB TR-B23) and inter-station control signal (compliant with ARIB STD-B39) decode display
- Log management software (optional)



HW-7069 4 Input Rasterizer

The New VE Desk Monitor

On the modern VE's desk, it is common to see several monitors, ID display machines, and waveform monitors. ASTRODESIGN proposes a product that will combine these into one unit.

Features

- Up to 4 lines of video and waveform are displayed on one screen
- Layout of information such as images, waveforms, vectors can be changed easily
- Interlocking CCU and switcher is possible
- 3G-SDI compatible



DM-3417A 12-inch 4K LCD Monitor

Compact and Lightweight 4K LCD Monitor

This small and lightweight monitor uses a 12-inch 4K resolution LCD to display full screen 4K.

Features

- Dot-by-Dot QFHD display
- Supports 4K (3840 x 2160 / 59.94p YCbCr 4:2:2 10-bit, Square Division, 2-sample interleave division) input
- Supports 12G-SDI x 1 input, 3G-SDI x 4 input 2 lines of 12G-SDI x 1 input, 1 line of 3G-SDI x 4 inputs available
- Supports HDR [Hybrid Log-Gamma (HLG: IT-R BT.2020), Perceptual Quantizer (PQ: SMPTE ST 2084)], S-Log 3)
- ITU-R BT.2020, ITU-R BT.709 compatible
- Zoom (MAG) function. 2-times magnification. After enlargement, you can specify 5 levels of enlargement horizontally and vertically
- Test pattern output to monitor (SMPTE color bar, gray scale, window, 50% flat field)
- Focus assist function



DM-3430 31.5-inch 4K OLED Monitor

For further details, see P22.



DF-3515 Full HD Electronic View Finder

Full HD 1920 x 1080 Resolution OLED Installed

Features

- HDR display function
- Supports HD-SDI multi-format input
- HDMI input
- Low latency
- Peaking, upside-down function, x2 x4 magnification display
- HDMI to SDI conversion function (Not supported during 4K input)
- Mono, Blue Only function

Postium 4K / HD Monitor

* Japanese market only

Direct 12G-SDI input and HDR compatible 4K monitor



2-screen or 3-screen HD monitor perfect for checking video footage



OBM-U241
24-inch LCD Monitor

Features

- 9, 17, 24, 31-inch lineup
- 3G / 6G / 12G input supported
- ST 2110 supported by using SFP module
- Depending on the module chosen, IP input is supported
- HDR display function PQ (SMPTE ST 2084) or HLG EOTF curve supported
- Compatible with several companies camera logs (S-Long2, 3, Log-C, C-Log, J-Log1 etc.)
- Audio, time code, waveform, vector display
- AC / DC compatible



PRM-503A
5-inch 3-screen Monitor



PRM-702A
7-inch 2-screen Monitor



PRM-102F
10-inch 2-screen Monitor

Features

- Compatible with multiple formats (SMPTE 125M, 292M)
- 3G-SDI compatible (PRM-102F only)
- Analog input supported
- Waveform, vector, audio level monitors display function
- Equipped with speaker and earphone jack (except for PRM-503A)



WM-3206B
WM-3206B-A

4K Input Waveform Monitor

4K Compatible Waveform Monitor

Features

- 2K and 4K compatible
- HD-SDI (Dual / Single Link) and 3G-SDI (Level A / B) signal inputs supported
- Square Division / 2-sample interleave division transmission methods supported
- HDR (HLG, PQ, S-Log and Canon Log) waveform display
- ITU-R BT. 2020 input supported
- Layout can be set freely
- WM-3206-A is a DC 12V type model



SD-7822 HD / 3G-SDI PID CHECKER

Features

- Device for displaying HD / 3G-SDI signal format information, presence / absence of audio packets, time code information, and more
- Compact, lightweight, battery-driven, single hand operation, ideal for signal confirmation at relay sites

HDMI 2.1 (8K) Compliant Signal Generator

Digital Video Generator **[VG-876 / VG-879]** HDMI 2.1 Compliance Test



VG-876 / VG-879

Main Features

- Supports the latest digital video interfaces such as HDMI 2.1, DisplayPort 1.2a, V-by-One® HS and 12G-SDI.
- Max. 4 interface slots are installed. Changes to unit configuration are possible.
- Supports 8K / 120p (V-by-One® HS) by synchronizing VG-876 / VG-879
- Supports HDR10+ and Dolby Vision evaluation with optional image collection

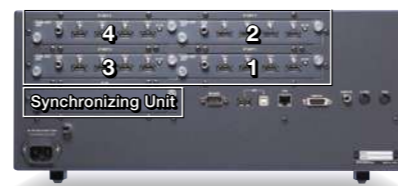

HDMI 2.1 Unit HDCP 2.3 HDR NEW

VM-1876-MD (Supported by VG-879 only)
HDMI 2.1 based module. 8K / 60p YCbCr_{4:2:0} and 4K / 120p YCbCr_{4:4:4} transmission are supported. FRL and TMDS modes are supported. DSC 1.2a is also supported.



HDMI 6G Unit HDCP 2.3 HDR

VM-1876-M8
HDMI 2.0b based module. 4K / 60p YCbCr_{4:4:4} transmission is supported. Possible to switch between HDCP 2.3 and 1.4.



HDMI 3G Unit HDCP 1.4 HDR

VM-1876A-M0
HDMI 2.0b based module. 4K / 60p YCbCr_{4:2:0} transmission is supported. Four outputs.

DisplayPort Unit

VM-1876A-M1
DisplayPort 1.2a based module. 4K / 60p RGB 4:4:4 transmission by SST and MST are supported. 5.4Gbps (HBR2) is supported. HDCP is not supported.

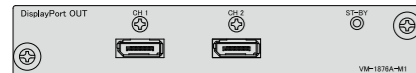

Analog Unit

VM-1876-MA
VGA, Composite video signal (NTSC / PAL), and audio outputs are supported.

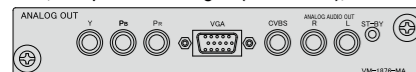

V-by-One® HS Unit

VM-1876-M2
4K / 120p and 8K / 30p transmission possible from a single unit. 8K / 120p transmission is possible by using four VG units each equipped with VM-1876-M2 and VM-1876-MX.



12G-SDI Unit

VM-1876-MB (Supported by VG-879 only)
4K / 60p video signal can be displayed with one line of 12G-SDI, two lines of 6G-SDI, or four lines of 3G-SDI. Arbitrary insertion of payload into SDI signal. Up to 8 channels of audio and timecode packets are embedded.



3G-SDI Unit

VM-1876-M5
3D-SDI, HD-SDI, and SD-SDI transmission. Four outputs.

iTMDS Unit

VM-1876-M9
4K / 60p is supported by a single unit, 4K / 120p is supported by two units. Conversion to LVDS is possible by using optional adapter IA-1540.

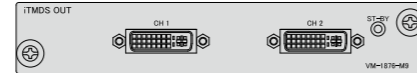

HDBaseT Unit

VM-1876-MC
HDMI 4K and full HD long-distance transmission is possible with a single LAN cable. HDBaseT 2.0, 4K / 30p supported, HDMI 1.4 supported.



Options for Digital Video Signal Generator

VT-7010 8K / 4K Evaluation Image Library (Option for VG-876 and VG-879) NEW

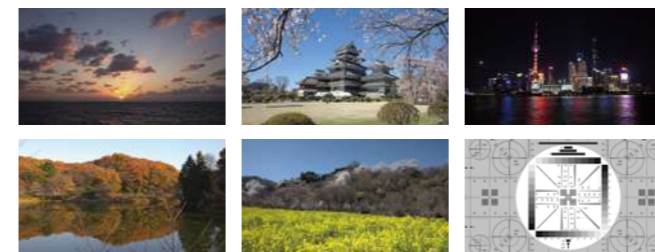

- Includes 10 types of nature images, 8K monoscope, and Chinese monoscope
- Two sizes available, 3840 × 2160 and 7680 × 4320 (FRL and TMDS timing compatible) (Monoscope is also available in 4096 × 2160 and 8192 × 4320)
- Nature pictures available in 1000 nits, 4000 nits, and HLG; 8-bit, 10-bit, and 12-bit images are available for each.

VT-7009 8K / 4K HDR Evaluation Image Library (Option for VG-876 and VG-879)

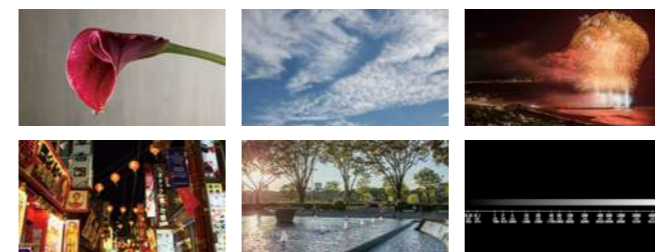

- Includes 14 types of still images. There are two resolutions, 3840 × 2160 and 7680 × 4320 (FRL and TMDS timing compatible).
- 10 and 12-bit versions of nature images available
- Nature images available in 1000 nits, 4000 nits, HDR2SDR, and HLG
- SMPTE ST 2084 and ARIB STD-B67 linear RAMP and 16 Step Gray added to built-in VG pattern
- Objective evaluation with scale (upper row is % value, lower row is digital value of HDMI output)

VT-7007 Ultra-High Definition / Wide Color Gamut Standard Test Image Library (Option for VG-876 and VG-879)

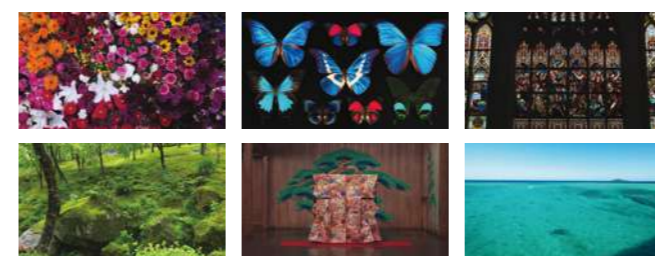

Ultra-high definition and wide color gamut standard images include a total three formats, two resolutions (8K and 4K) specified in ITU-R BT.2020 (Rec.2020), which is the UHDTV studio standard established by ITU-R, and one resolution (2K), which is compliant with the conventional HDTV studio standard ITU-R BT.709 (Rec.709), that can be output from the signal generators VG-876 and VG-879.

* Copyright: Institute of Image Information & TV Engineers · Association of Radio Industries & Businesses
* Source: Institute of Image Information & TV Engineers
* It is necessary to obtain permission from ITE before using VT-7007 in exhibitions, etc.
<https://www.ite.or.jp/content/test-materials/>

SP-8870-BM Brightness Measurement Tool NEW

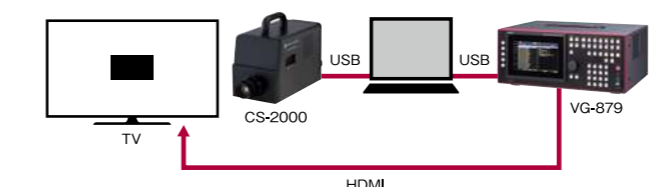

By connecting VG-879 with CS-2000 Spectroradiometer or CA-410 Display Color Analyzer (by KONICA MINOLTA, INC.), this software automatically outputs the desired test pattern from VG-879 and the test result of CS-2000 or CA-410 is sent to the PC. This helps to reduce operators working time who, up until now, were forced to control both products manually.

HDMI 2.1 Compliance Test Tool (Option for VG-879 and VG-1876-MD)



An option enabled VG-879 can perform HDMI 2.1 Compliance Test (Sink Test) by using SP-8870 software.

VT-7013 HDR10+ Test Evaluation Contents Library (Option for HDMI Units) HDR10+

- HDR10+ test specification compliant sample programs (based on 350cd luminance, can be edited to desired luminance value. Still image evaluation)
- Test program stores HDR10+ compliant InfoFrame

VT-7012 Dolby Vision Evaluation Content Library (Option for HDMI Units)

- Includes test patterns with metadata for Dolby Vision
- 2K and 4K of 8-bit image data
- Program data with Dolby Vision compatible Vendor Specific InfoFrame

VT-8500-0021 MPEG-4 AAC Audio Data (Option for HDMI Units)

- Includes three types of audio data: sine wave, channel confirmation audio, and music (Swan Lake)
- Stores 2ch, 5.1ch, and 22.2ch data respectively
- Supported program data is HD, 4K, and 8K

VT-8500-0006 HDMI High Bitrate Audio (Option for HDMI Units)

This option provides a compressed audio program that includes high bit rate audio and 1-bit audio.

Supported Formats

- DTS-HD Master Audio
- DTS Express (DTS-HD LBR)
- DTS-HD High Resolution Audio
- DTS Digital Surround
- Dolby Digital Plus
- Dolby TrueHD
- DSD (One Bit Audio)

SP-8871 Image Conversion / Creation Tool (Option for VG-876 and VG-879)

Software that converts BMP, JPG, TIFF format files to VGD format files. Bit conversion of 8, 10 and 12 bits is possible at the time of file conversion. Additionally, it is possible to combine consecutive still images into one image or file and play it as a video from VG-876 or VG-879. One second of 4K / 60p and 4 seconds of HP / 60p video can be played. (BMP, JPG, TIFF, VBM)



12G-SDI Signal Generator



VG-886 12G-SDI Signal Generator

- Supports 12G-SDI, 6G-SDI, 3G-SDI, HD-SDI signal output
- Supports 8K, 4K, 2K video output (up to 8K / 60p, 4K / 120p)
- 8K / 120p video output is possible by synchronizing two units
- Payload ID and time code embedded
- 32ch of embedded audio
- Supports external reference input / output
- Adjustable phase of reference output as well as SDI output
- User ID display
- Control from PC (LAN / RS-232C)

Specialized for Real-time Analysis, the Best Solution for Developing HDMI 2.0b / 2.1, HDCP 2.3 Equipment!

HDMI 2.1 / HDCP 2.3

4K / 120p YC_BC_R 4:4:4
8K / 60p YC_BC_R 4:2:0 Support
eARC, DSC 1.2a Support
Protocol Analyzer

[VA-1847] HDMI 2.1 Compliance Test HDR

HDMI 2.0b / HDCP 2.3

4K / 60p YC_BC_R 4:4:4 Support
Protocol Analyzer

[VA-1842] HDMI 2.0b Compliance Test HDR
HDCP 2.3 Compliance Test



The above photo is VA-1847

Easy and immediate start to analyze.

Receiver Mode (Sink Emulation)

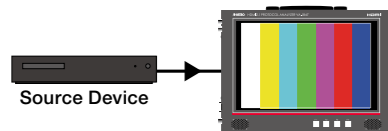

Supports emulation operation, protocol analysis and video timing measurement for sink functions for TVs, etc. via EDID settings.

Repeater Mode (Repeater Emulation)



Confirms that the output device operates correctly as a repeater.
* No input video display on VA-1847

Generate Mode (Source Emulation)

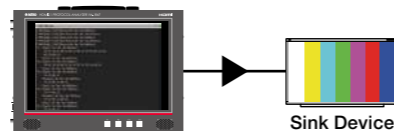

Supports operation and protocol analysis for source devices and outputs standard signals as a simple signal generator.

VA-1847

A protocol analyzer that can analyze protocol layers in the development of transmitters with an HDMI 2.0b / 2.1 interface. Equipped with a 12-inch LCD touch panel and built-in speaker, it can analyze video, sound, and protocol timing in real-time. In addition, this device also checks the signal reception and communication line of sink devices via the generate (signal transmission) function.

Main Functions

Receiver Mode (Measurement Function)

- Signal reception of FRL signal (max. 12G / 4L) of the CTA-861-G Video Identification Code (VIC) and TMDS signal (5K / 10K not supported)
- Video / audio timing, InfoFrame measurement, and display of HDCP status and SCDC register
- Analysis of SCDC and HDCP 1.4 / 2.3 as well as CEC with the inclusion of the DDC / CEC line monitor function
- DSC 1.2a encoded signal reception and analysis
- eARC output

Generate Mode (Signal Output Function)

- Output of FRL signal (max. 12G / 4L) of the CTA-861-G VIC and TMDS signal (5K / 10K not supported)
- HDCP 1.4 / 2.3 ON / OFF
- DSC 1.2 signal output
- eARC / ARC signal reception

Repeater Mode

- Device can be set as a repeater and HDMI protocol analysis of HDMI output devices can be performed.

Compliance Test

- HDMI 2.1 compliance test

EDID

- EDID edit function and emulation function to read EDID from sink devices. EDID emulation can be saved.

Equipped with 12-inch Touch Panel

- Up to 8 windows can be displayed simultaneously. Intuitive operation via touch panel.

What is HDMI 2.1 ?

HDMI (High-Definition Multimedia Interface) 2.1 is a standard for transmitting digital video and audio for consumer devices such as LCD TVs and BD players over a single cable, announced in November 2017. The bandwidth of data transfer has been extended from the conventional 18Gbps to 48Gbps, enabling the transmission of 8K / 60p and 4K / 120p over a single cable.

New features of HDMI 2.1 include

- Dynamic HDR
- Up to 10K resolution using DSC 1.2a
- eARC, an extension of the ARC standard
- Enhanced refresh rates of VRR, QMS, and QFT
- ALLM (Auto Low Latency Mode) which allows for the automatic switch to low-latency mode for sink devices

In addition, since connectors and cables have not changed, conventional connectors and cables can be used as they are. Furthermore, as it is backward-compatible, it is possible to, for example, connect and HDMI 2.1 TV to an old HDMI interface BD player. Our company participated in the HDMI Forum to develop HDMI 2.1 and cooperated as a measurement equipment manufacturer from the beginning stages of standardization.

In order to view beautiful images, a high-definition display is necessary, but equipment needed to transmit said images cannot project clear images unless it itself is of high quality. As a pioneer in this field, ASTRODESIGN supports R&D and the production of digital AV equipment.

Protocol Analyzer



VA-1847 HDMI 2.1 / HDCP 2.3 Protocol Analyzer

HDMI 2.1 Analyzer with CTS Function

Each function of the latest HDMI 2.1 / HDCP 2.3 can be evaluated and measured.

Features

- HDMI 2.1 / HDCP 2.3 compatible
- TMDS and FRL (max. 12G / 4L) measurement
- 4K / 120p YC_BC_R 4:4:4 and 8K / 60p YC_BC_R 4:2:0 timing support
- Support for 3 test modes: receiver mode, generate mode, and repeater mode
- Video / audio timing, InfoFrame measurement, and analysis of HDCP 2.3 / 1.4 and SCDC
- eARC signal transmission / reception function, ARC signal reception function
- EDID emulation and DDC / CEC monitor function
- DSC 1.2a input / output
- 12-inch touch panel and built-in speaker
- HDMI 2.1 compliance test function



VA-1842 HDMI 2.0b / HDCP 2.3 Protocol Analyzer

HDMI 2.0b Analyzer with CTS Function

Each function of the latest HDMI 2.0b / HDCP 2.3 can be evaluated and measured.

Features

- HDMI 2.0b / HDCP 2.3 compatible
- Up to 4K / 60p YC_BC_R 4:4:4 timing input / output
- Support for 3 test modes: receiver mode, generate mode, and repeater mode
- Video / audio timing, InfoFrame measurement, and analysis of HDCP 2.3 / 1.4 and SCDC
- EDID emulation and DDC / CEC monitor function
- 12-inch touch panel and built-in speaker
- HDMI 2.0 and HDCP 2.3 compliance test function

HDMI Tester



VA-1844A HDMI Tester

Thin, Lightweight, and Portable HDMI Tester

The latest functions of HDMI 2.0b and HDCP 2.3 can be checked on the spot. Inter-device connectivity check and cable test functions are implemented.

Features

- HDMI 2.0b / HDCP 2.3 compatible
- Up to 4K / 60p YC_BC_R 4:4:4 timing input / output
- Support for 3 test modes: receiver mode, generate mode, and repeater
- Video / audio timing, InfoFrame measurement, and analysis of HDCP 2.3 / 1.4 and SCDC
- EDID emulation and DDC / CEC monitor function
- DDC / CDC line monitoring using through mode
- 7-inch touch panel and built-in speaker
- Compact size: 269 (W) x 182 (H) x 41 (D)mm
- Weight: 1.25 kg



Analysis Screen Test Screen * Optional

Tester for Production Lines



VA-1849 HDMI 2.1 Source Tester

HDMI Automatic Inspection Device

This device is an HDMI 2.1 / HDCP 2.3 compatible automatic inspection device. It is possible to measure and analyze HDMI output equipment and freely set test items by command.

Features

- HDMI 2.1 / HDCP 2.3 compatible
- TMDS and FRL (max. 12G / 4L) measurement
- Transmission / reception of 8K / 60p YC_BC_R 4:2:0 8-bit signal and up to 8K / 60p RGB 12-bit signal with DSC ON
- Supports analyze mode (input port x 2) and generate mode (output port x 1)
- Video / audio timing, InfoFrame measurement, analysis of HDCP 2.3 / 1.4 and SCDC, and pass / fail judgement
- DDC / CDC line check
- Repeater equipment and cable check inspection by using two VA-1849 units
- DCS 1.2a input / output
- Command operation supported
- UtilitySoft supported (optional)



VA-1845 HDMI 4K Source Tester

HDMI Automatic Inspection Device

This device is an HDMI 2.0b / HDCP 2.3 compatible automatic inspection device. It is possible to measure and analyze HDMI output equipment and freely set test items by command.

Features

- HDMI 2.0 / HDCP 2.3 compatible
- Measurement up to 4K / 60p RGB 4:4:4 8-bit
- Supports analyze mode (input port x 2) and generate mode (output port x 1)
- Video / audio timing, InfoFrame measurement, analysis of HDCP 2.3 / 1.4 and SCDC, and pass / fail judgement
- DDC / CDC line check
- Access check of EDID, HDCP, and SCDC
- Repeater equipment and cable check inspection by looping input / output
- Command operation supported
- UtilitySoft supported (optional)

Application Example

Video Data Check

Input and comparison patterns can be set in advance for comparison inspection. It is possible to inspect data parts which are difficult to analyze visually.

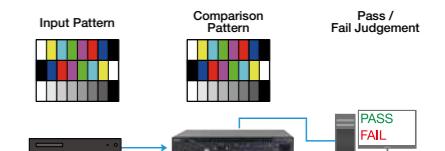

UtilitySoft (Optional)

GUI-based software for basic commands. It can be used for evaluation before line introduction.

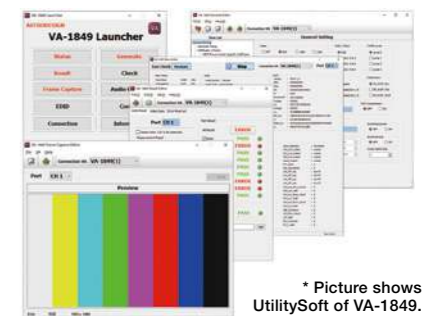

* Picture shows UtilitySoft of VA-1849.

Compatible Function Comparison

	Receiver Mode	Through Mode	Repeater Mode	Generate Mode	Standard	4K2K	8K4K	HDCP	CTS	R&D	Production Line	Service
VA-1847	○	Optional	○	○	HDMI 2.1	30Hz / 60Hz / 120Hz	60Hz	2.3 / 1.4	○	◎	×	○
VA-1842	○	Optional	○	○	HDMI 2.0b	30Hz / 60Hz	×	2.3 / 1.4	○	◎	×	○
VA-1844A	○	○	Optional	Optional	HDMI 2.0b	30Hz / 60Hz	×	2.3 / 1.4	×	◎	○	◎
VA-1849	○	×	×	○	HDMI 2.1	30Hz / 60Hz / 120Hz	60Hz	2.3 / 1.4	×	△	◎	△
VA-1845	○	×	×	○	HDMI 2.0b	30Hz / 60Hz	×	2.3 / 1.4	×	△	◎	△

◎: Exclusive

Universal Video Platform **[LS-8500]** in development

A next-generation multi-I / F measurement device that focuses on users customization by utilizing the technology of signal generators and analyzers.

LS-8500 GT-171

Features

- Equipped with 4 HDMI 2.1 connectors for simultaneous output (for the same signal)
- Plan to support VRR
- Plan to support eARC and audio data
- HDR metadata can be edited
- Supports FRL / TMDS signal output

LS-8500 GX-173

Features

- Supports HDMI 2.1 input / output (1 output, 1 input)
- Fixed signal output from HD to 8K
- FRL (up to 12Gbps / 4 lanes) and TMDS signals can be received and analyzed
- Video / audio timing, InfoFrame measurement, and SCDC register display

* Specifications are subject to change without notice as product is in development. Contact our sales department for details.

Cable Tester [CT-1860]

HDMI Checker [CT-1860-HDMI]

Easily measure transmission loss of the physical layers of the HDMI 2.1 cable. The frequency characteristics (8K FRL / TMDS) are displayed graphically.

CT-1860 Cable Tester



2U half size

CT-1860-HDMI HDMI Checker

(CT-1860-HDMI can be equipped with CT-1860 or used alone)

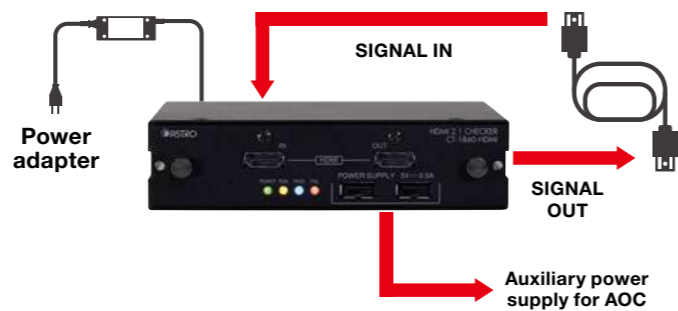

CT-1860-HDMI can be used alone to confirm pass / fail judgement. Also, it can be mounted in CT-1860 for more detailed measurement, and to display the test results graphically on the front screen or through the PC application.

Features

- Evaluation of transmission characteristics for each TMDS line
- Graphical display of frequency characteristics (when using CT-1860)
- Output amplitude can be changed by user
- Connection check and voltage display of control lines (DDC / HPD / CEC)
- Broadband measurement of 100MHz-15GHz
- Measure the +5V line consumption power value
- Pass / fail judgement with CT-1860-HDMI alone
- Saving of measurement results as CSV and BMP files
- PC application software can be used
- Calibration kit (optional)

Max. 8K resolution (12Gbps / 4-lane)
Easy Operation and Cost-Effective Solution

HDMI 2.1 Signal Generator **[VG-887]**



VG-887

Features

- Signal generation by FRL (max. 12Gbps / 4-lane) and TMDS modes. DSC 1.2a is supported.
- Uncompressed 8K / 60p YC_BC_R 4:2:0 and 4K / 120p YC_BC_R 4:4:4 transmission.
- FRL Link Training, SCDC and EDID status check.
- Pre-installed test patterns and users' own image data can be output.
- Video level change, Window size change and scroll functions are supported.
- HDCP 2.3 and 1.4 test
- PC control by LAN or RS-232C.

Pattern

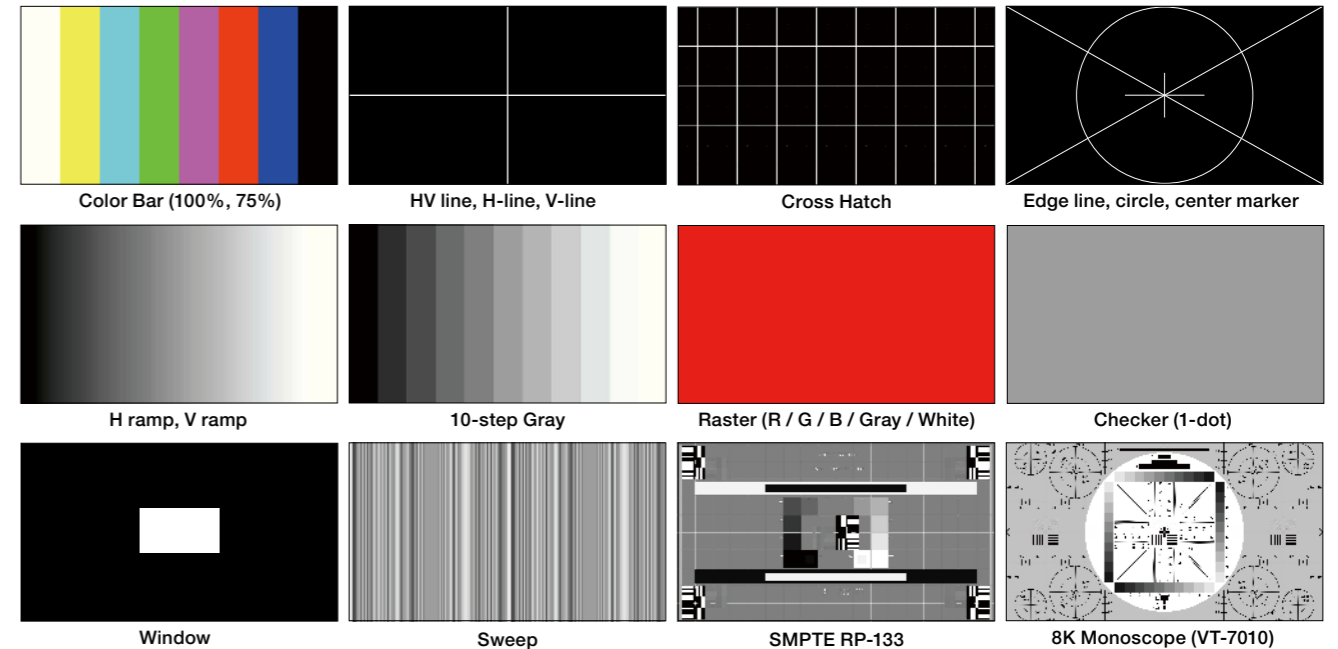

Optional 8K natural image libraries and 8K monoscope patterns are available. (VT-7009 / VT-7010)

Specifications

Item	Specifications
Power Requirements	AC100-240V
Power Consumption	60W MAX
Dimensions	210 (W) x 44 (H) x 300 (D) mm (1U half, Excluding Protrusions)
Weight	Approx. 2kg

Rear View

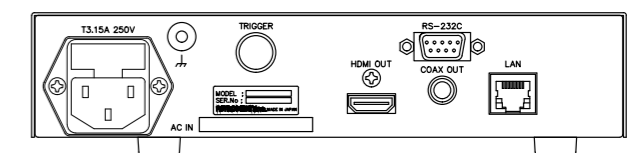

16K4K Supported Multi-Video Processor

ASTRODESIGN's uniquely developed video conversion algorithm enables high-speed resolution conversion while maintaining real-time scaling and high image quality.

Multimedia Scan Converter [MC-2087]

Multimedia Scan Converter [MC-2085 / MC-2086]

High-Definition Display

Simulator / Presentation / R&D
Assumed Display: Fine pitch LED / Projector / LCD

Provides an environment for special systems that require high-definition reproducibility. One example of this simulation systems requiring detailed images displaying actual size and color or image quality comparison of different video in a high-definition state



Indoor / Outdoor Large-scale Display

Racing Facility / Signage
Assumed Display: Specialized LED

Provides an environment for large-scale display for entertainment, displaying video in the optimum size even if the display board differs from the video standard, as well as important text information that matched the video in quality



Collective Multi-Information Display

Crisis Management: Transportation / Lifeline / Disaster prevention measures
Assumed Display: Multi-LCD / Multi-DLP

Develops video and graphic information from various situations based on high-definition map information and provides an environment for crisis management that enables accurate situational judgement

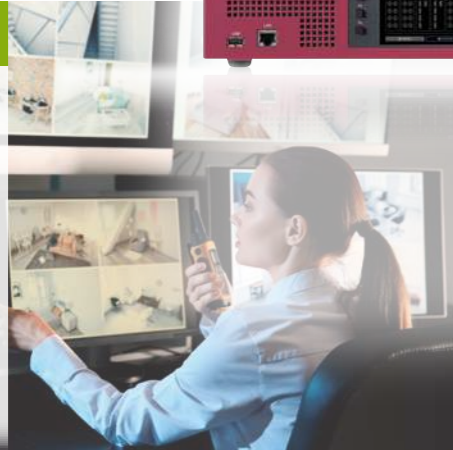

Medical Sites: Information Communication / Conference
Assumed Display: 4K Monitor / Projector

Assists in advanced medical solutions by collectively displaying electronic information, such as electronic medical records and medical videos from surgical cameras, endoscopes, and microscopes

MC-2087

Freely develop video necessary for collective multi-information display / indoor / outdoor large-scale display / high-definition display

MC-2087 is video composition / division device capable of 8K signal input and output. It is possible to seamlessly input video signals, perform I / F conversion and scan conversion, composite video, and display cut-out display. Employing slot type input / output interface boards, it will always function with the latest standard connectors. Up to 16 lines for 8K signal input / output and up to 64 lines for 4K signal input / output can be processed. It is possible to support video over 16K by connecting multiple images. It is effective for simultaneously displaying multiple video materials on large-scale LED vision displays at horse race and racing facilities, on large-scale signage at commercial facilities, at disaster prevention offices or surveillance centers, board room meetings, etc.

Features

- Supports internal BUS video area [8K x 2 screens] and can process 8K signal with Dot by Dot
- Utilizes original zoom algorithm / motion adaptive IP conversion algorithm (10-bit arithmetic processing)
- EOTF / OETF compatible
SDR⇄HDR conversion for each input channel (Plan to support 3D LUT in the future) / ITU-R BT.709⇄ITU-R BT.2020 conversion
- Supports high frame rate signals such as 4K120p
- Input signal distribution function
- KEY composition / fade composition function
- Video rotation function (optional)
- Web browser setting (can be set independently without the MC itself)
- Simple monitoring image can be displayed on the front display
- Multiple connection control
- Case size: 4U / IF board: Up to 8 can be mounted
- Replaceable fan unite / power unit
- Supported interfaces
HD / 3G / 12G-SDI / HDMI 2.1 / DisplayPort 1.4 (Phase 2 or later) / IP (Phase 2 or later)



MC-2085



MC-2086

8K2K Supported Multi-Video Processor

It is a multi-video processor that can process 8K2K high resolution size in real-time.

Employing slot type input / output interface boards, it supports 3G(HD)-SDI / DVI / HDMI 2.0 / DisplayPort 1.3.

Equipped with external controls of LAN / RS-232C / remote contact, it can be controlled with various control devices.

Features

- Original zoom algorithm / 10-bit arithmetic processing with use of motion adaptive IP conversion algorithm
- Supports HDCP (MC-1561-D, MC-1561-H, MC-1562-D, MC-1562-H)
- Web browser setting
- Aspect mode selection
- Key synthesis, video rotation (option)
- Joint / blending area setting
- Audio support (embedded / main unit output)



MI-2100 Media Integrator

Multifunctional Digital Multi-switcher

It is a processor with a built-in scan converter that supports use with multiple screens. It also supports HDCP and is ideal for multi-display systems, such as those used for surveillance, signage, and conference room facilities.

Features

- I / O up to 68 channels
- Equipped with 8.4-inch touch panel for intuitive operation
- Audio support (embedded / main unit earphone)
- Aspect mode selection
- EDID emulation (output copy)
- Joint / blending area setting



RB-1650C Remote Box

- 16-button learning function allows registration of commands for each button
- RS-232C (9600 bps, 19200 bps, 38400 bps auto detection)
- DC 5V power supply (AC adapter included)
- Dimensions: 160 (W) x 40 (H) x 110 (D) mm



SC-2065B Flexible Scan Converter

Ideal Entry Model for Presentations or Events

Possible to carry out format conversion, interface conversion, and aspect ratio conversion mutually compatible with HD / SD-SDI and DVI-D digital interface and component YPbPr / Y (R-Y) (B-Y) / RGB, VBS analog interface video standards. In addition to up-conversion and down-conversion with just one unit, users can extract only the necessary part of the input video and set the output position freely, so it can be used in a various situations such as recording / editing, presentation, events, and output to special equipment.

Features

- HDCP compatible (DVI)
- Various input / output interfaces
- "TERA" high image quality scaling processing (12-bit arithmetic processing)
- "Astrosnap" high image quality I / P conversion processing (12-bit arithmetic processing)
- Intuitive front menu operation
- WebUI, command control, SNMP monitoring via Ethernet connection



RB-1636A Remote Box

- 16-button contact type and can switch to MC-2085 / 2086 mask
- No power supply required
- Dimensions: 85 (W) x 30 (H) x 120 (D) mm



SC-2067B Flexible Scan Converter

3G-SDI, Audio Compatible Superior Model

It is an universal type video processor covering a wide range, including RGB, component YPbPr / Y (R-Y) (B-Y), and composite VBS analog interface video standards, in addition to DVI-D and HDMI in the digital category, and from SD-SDI to 3G-SDI in the SDI category. It supports not only video but also audio, SDI embedded audio, HDMI digital audio, and external analog audio. It also supports It also supports SNMP monitoring via LAN connection and can be used safely as a baseband or transmission equipment as well as standalone.

Features

- HDCP compliant (HDMI / DVI)
- Audio support (input selection, optional delay setting possible)
- Various input / output interface
- "TERA" high image quality scaling processing (12-bit arithmetic processing)
- "Astrosnap" high image quality I / P conversion processing (12-bit arithmetic processing)
- Intuitive front menu operation
- WebUI, command control, SNMP monitoring via Ethernet connection

A Diverse Product Lineup for Stream Multiplexing,

Analysis, IP Transmission, and More!

MPEG-2 TS Multiplexer [CX-5548]

- DVB-ASI x 4 input multiplexer
- DVB-ASI x 1 (4 output distribution) (plan to expand to DVB-ASI x 4)
- IP encapsulation function (encapsulation / decapsulation)
- Dual power supply support



IP Encapsulation / Decapsulation Overview Diagram

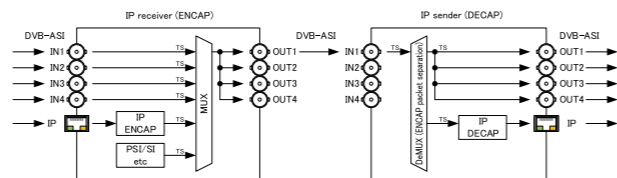

Main Unit Rear View

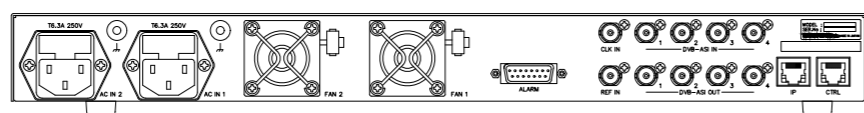

CX-5545 MMT Multiplexer

Use for evaluation of BS / CS broadcasting systems and services in combination with CX-5546

- Features**
- 2 IP input ports, 1 IP output port, 1 monitor out port
 - Possible to receive multiple IP data flows, multiplex multiple IP data flows and send out
 - MMT-SI input and multiplexing



CX-5546 TLV Multiplexer

- Features**
- 1 IP input port, 1 IP output port, 1 monitor out port
 - Possible to receive multiple IP data flows and send out one TLV stream
 - TLV-SI input and multiplexing



CP-5541A MMT Recorder & Player

Recording and Playback of MMT Multiplexing Streams

- Features**
- 256GB SSD installed (approx. 3 hours at 200 Mbps recording time)
 - 200 Mbps stream can be recorded without loss and played back
 - Time stamp replacement output
 - Files compatible with two formats, pcap and an original format



CX-5539 TS Multiplexer

TS Multiplexer for Broadcast Main Line Equipment

- Features**
- Supports IP x 2 input and multiplexing
 - DVB-ASI x 12 input and multiplexing possible
 - Possible to set four levels of multiplexing priority for each PID
 - Output is DVB-ASI x 4 lines (distribution)
 - Dual power supply support
 - 3U rack mount size
 - Input is in slot format and can be configured according to application and system

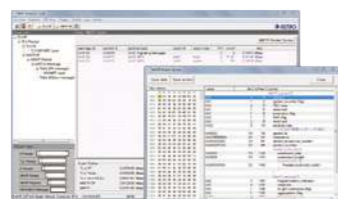

SP-5800 MMT Analyzer

Analysis of MMT Multiplexing System Streams

- Features**
- MMT and TLV analysis
 - Supports real-time analysis and offline analysis
 - Syntax analysis
 - Stream recording
 - MMTP stream time stamp and NTP jitter analysis
 - Use as a monitoring device in combination with a PC

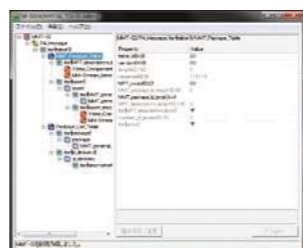

SP-5018 MMT-SI / TLV-SI Editor

- Features**
- MMT-SI and TLV-SI creation and editing
 - Standard check functions

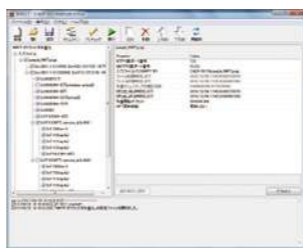

SP-5017 MMT Simulator

MMT Test Stream Creation / Editing

- Features**
- MMTP / IP file and MMT-SI multiplexing
 - File cutting
 - IP address and packet ID replacement

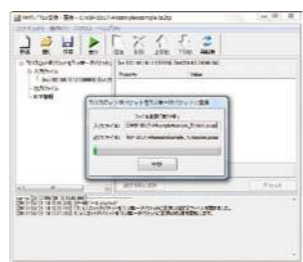

SP-5017-A TLV / MMT Conversion Application

File Format Conversion

- Features**
- Mutual conversion of MMTP / IP, Single TLV, and Composite TLV
 - Replacement of composite TLV service configuration information

ISDB-T Backup Unit [CB-5542]

- TS over IP transmission after compressing the bandwidth of broadcast TS
- FSYNC output and 10MHz clock output
- Bidirectional transmission with one sender / receiver
- Remote operation and information acquisition

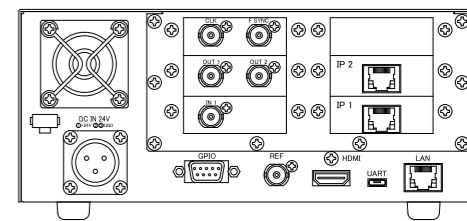
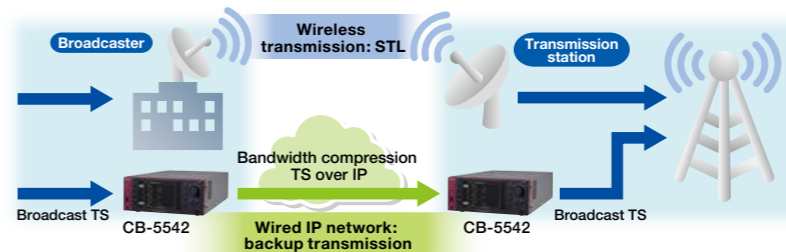

TS-7815D TS Analyzer

Ideal for On-Site Stream Checking

- Features**
- Portable TS analyzers with compact design
 - Ready for use immediately after powering on
 - Monitoring, analysis, and information display of major packets and section headers included in the TS stream
 - Setting trigger conditions according to usage
 - TS data recording, log output, and alarm output with automatic trigger



CB-5542-E / F IPass

Transmits UDP / IP Data over TS Transmission Path

- Features**
- Achieves high bit rate IPDC IP over TS
 - Supports UDP / IP data input over 200 Mbps
 - Used in opposition with CB-5542-E used on sending side and CB-5542-F used on reception side



CW-5543 TS Monitoring Device

Multi-system TS Monitoring for Broadcast Transmission Facility

- Features**
- Simultaneous monitoring of up to four TS with one monitoring device
 - Display of PID information, PSI information, program information, and PCR information
 - Remote confirmation of input information via web browser
 - Possible to check status of multiple CW-5543 units with included Windows application



CX-5544 TS Monitoring / Transmission Device

Ideal for TS Monitoring and Recording in Remote Location

- Features**
- Monitoring of one TS
 - Remote monitoring via SNMP Trap and Get
 - Recording of input TS on built-in SSD
 - Transmission of input TS via TS over IP

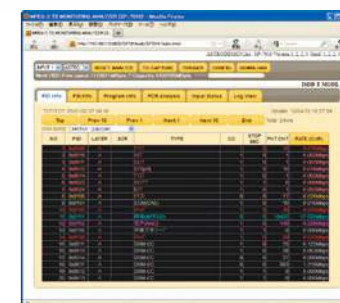

SP-7816 MPEG-2 TS Monitoring Analyzer

Specialized Analyzer for TS Monitoring

- Features**
- Remote monitoring of results via general web browser
 - Real-time simultaneous analysis of two TS series
 - PID specific information display, PCR analysis (Interval / Jitter), PSI / SI section detailed analysis function etc.
 - Alarm notification by log output and SNMP trap according to trigger condition
 - ETSI TR 101 290 First Priority and Second Priority compliant monitoring and alarm notification
 - TS analysis recording
 - Description analysis display of IPTV · ISDB-Tmm

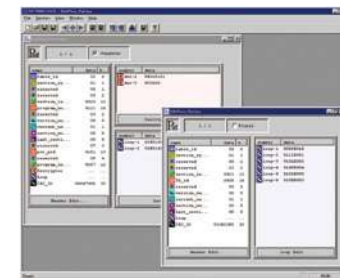

SP-5000-ARIB ARIB Standard Compliant PSI / SI Editor

Essential Application for Test Stream Creation

- Features**
- Highly flexible data editing with intuitive GUI
 - Supports multiple sections (sub-table)
 - Supports private sections, nonstandard tables, and nonstandard descriptor screens
 - CRC_32 automatic calculation function

Using Our Large Catalogue of Video Equipment and Skills, We Here at ASTRODESIGN Offer a Wide Range of Services.

[8K Equipment Rental and Production Support]

We offer rentals of our 4K and 8K equipment as well as support for 8K filming and post-production. Our editing room and 8K theater are also available for booking.



Underwater Filming

Underwater Housing for the 8K Camcorder

Measurement

8K 120p Camera

VR

8K Multi-purpose Camera

[8K Showroom]

Experience the most immersive ultra-high definition 8K video and multi-speaker surround sound system.

At the Astrodesign headquarters showroom, we will introduce you to not only our permanent exhibition of 8K equipment, but also to the latest in 8K technology. Our 8K theater is equipped with an impressive 170-inch screen and can play 8K 3D and 8K 120Hz video with supported 22.2ch surround sound audio. In addition, any footage that is still in post-production can be viewed in surroundings as close to the actual screening environment as possible.

The 8K theater at Astrodesign Headquarters

[8K Content Purchase]

Our original 8K content is available for purchase. It can be used for 8K equipment demonstrations, R&D, and many other applications.

<p>VT-8014</p> <p>Japanese Cherry Blossoms 2m53s</p>	<p>VT-8302</p> <p>ASTRO NINJA 3m09s</p>	<p>Dance content currently in production</p> <p>Special content such as VR, vertical video, and 120p video are being prepared.</p>
<p>VT-7006</p> <p>The Kushimoto Sea 3m42s</p>	<p>VT-8400</p> <p>Motocross 4m33s</p>	
<p>VT-7008</p> <p>Martial Arts 3m00s</p>	<p>VT-7011</p> <p>Yakushima 4m05s</p>	

[8K Editing Room]

Our editing room is equipped with EDIUS, a non-linear turnkey editing system that allows you to edit 8K video timelines in 8K resolution.



Ultra High Speed Multi Framing Camera **[HC-4502]**

HC-4502 is an ultra high-speed multi-framing camera that shoots 10 frames consecutively at a maximum speed of 100 million frames per second (10nsec).



Features

- Same number of pixels at all frames rates
- Repetitive (trigger synchronization) low-light phenomena shooting with charge accumulation shooting function
- Programmable trigger output function
- Easy operation via GUI application

Use Case Examples

- Initial state analysis of an electric discharge, plasma generation, explosion, or shock wave
- Biological cell imaging
- Analysis of high-speed pressure-sensitive paint

* This product is provided by our shooting service. Contact our Business Development Department for details.

16-Lens Multi-Spectrum Camera in development



A camera perfectly suited for multiple applications, including but not limited to, the agricultural and industrial fields.

Features

- Utilizes 8K monochrome image sensor
- Possible simultaneous shooting of 16 wavelengths
- Mechanism for filter change

* We will support your research using this camera. Contact our Business Development Department for details.

Blue	420nm	530nm	770nm
Green	450nm	550nm	850nm
Red	500nm	600nm	940nm
ND1.5	ND0.3	700nm	970nm

Filter Configuration Example

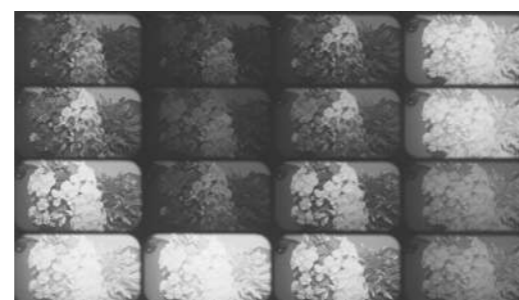

Sample Video

Laser Microscope **[LM-9002]**

LaSCOPE

Laser Scanning Optical Pupil Extension Microscope

LM-9002 achieves transmissive-type, unstained, super-resolution observation due to its unique optical aperture expansion technology and our specialty high-speed digital signal processing technology!

In addition to complete separation of intensity and phase, information such as polarization can be observed in real-time at the same time and position! Furthermore, not only the transmission, but also reflection observation functions have been reinforced!

ASTRODESIGN offers a powerful and unprecedented observation method. (3 patents in the US, 3 in Europe, 16 in Japan)



LM-9002

Features

[Fusion of original optical aperture expansion technology and high-speed digital signal processing technology]

- **Real-time multi-method observation**
Achieves simultaneous comparative observation of various types of information via the real-time visualization of multiple types of optical information, such as intensity information, phase information, and polarization information, at the same time, from the same place.
- **Super-resolution imaging beyond the light diffraction limit**
Achieves resolution equivalent to NA1.20 (water immersion) with a NA0.95 dry lens
- **Complete separation of intensity and phase information**
Enables complete separation of information that could not be achieved with conventional phase-contrast microscopes and observes faint phase information in detail

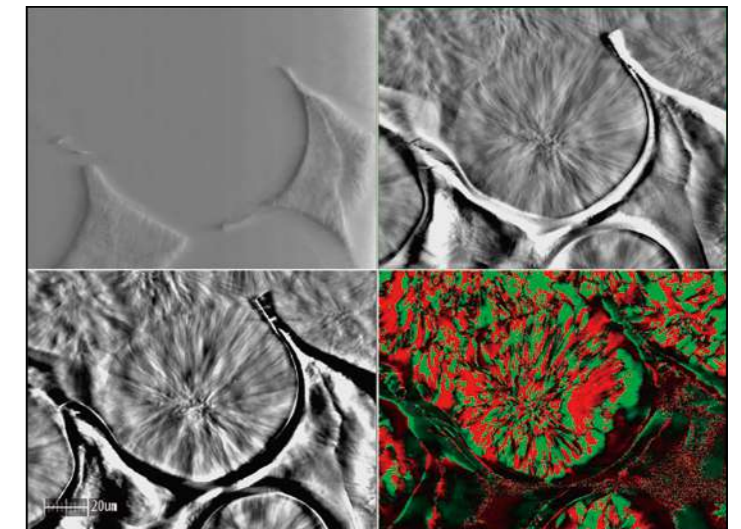

[New Proposal for LM-9002]

- **Various reflection observation functions added to real-time method**
Intensity information, phase information, fluorescence information
- **Effective for submerged observation**
Observation of dispersion and aggregation behavior of particles in liquid, etc.
- **Effective for the linked observation of the cross-disciplinary region of optical microscopes and electron microscopes**
Preliminary observation for electron microscope observation that requires troublesome pre-processing

ASTRODESIGN will continue to take on the challenge of "seeing more of what couldn't be seen before"!

* LaSCOPE is a registered trademark of ASTRODESIGN, Inc.



Hachikei Digital Art Cube is
new type of web platform.

<https://hachikei.com/>

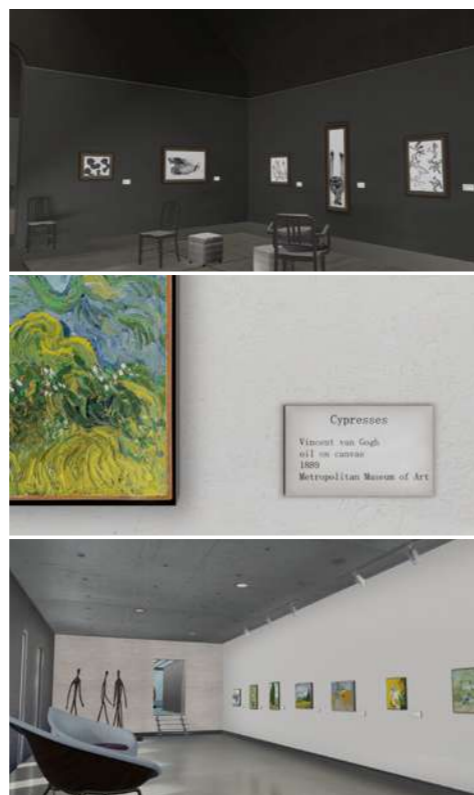

Features

- Integration of maximum 8K high-definition display technology and 3D technology
- Visitors can easily walkthrough
- Each piece as a whole and its respective details can be viewed at the same time
- Not only can paintings and calligraphy be displayed, but also sculptures, ceramics and other three-dimensional objects
- Plan to support video in future updates

We aim to be a new marketing tool, not only limited to art applications

AI Scaler (ASTRO Intelligence Scaler) [SP-2030]

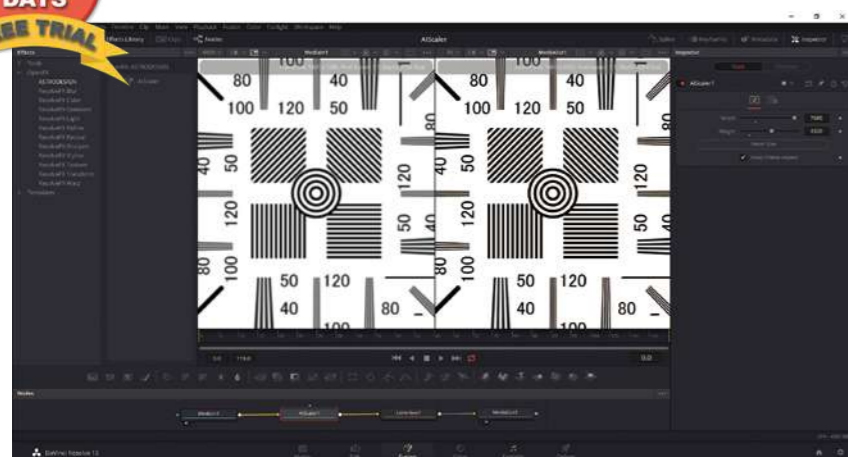

Features

- Combines high-speed processing and high image quality via an in-house-developed neural net
- Supports any output resolution up to 8129 x 8129. Supports cinema resolution and non-square pixels
- Possible to use with OpenFX plugin compatible software such as DaVinci Resolve® and Nuke
- 30-day free trial available
Why not start your free trial from the link below?

<https://www.astrodesign.co.jp/sp2030-aiscaler-trial.html>

Specifications

Item	Description
Provided Format	OpenFX Plugin
Confirmed Software	DaVinci Resolve® 15 and later Nuke / Nuke X / Nuke Studio 11.3 and later * Please contact us for latest confirmed software information
Function	Resizing
Possible Output Size	1x1 to 8129 x 8129 Input / output aspect holding function * Maximum size constraint based on GPU memory size
Input / Output Format	RGB RGBA A 8 / 16-bit integer 16 / 32-bit floating decimal

Operating Environment

Item	Description
Supported OS	Microsoft Windows10 (64-bit) Linux (64-bit)
GPU	NVIDIA® GPU Driver Version 418.39 and later Linux 418.39 and later Compute Capability 5.2 and above Compute Capability Confirmation Site https://developer.nvidia.com/cuda-gpus * NVIDIA® only supported
GPU Memory	8GB or more (4K), 16GB or more (8K) recommended

MADD.

Movie for Art, Design and Data

The first screening by the Lumiere brothers, said to be the fathers of film, was a scene of a train arriving at its last station. Moviegoers were said to have started running away, the image was so realistic to them.

At that time, the composite projector cinematography that they developed was just one of many new technologies. Who could have imagined that the world of rich film art would be born from it?

Georges Méliès shot the image of a humorous trip to the moon and brought narrative into the world of video. Luis Bunuel pioneered surrealistic expression that pierced the senses and captivated people with images full of eroticism and beautiful aesthetics.

Sergei Eisenstein pioneered montage theory and built a sort of visual grammar that expresses human emotions. In the meantime, film became art. Cannes and the Oscars have now become home to some of the most prestigious art prizes in the world.

Currently, 8K, VR, and lasers are only talked about in the context of technology.

But much sooner than we can imagine, artists will be discovered who will master these techniques and create gorgeous worlds that no one else could have conceived of.

Those creators will be the Méliès, the Bunuel, and the Eisenstein of the 21st century.

MADD. is an experimental site, a social center, and a workshop for that exact purpose.

MADD. book

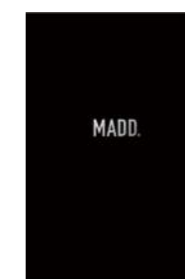

2019



2020

MADD. Committee

Next-Generation Image Consortium at the
Keio Research Institute at SFC
ASTRODESIGN, Inc.

<https://madd.jp>

Company Name	ASTRODESIGN, Inc.
Established	February 15, 1977
Capital	72 Million Yen
President and CEO	Shigeaki Suzuki
Officers	Vice President Tsutomu Mihara Directors Yoshiaki Tochimoto Yoshihito Manabe Lai Wayne Keiji Kimura Toyoaki Nanba Auditor Minoru Hosaka
Employees	170
Business Description	Focusing on high-speed digital signal processing technology, we carry out the design, manufacturing, and sales of video / image equipment and software, HDTV studio equipment, digital broadcasting equipment, and display measurement equipment, as well as the sale of other telecommunication / control / measurement related modules and systems.
Company History	<p>1977 Established in Tokyo, specializing the design and development of electronic equipment</p> <p>1979 Developed the world's first programmable video signal generator</p> <p>1985 Invited to participate in joint HDTV development with NHK</p> <p>1986 In response to growth, relocated to a new facility in Kawasaki</p> <p>1987 Kansai office opened in Osaka, serving Western Japan</p> <p>1990 Capital increased to 72 million yen</p> <p>1993 Kawasaki Technology Center opened</p> <p>1996 ISO 9001 certified (registration no.: JET-0056)</p> <p>1998 Tottori R&D Center opened</p> <p>1999 ISO 14001 certified (registration no.: E99-102)</p> <p>2002 Merger with affiliate NPS, head office relocated to Meguro-ku, Tokyo</p> <p>2005 UHDTV processor jointly developed with NHK for Expo 2005 in Aichi</p> <p>2007 Head office relocated to Ota-ku, Tokyo; consolidation of three Tokyo offices</p> <p>2010 Expanded 4K product lines (including cameras and recorders) in anticipation of UHDTV market growth</p> <p>2012 Subsidiary ASTRODESIGN, Inc. established in Silicon Valley, California</p> <p>2013 Expanded 8K product lines in anticipation of 8K trial broadcasting</p> <p>2016 Open "8K Suite" as 8K production facility</p> <p>2017 Developed world's first DLP 8K projector image processing board and supplied to Digital Projection Limited (A Delta Associate Company). Both companies are in charge of the projector.</p> <p>2018 LaSCOPE (Laser Scanning Optical Pupil Extension Microscope) Product Announcement</p> <p>Opened the "8K theater" in the head office as an 8K video preview facility</p>

Head Office
 1-5-2 Minami-Yukigaya, Ota-ku, Tokyo, Japan 145-0066
 Tel +81-3-5734-6300 / Fax +81-3-5734-6101
 www.astrodesign.co.jp

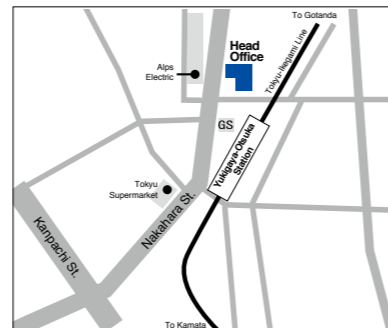

2-minute walk from Yukigaya-Otsuka Station, Tokyu-Ikegami Line

Osaka Sales Office
 1-18-27-1010 Higashi-Nakajima, Higashi-Yodogawa-ku, Osaka, Japan 533-0033
 Tel +81-6-6328-8558 / Fax +81-6-6328-5058

Tottori R&D Center
 1015-21 Ohara, Houki-cho, Saihaku-gun, Tottori, Japan 689-4102
 Tel +81-859-39-8200 / Fax +81-859-39-8201

USA Office
 780 Montague Expressway, Suite 302, San Jose CA 95131 USA
 Tel +1-408-435-7800 / Fax +1-408-435-7900
 info@astro-americas.com www.astro-americas.com



Product Lineup by Field

- Video**
- P4 8K Camera System
- P6 8K Camera Lineup
- P8 8K Camcorder
- P9 BOSMA IP Camera
- P10 8K Projector
- P12 High Performance Computing
- P16 8K Recorder
- P18 8K Converter
- P20 SMPTE ST 2110 Compliant IP Gateway
- P21 Frame Memory Board Series
- P22 8K / 4K Monitor
- P24 4K / HD Production Studio, OB Van, Production
- P32 System Integrating Processor
- P34 MMT / TLV / MPEG-2 TS Solution
- P40 Web-based Virtual Museum
- P40 AI Scaler (ASTRO Intelligence Scaler)

- Audio**
- P14 22.2ch Sound System
- P23 Audio Monitor
- P24 4K / HD Production Studio, OB Van, Production

- Measurement**
- P15 8K Real-time MTF Measurement System / Display MTF Measurement System
- P26 Video Signal Generator
- P28 Protocol Analyzer
- P30 Test & Measurement
- P31 HDMI 2.1 Signal Generator

- Science**
- P38 Multipurpose Camera System
- P39 New Laser Scanning Microscope

- Service**
- P36 8K Services

Model Number Index

A	AA-4814-B 8	I	IG-5114 20	T	TS-7815D 35
AB-4815 7	AB-4830 / AC-4829 6	INSIGHT Laser 37000 8K 10, 11	INSIGHT Laser 8K Imaging by ASTRO 10, 11	V	VA-1842 28, 29
AB-4831 6	AM-3807 25	IP-8030 15	IP-8030-MV 15	VA-1844A 29	VA-1845 29
AM-3807-A 25	AM-3825 23, 25	LM-9002 39	LS-8500 30	VA-1847 28, 29	VA-1849 29
AT-4820 / AR-4821 6	AT-8425 / AR-8426 8	L	MC-2085 33	VC-7063 24	VC-7063-1 24
AW-8800 12	B	MC-2086 33	MC-2087 32	VC-8429 18, 19	VG-876 26, 27
C	BE-4028 24	MI-2100 33	MM-210 / MM-210-1 7, 8	VG-879 26, 27	VG-886 27
CB-5542 35	CB-5542-E/F 35	MM-210 / MM-210-1 7, 8	OBM-U241 24	VG-887 31	VM-1876A-M0 26
CB-5544 35	CM-9010-B 7	PRM-102F 24	PRM-503A 24	VM-1876A-M1 26	VM-1876-M2 26
CM-9010-B 7	CP-5541A 34	PRM-702A 24	R	VM-1876-M5 26	VM-1876-M8 26
CT-1860 30	CT-1860-HDMI 30	RB-1636A 33	RB-1650C 33	VM-1876-M9 26	VM-1876-MA 26
CW-5543 35	CX-5539 34	RB-4816-2 6	S	VM-1876-MB 26	VM-1876-MC 26
CX-5544 35	CX-5545 34	SA-1852 14	SB-4024-A 24	VM-1876-MD 26	VT-7006 37
CX-5546 34	CX-5548 34	SB-4027 24	SB-4031 24	VT-7007 27	VT-7008 37
D	DC0200 9	SC-2065B 33	SC-2067B 33	VT-7009 27	VT-7010 27
DF-3515 25	DF-3516-A 6, 8	SC-8219 18, 19	SC-8220 18, 19	VT-7011 37	VT-7012 27
DM-3417A 25	DM-3430 22, 25	SC-8221 18, 19	SC-8222 18, 19	VT-7013 27	VT-8014 37
DM-3830 22	DT-8031 15	SC-8229 18, 19	SD-7075-A 18, 19	VT-8302 37	VT-8400 37
DT-8031-MV 15	F	SD-7076 18, 19	SD-7822 25	VT-8500-0006 27	VT-8500-0021 27
G	FC-8216A 18, 19	SC-8221 18, 19	SC-8222 18, 19	W	WM-3206B 25
GG-169 21	GG-170 21	SC-8229 18, 19	SD-7075-A 18, 19	WM-3206B-A 25	Other
H	Hachikei Digital Art Cube 40	SD-7076 18, 19	SP-2030 40	16-Lens Multi-Spectrum Camera 38	8C-B60A 8
HB-7517 7, 8	HC-4502 38	SD-7822 25	SP-5000-ARIB 35		
HD-1678 24	HD-1679 24	SP-5017 34	SP-5017-A 34		
HDMI 2.1 Compliance Test Tool 27	HP-7524 13	SP-5018 34	SP-5800 34		
HR-7518 17	HR-7518-A 7, 17	SP-7816 35	SP-8870-BM 27		
HR-7520 16	HW-7066 25	SR-8428 17	SR-8438 17		
HW-7069 25		SR-8450 17			

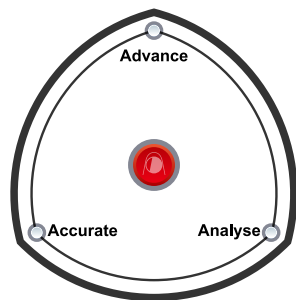

 contents



ASTRODESIGN, Inc.

Japanese ▶ <https://www.astrodesign.co.jp>
 English ▶ <https://www.astrodesign.co.jp/english>
 Chinese ▶ <https://www.astrodesign.co.jp/chinese>

Notes

- The terms HDMI and HDMI High-Definition Multimedia Interface, and the HDMI Logo are trademarks or registered trademarks of HDMI Licensing Administrator, Inc. in the United States and other countries.
- Company and product names in this catalog are trademarks or registered trademarks of their respective owners.
- Product specifications and appearance are subject to change without notice for improvement.
- TWITTER, TWEET, RETWEET, and the Twitter logo are trademarks of Twitter, Inc. or its affiliates.

ASTRODESIGN, Inc.

<https://www.astrodesign.co.jp>

● For more information, please contact us :

TOKYO Headquarters

TEL +81-(0)3-5734-6320 FAX +81-(0)3-5734-6102
 1-5-2 Minami-yukigaya, Ota-ku, Tokyo, Japan 145-0066

USA OFFICE

TEL +1-408-435-7800 FAX +1-408-435-7900
 780 Montague Expressway, Suite 302, San Jose CA 95131 USA
 URL <http://www.astro-americas.com>