

# LMG671

## Precision Power Analyzer

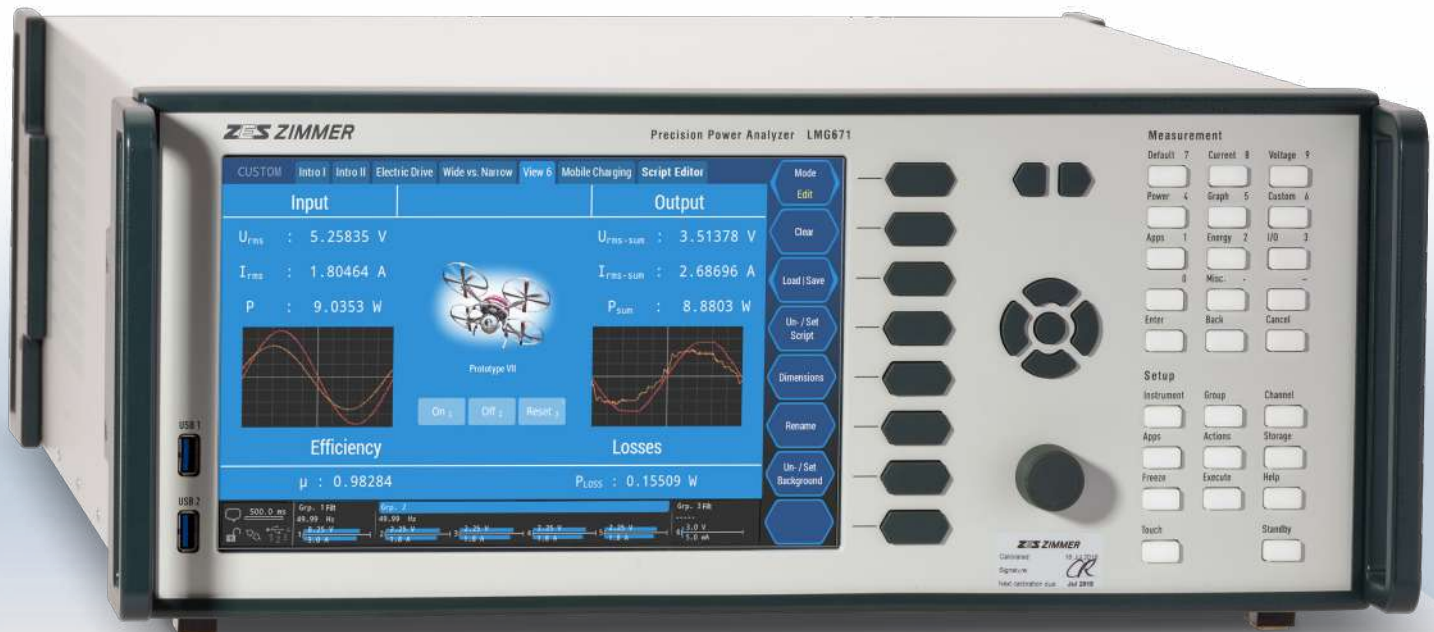

**Getting precise results does not have to be complicated**

# LMG671 – powerful, convenient, flexible

## Pushing the limits

- ✓ Measuring standby currents in the  $\mu\text{A}$  range and up to 32 A
- ✓ Market-leading analog bandwidth of 10 MHz
- ✓ Unique DualPath architecture eliminates aliasing dilemma
- ✓ Best-in-class accuracy

## Easy data exchange

- ✓ Collect data from any analog or digital sensor
- ✓ Plug into CAN bus to blend into automotive environment
- ✓ Continuously stream sample values for advanced post-processing
- ✓ Run our sophisticated analysis suite on captured data



## Fits to your task

- ✓ Configure the number and kind of your power channels for the best price and performance
- ✓ Sync to different frequencies on each channel group
- ✓ Focus on the relevant signal content with highly versatile filters
- ✓ Customize your analysis in content and appearance

## Barrier-free measurements

- ✓ Quickly familiarize yourself with our touchscreen GUI
- ✓ Adapt it to your own needs with a few clicks
- ✓ Enhance your screenshots with on-screen comments and sketches
- ✓ Add sensors using Plug'n'Measure

# The right channel combination for every application



Power analyzers are available in different accuracy classes, to allow the user to choose the right tool for the job at hand. After all, not all applications require maximum precision; often lower resolution and frequency range are sufficient. Unfortunately, not all measuring applications exhibit this distinction. It is very

well possible, for instance, to have need for different frequency ranges and accuracy levels at different points in the same measurement configuration. This is why the LMG600 offers three different channel types, which can be combined in the same chassis without problems to ensure that you always have a measuring device tailored to

your needs for your particular application. No need to accept trade-offs in accuracy or take a sledgehammer to crack a nut, if a lower priced solution could have served your purposes equally well.

## Best in class: The new S-Channel



- ✓ Superior AC & DC accuracy & stability
- ✓ Dedicated AC/DC ranges
- ✓ Automatic zero-adjustment
- ✓ Up to 1000 VAC, measurement category CAT III
- ✓ Up to 1500 VDC, measurement category CAT II

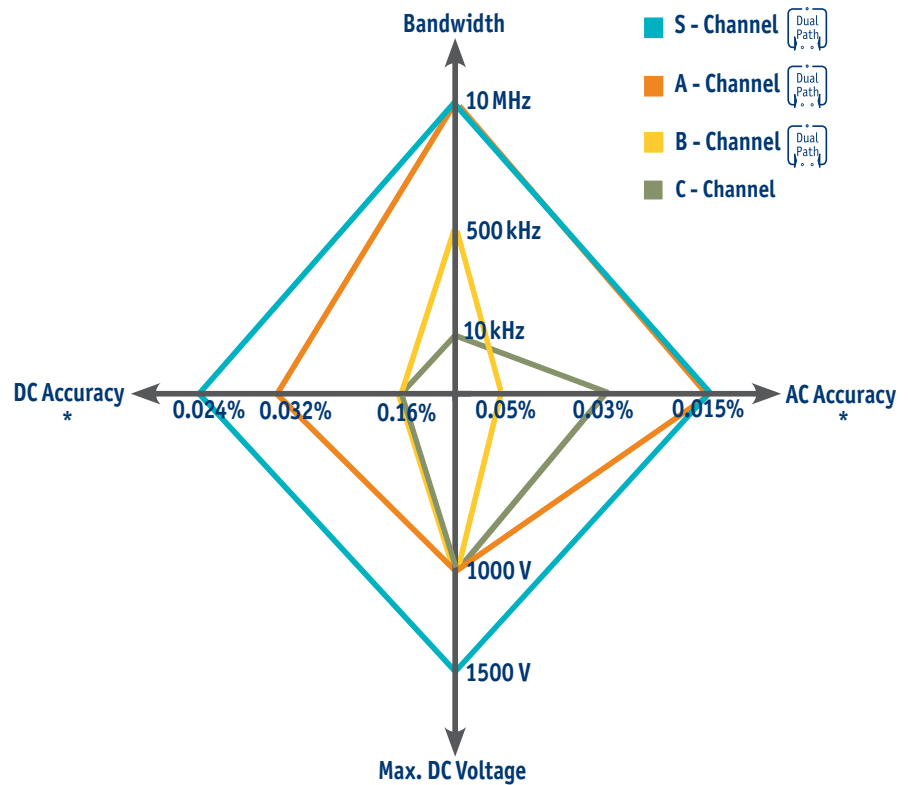

\* ± (% of measured value)

# Measuring in two bandwidths at the same time, thanks to DualPath - no compromises, no doubts

On conventional power analyzers, a signal undergoes analog conditioning, followed by optional anti-aliasing filters, before being fed into an A/D converter. The resulting signal can afterwards be used for the calculation of cycle-based RMS values. Alternatively it can serve as the base for an FFT or further digital filtering. Due to the limitation of using a single A/D converter, there are inherently some downsides to be factored

in with conventional devices. If measurements are carried out with filters active, in order to avoid aliasing with FFTs, then the wideband values are lost. With the filters switched off, strictly speaking, FFTs should not be used. If, in spite of this, FFTs are used without an anti-aliasing filter for measurements across the full frequency range, then the quality of the calculated values is questionable. An aliasing error of 50%, for

instance, is easily detected, however a deviation of 0.5% could go unnoticed. Ultimately, when you alternate filtered and non-filtered measurements, the validity of the results is equally in question, as this involves the assumption that the signal does not change over time, which is in practice hardly ever the case. In addition, this procedure is especially time consuming.

## LMG600

- ✓ Fast results
- ✓ Complete broadband values
- ✓ Correct FFT
- ✓ Precise results



### Conventional analyzers

- ⊖ Aliasing risk
- ⊖ Loss of broadband values
- ⊖ Waiving of FFT
- ⊖ Doubtful repeatability
- ⊖ Lengthy measurements





In the end, all of the measurement methods presented above are merely unsatisfactory compromises. This is why ZES ZIMMER has fundamentally redesigned signal processing and developed the DualPath architecture. The analog side is the same as in conventional measuring devices, however the subsequent digital processing has been revolutionized. The LMG600 is the first power analyzer to have two A/D converters in two independent signal paths for each current and voltage channel. One, for the filterless measurement of the wideband signal, and another, for the narrowband signal at the output of the anti-aliasing filter. The parallel processing of the digitized sample values gives the user access to both measurements of the same signal, without risking aliasing effects. This unique procedure avoids all of the downsides of previous approaches and guarantees the most precise result in the shortest time possible.

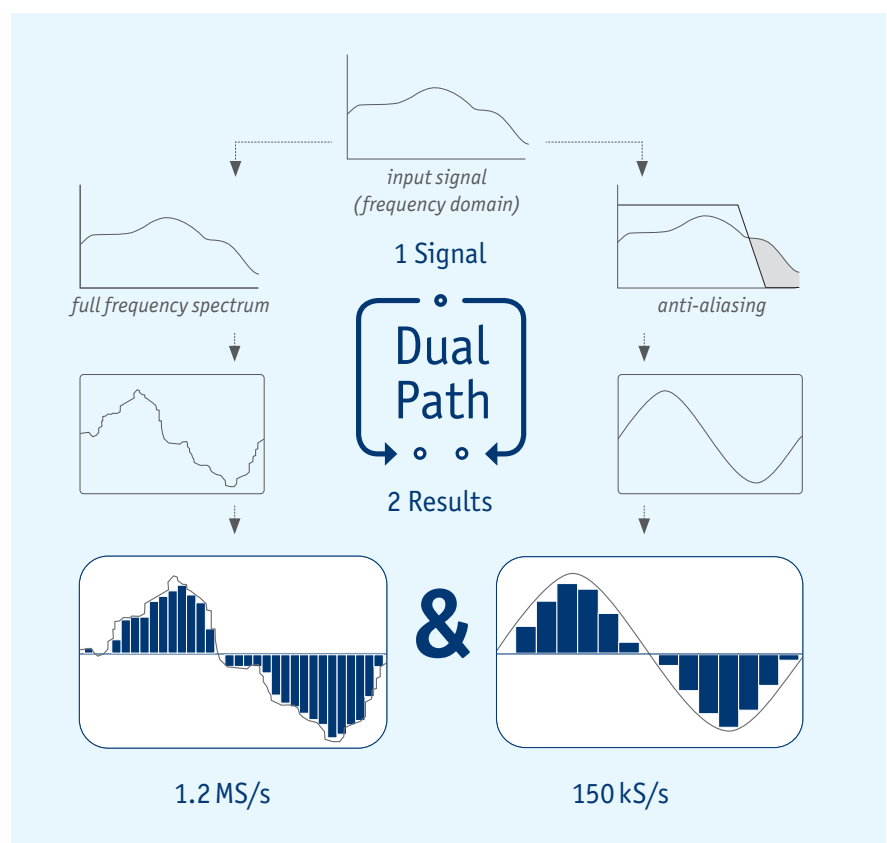

## Gapless/zero-blind measurement

In the course of stricter monitoring of the consumption and efficiency of electrical devices, new standards and procedures are continuously being introduced (e.g. SPECpower\_ssj2008, IEC 62301, EN 50564), in order to enable an impartial comparison of products from different manufacturers. Be it an office computer, server or household appliance, the same principle applies:

the procedure always requires long term analysis of the power consumption, taking into account all relevant operating conditions. The differences between minimum load - e.g. in standby - and full load can be of a significant magnitude, which makes precise measurement very challenging (see also application report no. 102 „[Measurement of standby power and energy](#)

[efficiency](#)“ at [www.zes.com](http://www.zes.com)). Some of the measurements required must be performed over several hours, yet without gaps. By selecting a sufficiently high measurement range, changing ranges and the inevitably associated losses in data can be avoided. The high basic accuracy of the LMG600 ensures precise measurement results, even near the lower limit of a range.

## Precise measurements thanks to minimal delay differences

The fast-switching semiconductors used in modern frequency converters to improve efficiency produce extremely steep voltage edges. The resulting capacitive currents put strain on the bearings and the insulation of the motors – this can lead to premature failure.

Motor filters (e.g.  $dU/dt$  filters) attenuate the steep voltage gradient, although they generate power losses themselves due to the transient oscillation with the filter's own frequencies (typically  $> 100$  kHz).

The broad frequency range and the minimal delay between current and voltage on the LMG600 allow extremely precise power loss measurements on the filters at these frequencies, including longitudinal measurements at low power factors. This also applies to power measurements with high frequency ranges of up to 10 MHz, which require the current and voltage channels to be designed for the smallest delay differences. On the LMG600 the offset is less than 3 ns, corresponding to a phase error  $< 1$   $\mu$ rad at

50 Hz. This makes the devices best suited to measure the power losses at low phase angles for transformers, chokes, capacitors and ultrasonic generators. No additional options or adjustments are required; the LMG600 is already fully capable of this measurement task with the standard factory settings. Usually current and voltage transducers are used for measurements on high-power circuits. The phase angle of these transducers can be corrected to improve measurement accuracy.

## Range extension with sensors? Plug 'n' Measure!

Although the LMG600 offers unmatched dynamic range, both for voltage and current, there are always applications with extraordinary requirements in terms of measurement ranges. Whether you are dealing with currents of several hundred amps or voltages of several kilovolts, ZES ZIMMER has the right solution at the ready. We offer a wide range of current and voltage sensors, which work perfectly in unison with the LMG600 precision power analyzer and extend the measurement ranges of the device by the required amount. The sensors of our Plug 'n' Measure series are equipped with a bus system, which enables automatic configura-

tion of the LMG600. This allows for all of the important parameters, such as the precise scaling factor, the delay compensation variable, the last calibration date, and the sensor type, to be read and used automatically by the power analyzer. Moreover, the sensors are actively supplied with power by the LMG600, separate power supplies are no longer required.

With Plug 'n' Measure there is no need for fine tuning by the user to improve the results. There is no difference between direct and sensor-supported measurements. Of course, other commercially available sensors can also be used with the LMG600.



Sensor Type PCT



# Powerful interfaces

In test bench environments, the power analyzer often must share its measurements with other existing computer and software environments.

As the high sampling rate of the LMG600 inevitably creates a large amount of data, we equipped it with a powerful Gigabit ethernet LAN interface to avoid bottlenecks. Even high-resolution measurements of all important parameters, such as current, voltage, active power, etc. over a period of several minutes or even hours can be rapidly transferred to a connected computer. In automotive environments CAN bus is widely used. By choosing the LMG600's CAN bus option, measurements can directly be shared over CAN, and the LMG600 can in turn act on data received over CAN (details on p.11).

Other interfaces are useful to connect peripheral devices for input or visual output. A USB 3.0 slot is available, and the LMG600 can also be equipped with a DVI interface to connect an external monitor or projector. Two more slots can be retrofitted for future interface standards.

The integrated sync interface allows to precisely synchronize multiple LMG600 with one another. It creates a common time base for measurements involving multiple LMG600 on the same system, or the mutual connection and control of an LMG600 by oscilloscopes or waveform generators.

The internal SSD of the LMG600 can store measured values, settings, user-defined measurement variables, or graphs for later use, even without having a PC connected. The firmware of the LMG600 can be quickly and easily updated via USB.



## Process signal interface (PSI)

### In-/Outputs

- ✓ 2 fast, synchronized analog inputs (ca. 150kS/s)
- ✓ 8 analog inputs
- ✓ 8 switching inputs (ca. 150kS/s)
- ✓ 2 torque-/speed-/frequency inputs
- ✓ 32 analog outputs
- ✓ 8 switching outputs

It is often necessary to take further measurements in addition to electrical parameters to be able to make a meaningful overall statement on the performance and efficiency of the device being tested. Hence, it is vital to be able to perfectly synchronize these measured values with the RMS values calculated by the LMG600, in order to establish reliable timing between electrical and mechanical events. A typical application is the analysis of electrical drive systems, where torque and speed must be measured and reconciled with the

electrical parameters. Conversely, it may also be necessary for the power analyzer to output results as analog signals for further processing, or to trigger switching operations depending on measured variables or derived values. In order to be equipped for all of these potential requirements, the LMG600 offers a multitude of different input/output features for analog and digital signals.

# Star-to-delta conversion

In three-phase three-wire systems, only the line-to-line voltages  $U_{12}$ ,  $U_{23}$ ,  $U_{31}$  and the line currents  $I_1$ ,  $I_2$ ,  $I_3$  are accessible for measurement. With the star-to-delta conversion option, the line-to-line voltages can be converted to non-accessible phase voltages and the related active power can be determined. Likewise the line currents can be converted into the phase currents. From these calculated values it is possible to derive all other variables, such as

harmonics. Distortions and imbalances of the grid or consumers are properly taken into account. This makes the use of an external, artificial neutral point superfluous;

although one could use such at any time, provided that the associated disadvantages (e.g. increased power losses) are taken into account.

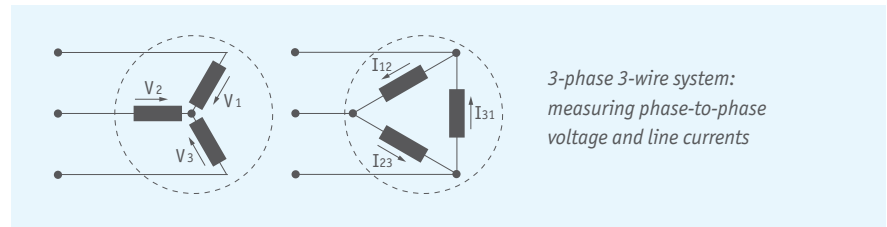

# Easy to use – with or without touchscreen

To ensure that the LMG600 can be used in all conditions, particular attention has been paid to universal usability. All display modes and setting options can be operated both by the touchscreen or the keypad, without exception. The optimized design consistently links the keypad to the associated views and setting options on the screen. To use the instrument effectively requires almost no familiarization. The graphical user interface directs the user without detours to the required values. Be it RMS of voltage or current, associated harmonics or cumulative

values, these are usually only a single press of a button away. In addition, user-defined views allow to group individually measured values, so that all the parameters are always available at a glance. This ergonomic way of operation and the associated time savings contribute directly to the productive use of the LMG600. The eight context-specific double softkeys to the right of the display, whose function always corresponds to their on-screen counterparts on the right-hand side, are especially important for ease-of-use. One can determine the function as-



signed to a given softkey at a glance. The double softkey design enables the respective parameter to be rapidly configurable; switching through views that are not relevant is no longer necessary. Should there be questions about function and control while operating the device, the relevant sections of the manual can be displayed at any time.



*Simultaneous measurement of narrowband and wideband values*



*Superimposed help text from manual*



*Plot of measured RMS values*



*Display of sampling values of 16 signals in two scopes*

# Everything important just a click away



Click on softkey <Display> to toggle between RMS values and harmonics

Click on softkey <Phase-Ch> to display measured values for all channels or linked values in a group



Click on Cycle to set the duration and the reference of the measurement cycle

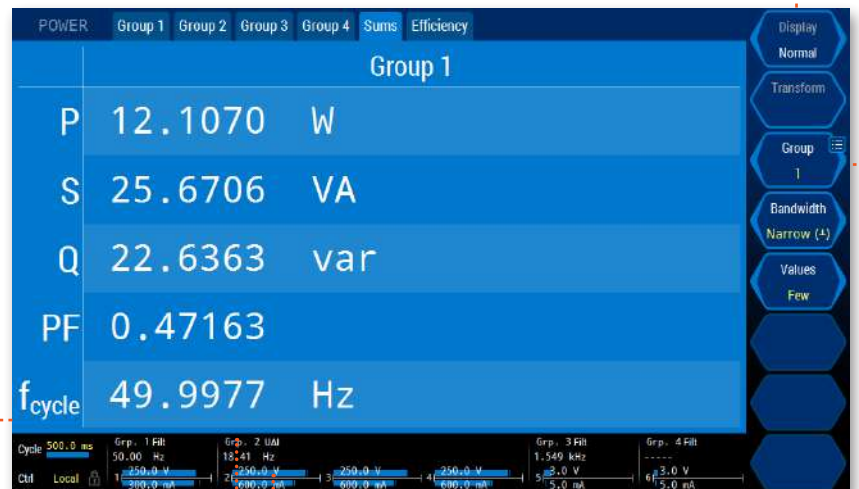

Click on the group to change the signal, harmonics and synchronization settings

Click on the level indicator to configure the channel-specific measurement ranges and sensor settings





# Capturing important events on scope

Steady-state measurements are making up a considerable portion of power analyzers' everyday use scenarios. Still, it is often the unpredictable events that give design engineers a headache. Reliable detection of transient conditions imposes heavy demands on the instruments used.

Whenever supreme accuracy, low measurement ranges, direct current measurement and robust electrical isolation are required, oscilloscopes and transient recorders have to cede to power analyzers.

ZES ZIMMER's LMG600 series power analyzers can be equipped with the Event Trigger software option (L6-OPT-EVT) to monitor voltage and current signals for unique conditions. Those conditions can be characterized by upper and lower bounds of the sample values, which can also be combined to define signal windows for triggering.

After trigger conditions have been set, ZES ZIMMER's Trigger View offers a convenient way to verify the correctness of the settings. Trigger View visualizes the effects of settings like sync filters and level or hysteresis

and displays the resulting trigger signal. Once the defined conditions are violated for the minimum duration chosen by the customer, recording is activated. The length of the recording can be chosen by the user, with 16 tracks at 16MS (LMG670: 4MS) each available for storage. The recorded samples are available graphically on the LMG600's scope in a separate tab, or numerically via the data interfaces for further analysis. Using the event trigger function has no impact on cycle based power measurements carried out in parallel on the same channel.

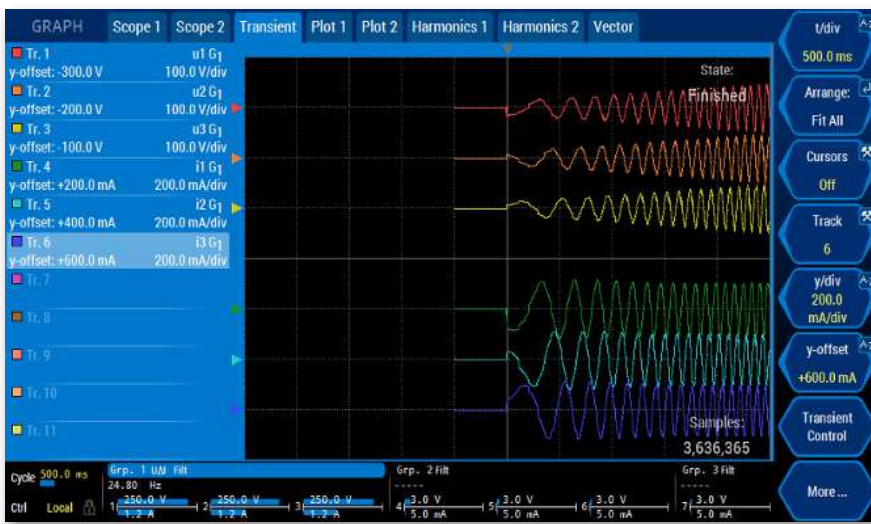

Screenshot of Event Trigger option with up to 16 million samples. The Scope View offers a quick and convenient way to visualize signals in the time domain. The viewer for the Event Trigger allows you to display the behavior of voltage, current, power or other variables in 16 tracks from different channels in graphical form and with a variable time base. Cursors can be used to mark segments or measure differences of time and amplitude between two points. The reciprocal value of the time difference (i.e. frequency) is also provided. Further analysis of the samples can be performed on PC using the LMG Sample Vision software.

# Synchronization - no need to stop at 7 channels

The LMG600 series already offers the highest channel count per chassis in the power analyzer market, yet there are applications which require 8 or more points of power measurement. The solution is simple: combine multiple LMG600 chassis' to create a virtual power analyzer with more channels. All you need to do is to connect the individual units via sync cable, and they will automatically synchronize:

- ✓ cycle timing
- ✓ system time
- ✓ transient trigger events
- ✓ state of energy integration

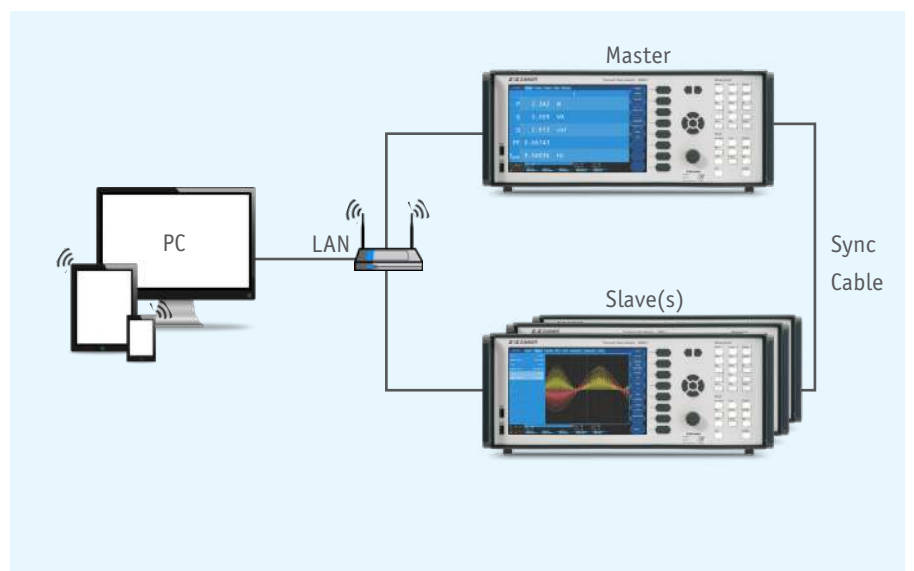

# Bi-directional CAN interface – remote control via CAN

In many test setups involving power analysis, the majority of the data to be evaluated will come from the power analyzer itself. The automotive environment, however, typically differs a lot. Modern cars can be equipped with hundreds of electronic control units (ECUs) and sensors of different kinds. Within the sea of data points these devices generate, voltage, current and power values are just a minor subset. Nevertheless, this subset needs to be integrated with the remainder of the data for the test engineers to benefit from it.

While ECU and sensor data typically get exchanged over the CAN bus, traditional power analyzers communicate via GPIB or Ethernet. Thus, it is up to the test engineers to reconcile data from both sources and to put it in a common format in order to correlate it. This is no mean feat, as there is usually no common time basis between the CAN data and the values provided by the power analyzer, and matching electrical parameters to other sensor data is very challenging. In any case, there is a lot of manual intervention involved, and the procedure is cumbersome, lengthy and error-prone.

The LMG600 is the only dedicated power analyzer in the world that is able to share up to 128 values and variables over CAN bus. This unique capability helps to bridge the gap between the automotive industry's most popular field bus and traditional test & measurement equipment. Test engineers can now read voltage, current, power etc. the same way they read speed, torque, temperature and other variables: by gathering data from sources on the CAN bus. No sep-

arate treatment, no extra work, no distinct data repositories. The necessary time to integrate power measurements into the overall test environment shrinks drastically. The need for additional middleware is eliminated, costs are contained at the necessary minimum. With the latest firm-

This feature offers a convenient way to e.g. trigger data logging based on environmental conditions or change measuring ranges according to the state of the unit under test. Imagine you would like to initiate logging data once a critical temperature threshold is exceeded at a certain location. To imple-

Slot	CAN Id	EFF Bit	Measurand	Status
1	15	Off	P1 G1	ON
2	16	On	U <sub>term1</sub> G1	ON
3	17	Off	I <sub>term1</sub> G1	ON
4	18	On	Ih1 G1 (1)	ON
5	19	Off	EP1 G1	ON
6	20	Off	PF1 G1	ON
7	21	Off	PSIM <sub>TRIP0E</sub>	ON
8	22	On	PSIM <sub>TRIPES</sub>	ON
9	23	Off	Transient 0, (1)	ON

Define the measurands sent to CAN bus

LMG triggers on data or commands from CAN bus and executes actions (e.g. starts a log)



LMG sends measurands to CAN bus



ware release, the LMG600 can also read information sent over the CAN bus and carry out a number of predefined actions based on its content. That is, the CAN bus interface of the power analyzer has become bi-directional, changing it from a purely passive sensor to a remote-controllable analysis tool.

ment this procedure you simply would have the LMG600 read the information sent by the respective temperature sensor over CAN and set a trigger condition accordingly. Once the temperature has risen above the limit, recording starts automatically. Likewise, switching an electrical engine off via CAN could simultaneously trigger a range change in the power analyzer, avoiding the otherwise necessary settling period of the auto-ranging mechanism. The LMG600 allows to define up to 128 trigger conditions to cover automation of even the most sophisticated measurement and recording tasks.

Id	EFF	Offset	Bit Length	Op. Type	Condition	Ref. Value	State
10	Off	0	8	INTEGER	GREATER	28	ON
1	Action: logonce						
11	Off	0	8	INTEGER	GREATER	28	ON
2	Action: logonce						
0	On	0	0	INTEGER	NEQUAL	0	OFF
3	Action:						
0	Off	0	0	INTEGER	NEQUAL	0	OFF

Define actions for the LMG for incoming data of the CAN bus

# Testing without disruption – five in one

In a typical test scenario, the way from raw signals to the final pass/fail indication is a long and winding path stretching over five distinct phases. Computing RMS power is only one piece of the puzzle, and data from other sources might need to be integrated into the calculations. This can lead to a complex assortment of data sources and processing tools with many handover points. The discontinuities in the flow of data may require manual intervention, which demands time and effort and increases the risk of introducing errors.

The LMG671 is designed to combine all five phases of testing into a single instrument, thus eliminating unnecessary complexity, streamlining the testing process, making test engineers' life easier and keeping cost down.

1. **Signal acquisition:** the LMG671 goes beyond voltage and power. The versatile Process Signal Interface (PSI) can read virtually any analog or digital signal source, thus allowing e.g. temperature, pressure, speed, torque and other data to be collected together with voltage and current. No need to reconcile data points from different sources later on, no issues with inconsistent timestamps between variables.

2. **Timing control:** for the test results to be meaningful, the DUT needs to be observed in specific, predefined modes of operation. The LMG671 can control beginning and end of the measurements via the versatile Event Trigger option. In addition, it can react to external trigger inputs or CANbus commands to start recording data. The LMG671 can also control external devices via a number of analog and digital outputs in the optional PSI.

3. **Integration:** to calculate RMS voltage, current and power as well as harmonic values, the samples need to be summed over entire signal periods – this is the traditional domain of power analysis. (Outsourcing the calculation to PC environments already at this step renders the

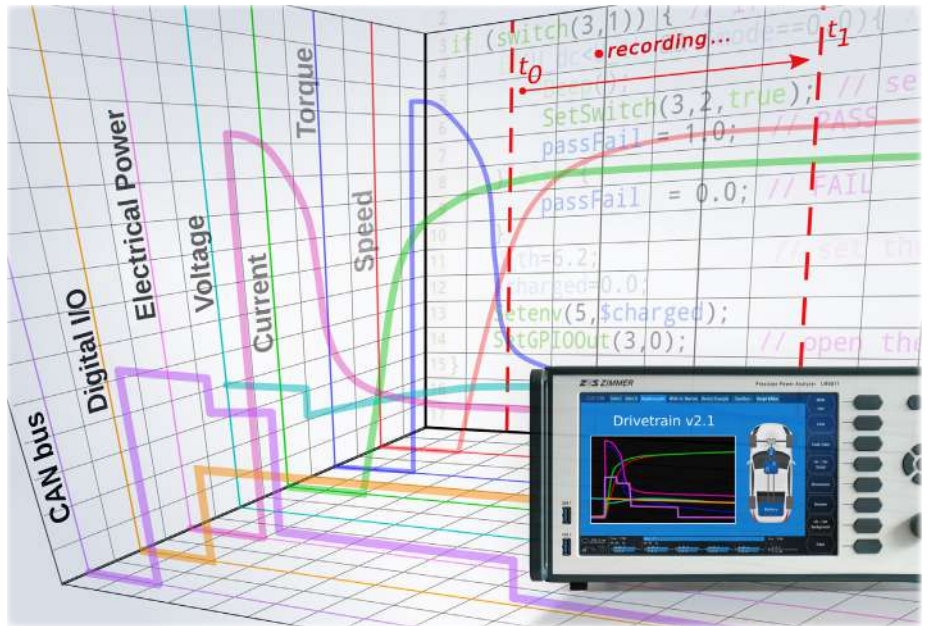

integrity of RMS values and harmonics vulnerable and makes calibration of the setup rather difficult.)

4. **Derivation:** in many applications, the measurement of electrical quantities is just a means to an end and not the final goal. An illustrative example is the qualification of inductive components: measuring voltage and current ultimately yields core losses and the peak values of magnetic field strength and flux density. Rather than exporting electric measurements to 3rd party applications for the calculation of the desired results, the LMG671 offers a powerful built-in programming language with a vast number of mathematical functions to carry out all required calculations in one fell swoop. No handover, no disruptions, no risk of additional errors.

5. **Pass/fail decision:** In case the DUT is tested against defined standards or previously established benchmarks, the pass/fail limits can be programmed into the LMG671 in order to allow the instrument to display the outcome of the test directly. Should there be different pass/fail criteria for consecutive DUTs, applicable limits can even be adjusted on-screen by the test engineer use the touchscreen GUI's input boxes or arrow keys. Some tests

require additional information (like e.g. magnetic path length, core diameter etc.) on the DUT that varies between tests and also needs to be considered for calculation. Also this kind of data can be entered and changed directly on-screen using a number of available input elements. These built-in decision-support features allow even less experienced or less well-trained users to reliably judge success or failure of the test.



### Environment variables

In the example above, power P1 is compared to environment variable 1, which can be adjusted on-screen using the depicted arrow softkeys.

### Signals

The values assumed by environment variables can be color-coded to alert the user to the status of the DUT or to indicate the outcome of the measurement e.g. pass/fail.

### Switching keys

The status of the softkeys can be queried by the script. Those keys can act as push button, toggle or latching switches.



# Five in one example: automated magnetic core testing

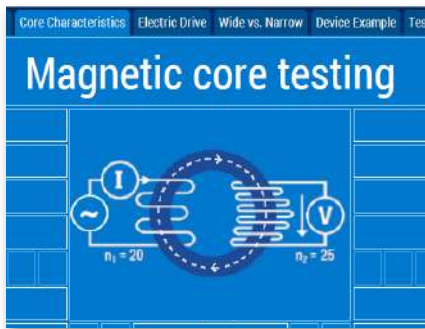

Magnetic Flux Density:  
 $B_{pk} = 0.60800 \text{ T}$   
 Magnetic Field Strength:  
 $H_{pk} = 175.4024 \text{ A/m}$

```

25 //Characteristics and loss
26 Pfe = p1111?*$n1/$n2 //Power
27 Bpk = urec1111?/(4*fcyc111
    magnetic flux density
28 Hpk = Ipk*$n1/$lmagn // pe
29 ua = Bpk/0.0000012566/Hpk
    permeability
    
```

In this example the magnetic field strength and flux density from voltage, current and frequency measurements are calculated. The script editor offers a vast variety of mathematical, logical and procedural programming functions like loops and conditional execution of commands.

Make it easier to recognize your application: Add a meaningful title for your measurement. Use graphical elements like drawings or photographs to depict your setup and freely arrange them. Add your brand logo and reflect your corporate style in the choice of colors and design elements.

Sometimes, the formulae stored in the script editor require additional input, e.g. parameters that vary with every individual DUT, like material constants. No need to edit the stored scripts – these parameters can easily be entered on-screen by the executing engineer during testing. Arrow soft keys allow for in-/decrementing the chosen variables, and the number can be entered directly as well.

$n_{prim}$ : 20.0  
 $n_{sec}$ : 25.0  
 Cross section: 6.5 m  
 Magn. Path length: 100.0 m

Add measurement values you are interested in, and only show what you need. You can display any electric quantity measured by the power channels as well as values from any I/O interface (CAN, PSI, GPIO).

Primary Current:  
 $I_{prim} = 20.753 \text{ mA}$

Pass or fail criteria can be established in order to judge the suitability of the DUT for its intended purpose. The LMG600 allows to automate this decision based on the measured and calculated properties. The results of the test can be displayed in easily readable form to allow less skilled users to carry out testing without additional supervision.

Passed █



# Clear visualization of measurements thanks to groups

The power channels can be organized in groups that define their role in the current measurement application. The groups appear almost as virtual measurement channels or virtual devices in addition to the physical channels. The logical grouping of the P-channels is dependent on the number of wires and phases of the electrical system being analyzed. Thanks to the flexibility of the LMG600, it is possible to model even unusual and rarely seen configurations, such as split-phase systems and four-phase systems or multiphase systems.

The only requirement is that all of the channels within a group have the same basic frequency and are of the same type (A, B, C). This will avoid subtle errors, which arise due to the different technical properties of the different channel types. One benefit of creating groups is that it makes configuring the device easier, since filter settings (for example) affecting all channels in the group only have to be configured once. In addition, derived values, such as active, apparent or idle power are calculated across all channels in the group. While grouping

specifies how the channels are combined logically, the wiring dictates how the inputs of the measuring device are connected to the measuring circuit, i.e. whether it is a star-to-delta circuit or whether there are neutral wires, etc. The wiring defines how the measured signals are interpreted by the device.

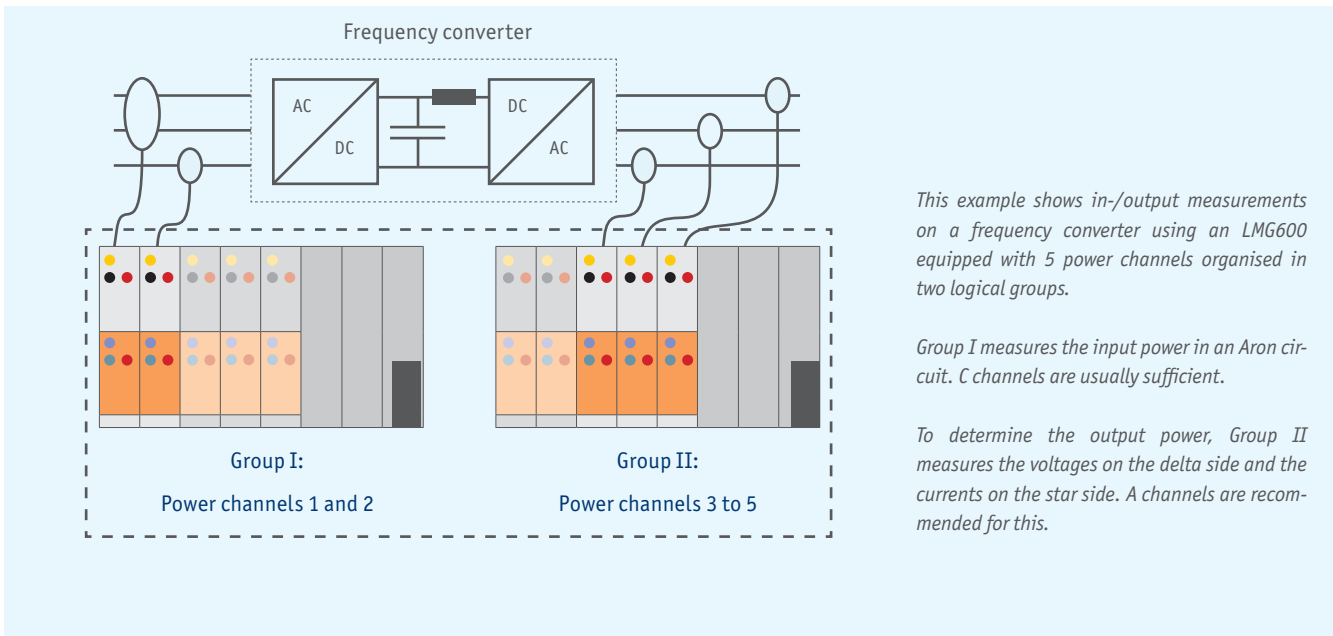

This example shows in-/output measurements on a frequency converter using an LMG600 equipped with 5 power channels organised in two logical groups.

Group I measures the input power in an Aron circuit. C channels are usually sufficient.

To determine the output power, Group II measures the voltages on the delta side and the currents on the star side. A channels are recommended for this.



This screenshot depicts an example for logical grouping of an LMG600 fitted with 7 power channels, e.g. for measuring an electric drive. Group 1 & 2, with three channels each, could comprise the 3-phase input/output connections, while the single-channel Group 3 might represent the DC link.

LMG600 with 7 power channels organised in 3 groups

# Electrical drive systems

More than half of the electrical energy generated worldwide is converted to mechanical motion, and the importance of electric powertrains for transport of goods and people is growing steadily. While outdated speed controllers are afflicted with losses of up to 40%, modern, frequency-controlled systems can achieve efficiency levels of over 95%. These frequency converters use pulse

width modulation to control the speed of the motor with hardly any losses. The objective is to optimally adjust the converter and motor to one another, in order to achieve the best overall efficiency. Measuring the input power, the intermediate circuit, and the output power of the converter as well as the mechanical power of the motor simultaneously is anything but trivial. In addition to

the integration of sensor technology (wide-band sensors for high currents, high-voltage dividers, precise speed and torque transmitters), the instrument must meet the challenge of measuring the very steep-flanked signals at the converter output. This environment is often described as harsh, not merely from an EMC point of view.

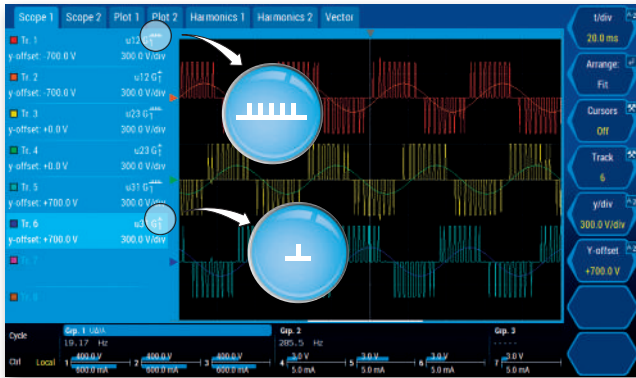
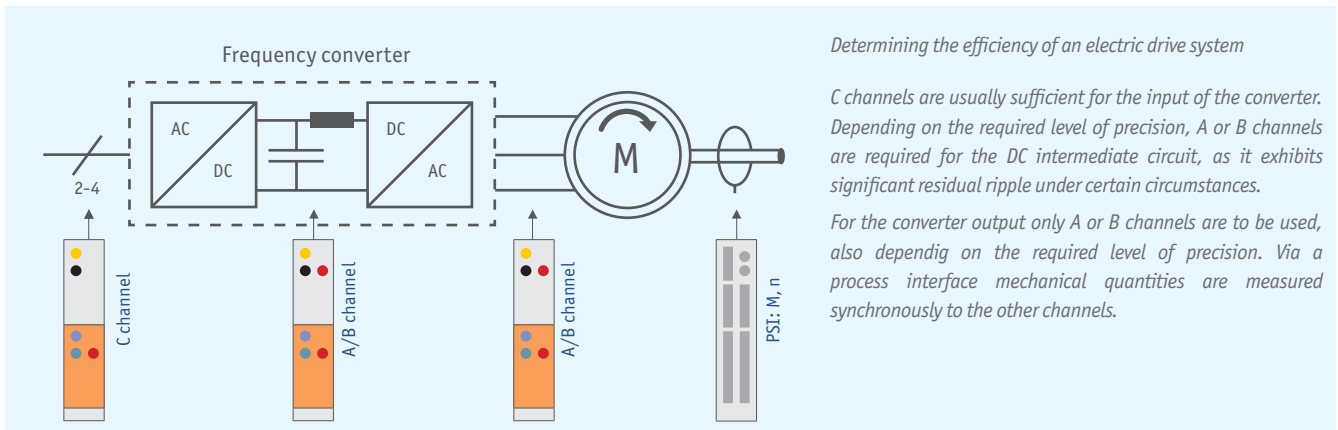

and another one on a filtered signal to determine the power at certain frequencies, resp. a subsequent FFT analysis to measure the harmonic spectrum. This procedure is very time-consuming, yet it cannot guarantee that the conditions present during the initial measurement still prevail during the repetition.

The innovative DualPath architecture of the LMG600 provides all of the required results simultaneously in a single measurement, with maximum precision, and the widest frequency range on the market – free from aliasing effects.

Of course the key question in the analysis of electrical drive systems is: which part of the electrical energy at the converter output relates to the torque-relevant fundamental frequency of the motor, and which part to

the remaining frequency range, particularly the harmonic spectrum? To give an accurate answer, it has long been necessary to perform two separate measurements: one without filters to establish the wideband power,

## CHALLENGES

- Synchronous measurement of speed and torque
- Highly accurate measurement of the fundamental oscillation relevant to torque
- Simultaneous aliasing-free measurement of losses across maximum frequency range
- Range expansion for high current and medium voltage applications
- Fast data export to third-party devices and applications

- ✓ DualPath
- ✓ Accuracy
- ✓ A/B/C Channels
- ✓ Immunity
- ✓ Harmonics
- ✓ Interfaces
- ✓ Star-to-Delta
- ✓ Plug 'n' Measure

# EV chargers testing and certification

A precise power measuring instrument like the LMG600 series power analyzer can be seamlessly integrated into compliance test benches by charging station manufacturers and certifying institutions. It can serve as a traceable standard for type examination certification and is an excellent tool for verifying proper charging functioning in case of any doubts. Charging stations are equipped with a single or multiple charging plugs of type 2, CCS, CHAdeMO or other to provide AC and/or DC charging. Integrated certified energy meters for each charging plug measure the energy consumed for the complete charging process. The meter communicates its reading to the system back-

end for billing purposes. The voltage and current signals are fed into the power analyzer via breakout boxes. Voltage drops that may occur are typically negligibly small. For AC type 2 charging plugs, the current must not exceed 32 A and can directly be connected to the power analyzer's inputs. Particularly fast DC charging results in current values of several 100 A which require a very accurate current sensor, like the PCT sensor with its outstanding Flux-Gate technology. Additionally, the energy meter's pulse output is connected to the LMG671 process-signal-interface (PSI) switching input, allowing the analyzer to capture the pulses during the complete charging pro-

cess to determine the energy metered by the charging station. The type examination test procedure specifies a measurement over a minimum number of leaps of the lowest value digit, which corresponds to a minimum number of pulses. This number depends on the device to be charged and the point of operation chosen. The higher the charging power, the higher the prescribed minimum number of pulses. Otherwise, the observed time window will be too short, and the uncertainty of the internal clock will have an undue influence on observed measurement accuracy.

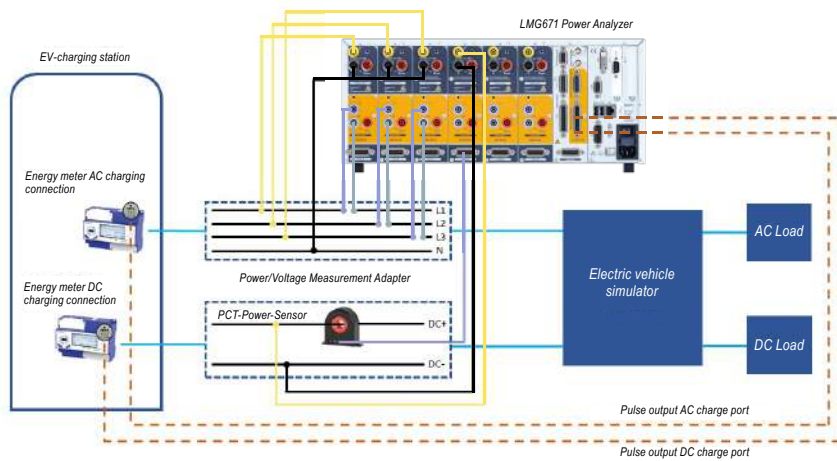

Measuring setup with LMG671 and PCT current sensor

The module B, respectively EU-type examination test for certification, stipulates to verify the accuracy of the complete charging process by comparing the energy metered at each charging port with the energy measured by a reference instrument.

This can be a precise power analyzer like the LMG671 wired between the energy meter and electric vehicle.

The figure on the left side shows a possible measuring setup with an LMG671 power analyzer as reference instrument.

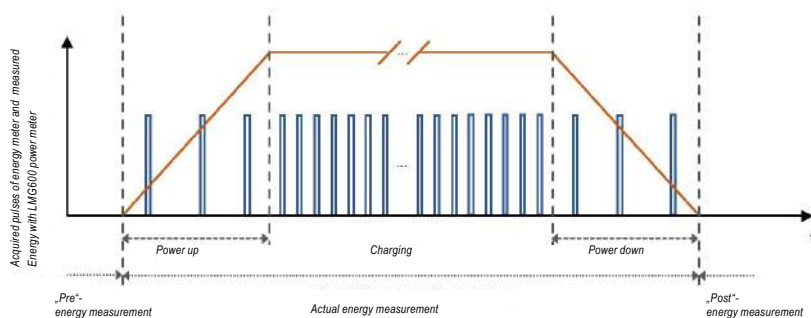

Energy meter pulses captured and energy measured by the LMG600 power analyzer

The LMG671 switching inputs are sampled with 150 kHz. Standardized energy meter pulse signals will be reliably captured and counted.

Depending on the charging power level and specified pulses per kilowatt-hour of the integrated energy meter, the fastest measuring cycle time of 10 ms (or 20 ms considering a 50 Hz signal) allows to count the pulses captured almost one by one.

This is important to ensure the number of captured pulses during the energy integration interval is accurate.

# Accuracy specification

S channel Accuracy	± (% of measured value + % of maximum peak value)
	DC <sup>3)</sup>
Voltage U*	0.02+0.04
Voltage U <sub>SENSOR</sub>	0.02+0.04 <sup>4)</sup>
Current I* 5 mA...5 A range AC, 10 mA...8 A range DC	0.02+0.04
Current I* 10 A...32 A range AC, 15 A...32 A range DC	0.02+0.1 <sup>5)</sup>
Current I <sub>SENSOR</sub>	0.02+0.04 <sup>4)</sup>
Active Power	$\Delta P_{DC} = \pm( \Delta U_{DC} \cdot I_{DC}  +  \Delta I_{DC} \cdot U_{DC} )$ Description of the used formula symbols, see ACCURACY SPECIFICATIONS in the manual

<sup>3)</sup> Accuracy specification is valid with activated automatic zero adjustment, max. 24 h after last change of the measuring range in the current measurement channel at jack I\*, temperature change after change of the measuring range max. ±1 °C, max.30 days after persistent zero adjustment in the voltage measurement channel at the jacks U\* and Usensor and in the current measurement channel at jack Isensor (see ZERO ADJUSTMENT in the manual)

<sup>4)</sup> Accuracy specification is valid with activated signal filter 15 kHz or 150 kHz

<sup>5)</sup> Additional accuracy specification in the 10 A ... 32 A range AC or 15 A ...32 A range DC:  $\pm \frac{80 \mu A}{A^2} \cdot I_{rms}^2$

S channel Accuracy									
	0.05 Hz ... 45 Hz 65 Hz ... 3 kHz	45 Hz ... 65 Hz	3 kHz ... 10 kHz	10 kHz ... 50 kHz	50 kHz ... 100 kHz	100 kHz ... 500 kHz	500 kHz...1 MHz	1 MHz ... 2 MHz	2 MHz ... 10 MHz
Voltage U*	0.015+0.03	0.01+0.02	0.03+0.06	0.2+0.4		0.5+1.0	0.5+1.0	f/1MHz*1.5 + f/1MHz*1.5	
Voltage U <sub>SENSOR</sub>	0.015+0.03	0.01+0.02	0.03+0.06	0.2+0.4		0.4+0.8	0.4+0.8	f/1MHz*0.7 + f/1MHz*1.5	
Current I* 5 mA...5 A range AC, 10 mA...8 A range DC	0.015+0.03	0.01+0.02	0.03+0.06	0.2+0.4		0.5+1.0	0.5+1.0	f/1 MHz*1.0 + f/1 MHz*2.0	-
Current I* 10 A...32 A range AC, 15 A...32 A range DC	0.015+0.03 <sup>3)</sup>	0.01+0.02 <sup>3)</sup>	0.1+0.2 <sup>3)</sup>	0.3+0.6 <sup>3)</sup>	f/100 kHz*0.8 + f/100 kHz*1.2 <sup>3)</sup>		-	-	-
Current I <sub>SENSOR</sub>	0.015+0.03	0.01+0.02	0.03+0.06	0.2+0.4		0.4+0.8	0.4+0.8	f/1 MHz*0.7 + f/1 MHz*1.5	
Power U*/I* 5 mA...5 A range AC, 10 mA...8 A range DC	0.024+0.03	0.015+0.01	0.048+0.06	0.32+0.4		0.8+1.0	0.8+1.0	f/1MHz*2.0 + f/1MHz*1.8	-
Power U*/I* 10 A...32 A range AC, 15 A...32 A range DC	0.024+0.03 <sup>3)</sup>	0.015+0.01 <sup>3)</sup>	0.104+0.13 <sup>3)</sup>	0.4+0.5 <sup>3)</sup>	f/100 kHz*0.8 + f/100 kHz*0.8 <sup>3)</sup>	f/100 kHz*1.0 + f/100 kHz*1.1 <sup>3)</sup>	-	-	-
Power U*/I <sub>SENSOR</sub>	0.024+0.03	0.015+0.01	0.048+0.06	0.32+0.4		0.72+0.9	0.72+0.9	f/1 MHz*1.8 + f/1 MHz*1.5	
Power U <sub>SENSOR</sub> /I* 5 mA...5 A range AC, 10 mA...8 A range DC	0.024+0.03	0.015+0.01	0.048+0.06	0.32+0.4		0.72+0.9	0.72+0.9	f/1 MHz*1.4 + f/1 MHz*1.8	-
Power U <sub>SENSOR</sub> /I* 10 A...32 A range AC, 15 A...32 A range DC	0.024+0.03 <sup>3)</sup>	0.015+0.01 <sup>4)</sup>	0.104+0.13 <sup>3)</sup>	0.4+0.5 <sup>3)</sup>	f/100 kHz*0.8 + f/100 kHz*0.8 <sup>3)</sup>	f/100 kHz*1.0 + f/100 kHz*1.0 <sup>3)</sup>	-	-	-
Power U <sub>SENSOR</sub> /I <sub>SENSOR</sub>	0.024+0.03	0.015+0.01	0.048+0.06	0.32+0.4		0.64+0.8	0.64+0.8	f/1 MHz*1.1 + f/1 MHz*1.5	

<sup>3)</sup> Additional accuracy specification in the 10 A ... 32 A range AC or 15 A ...32 A range DC:  $\pm \frac{80 \mu A}{A^2} \cdot I_{rms}^2$

<sup>4)</sup> Additional accuracy specification in the 10 A ... 32 A range AC or 15 A ...32 A range DC:  $\pm \frac{80 \mu A}{A^2} \cdot I_{rms}^2 \cdot U_{rms}$



# Accuracy specification

A channel Accuracy	± (% of measured value + % of maximum peak value)										
	DC	DC <sup>e)</sup>	0.05 Hz ... 45 Hz 65 Hz ... 3 kHz	45 Hz ... 65 Hz	3 kHz ... 10 kHz	10 kHz ... 50 kHz	50 kHz ... 100 kHz	100 kHz ... 500 kHz	500 kHz ... 1 MHz	1 MHz ... 2 MHz	2 MHz ... 10 MHz
Voltage U*	0.02+0.08	0.02+0.06 <sup>e)</sup>	0.015+0.03	0.01+0.02	0.03+0.06	0.2+0.4		0.5+1.0	0.5+1.0	f/1 MHz*1.5 + f/1 MHz*1.5	
Voltage U <sub>SENSOR</sub>	0.02+0.08	0.02+0.06 <sup>e)</sup>	0.015+0.03	0.01+0.02	0.03+0.06	0.2+0.4		0.4+0.8	0.4+0.8	f/1 MHz*0.7 + f/1 MHz*1.5	
Current I* 5 mA...5 A	0.02+0.1	0.02+0.06 <sup>e)</sup>	0.015+0.03	0.01+0.02	0.03+0.06	0.2+0.4		0.5+1.0	0.5+1.0	f/1 MHz*1.0 + f/1 MHz*2.0	-
Current I* 10 A...32 A	0.02+0.1 <sup>1)</sup>	-	0.015+0.03 <sup>3)</sup>	0.01+0.02 <sup>3)</sup>	0.1+0.2 <sup>3)</sup>	0.3+0.6 <sup>3)</sup>	f/100 kHz*0.8 + f/100 kHz*1.2 <sup>3)</sup>		-	-	-
Current I <sub>SENSOR</sub>	0.02+0.08	0.02+0.06 <sup>e)</sup>	0.015+0.03	0.01+0.02	0.03+0.06	0.2+0.4		0.4+0.8	0.4+0.8	f/1 MHz*0.7 + f/1 MHz*1.5	
Power U*/I* 5 mA...5 A	0.032+0.09	0.032+0.06 <sup>e)</sup>	0.024+0.03	0.015+0.01	0.048+0.06	0.32+0.4		0.8+1.0	0.8+1.0	f/1 MHz*2.0 + f/1 MHz*1.8	-
Power U*/I* 10 A...32 A	0.032+0.09 <sup>3)</sup>	-	0.024+0.03 <sup>4)</sup>	0.015+0.01 <sup>4)</sup>	0.104+0.13 <sup>4)</sup>	0.4+0.5 <sup>4)</sup>	f/100 kHz*0.8 + f/100 kHz*0.8 <sup>4)</sup>	f/100 kHz*1.0 + f/100 kHz*1.1 <sup>4)</sup>	-	-	-
Power U*/I <sub>SENSOR</sub>	0.032+0.08	0.032+0.06 <sup>e)</sup>	0.024+0.03	0.015+0.01	0.048+0.06	0.32+0.4		0.72+0.9	0.72+0.9	f/1 MHz*1.8 + f/1 MHz*1.5	
Power U <sub>SENSOR</sub> /I*	0.032+0.09	0.032+0.06 <sup>e)</sup>	0.024+0.03	0.015+0.01	0.048+0.06	0.32+0.4		0.72+0.9	0.72+0.9	f/1 MHz*1.4 + f/1 MHz*1.8	-
Power U <sub>SENSOR</sub> /I* 10 A...32 A	0.032+0.09 <sup>3)</sup>	-	0.024+0.03 <sup>4)</sup>	0.015+0.01 <sup>4)</sup>	0.104+0.13 <sup>4)</sup>	0.4+0.5 <sup>4)</sup>	f/100 kHz*0.8 + f/100 kHz*0.8 <sup>4)</sup>	f/100 kHz*1.0 + f/100 kHz*1.0 <sup>4)</sup>	-	-	-
Power U <sub>SENSOR</sub> /I <sub>SENSOR</sub>	0.032+0.08	0.032+0.06 <sup>e)</sup>	0.024+0.03	0.015+0.01	0.048+0.06	0.32+0.4		0.64+0.8	0.64+0.8	f/1 MHz*1.1 + f/1 MHz*1.5	

B channel Accuracy	± (% of measured value + % of maximum peak value)						
	DC	0.05 Hz ... 45 Hz 65 Hz ... 1 kHz	45 Hz ... 65 Hz	1 kHz ... 5 kHz	5 kHz ... 20 kHz	20 kHz ... 100 kHz	100 kHz ... 500 kHz
Voltage U*	0.1+0.1	0.1+0.1	0.03+0.03	0.2+0.2	0.3+0.4	0.4+0.8	f/100 kHz*0.8 + f/100 kHz*1.2
Current I* 5 mA...5 A Current I <sub>SENSOR</sub>	0.1+0.1	0.1+0.1	0.03+0.03	0.2+0.2	0.3+0.4	0.4+0.8	f/100 kHz*0.8 + f/100 kHz*1.2
Current I* 10 A...32 A	0.1+0.1 <sup>1)</sup>	0.1+0.1 <sup>3)</sup>	0.03+0.03 <sup>3)</sup>	0.2+0.2 <sup>3)</sup>	0.6+1.2 <sup>3)</sup>	1.5+1.5 <sup>3)</sup>	f/100 kHz*2.0 + f/100 kHz*2.0 <sup>3)</sup>
Power U*/I* 5 mA...5 A Power U*/I <sub>SENSOR</sub>	0.16+0.1	0.16+0.1	0.05+0.02	0.32+0.2	0.48+0.4	0.64+0.8	f/100 kHz*1.28 + f/100 kHz*1.2
Power U*/I* 10 A...32 A	0.16+0.1 <sup>2)</sup>	0.16+0.1 <sup>4)</sup>	0.05+0.02 <sup>4)</sup>	0.32+0.2 <sup>4)</sup>	0.72+0.8 <sup>4)</sup>	1.52+1.15 <sup>4)</sup>	f/100 kHz*2.24 + f/100 kHz*1.6 <sup>4)</sup>

C channel Accuracy	± (% of measured value + % of maximum peak value)						
	DC	0.05 Hz ... 45 Hz 65 Hz ... 200 Hz	45 Hz ... 65 Hz	200 Hz ... 500 Hz	500 Hz ... 1 kHz	1 kHz ... 2 kHz	2 kHz ... 10 kHz
Voltage U*	0.1+0.1	0.02+0.05	0.02+0.02	0.05+0.05	0.2+0.1	1.0+0.5	f/1 kHz*1.0 + f/1 kHz*1.0
Current I*	0.1+0.1 <sup>1)</sup>	0.02+0.05 <sup>3)</sup>	0.02+0.02 <sup>3)</sup>	0.05+0.05 <sup>3)</sup>	0.2+0.1 <sup>3)</sup>	1.0+0.5 <sup>3)</sup>	f/1 kHz*1.0 + f/1 kHz*1.0 <sup>3)</sup>
Current I <sub>SENSOR</sub>	0.1+0.1	0.02+0.05	0.02+0.02	0.05+0.05	0.2+0.1	1.0+0.5	f/1 kHz*1.0 + f/1 kHz*1.0
Power	0.16+0.1 <sup>2)</sup>	0.032+0.05 <sup>4)</sup>	0.03+0.01 <sup>4)</sup>	0.08+0.05 <sup>4)</sup>	0.32+0.1 <sup>4)</sup>	1.6+0.5 <sup>4)</sup>	f/1 kHz*1.6 + f/1 kHz*1.0 <sup>4)</sup>

Accuracies valid for:	1. Sinusoidal voltages and currents 2. Ambient temperature (23±3) °C 3. Warm-up time 1 h 4. The maximum peak value for power is the product of the maximum peak value for voltage and the maximum peak value for current.	5. 0 ≤ λ ≤ 1 (power factor) 6. Current and voltage 10% ... 110% of nominal value 7. Adjustment carried out at 23 °C 8. Calibration interval 12 months
Other values	All other values are calculated from current, voltage and power. Accuracy resp. error limits are derived according to context (e.g. S = I * U, ΔS / S = ΔI / I + ΔU / U).	

<sup>1) 2) 3) 4)</sup> only valid in range 10 ... 32 A:

<sup>1)</sup> additional uncertainty  $\pm \frac{80 \mu\text{A}}{\text{A}^2} * I_{\text{rms}^2}$    <sup>2)</sup> additional uncertainty  $\pm \frac{80 \mu\text{A}}{\text{A}^2} * I_{\text{rms}^2} * U_{\text{rms}}$    <sup>3)</sup> additional uncertainty  $\pm \frac{80 \mu\text{A}}{\text{A}^2} * I_{\text{rms}^2}$    <sup>4)</sup> additional uncertainty  $\pm \frac{80 \mu\text{A}}{\text{A}^2} * I_{\text{rms}^2} * U_{\text{rms}}$

<sup>e)</sup> Accuracy specification after non-persistent zero adjustment, temperature change after zero adjustment max. ±1 °C

# Measuring ranges for S - Channel

Voltage measuring ranges U*										
Nominal value AC / V	3	6	12.5	25	60	130	250	400	600	1000
Nominal value DC / V	5	10	20	45	90	180	360	720	1000	1500
Max. trms value / V	5,5	11	22	47	95	190	370	730	1010 <sup>x</sup>	1510 <sup>x</sup>
Max. peak value / V	6	12	25	50	100	200	400	800	1600	3200
Input impedance	2,69 MΩ 1%						approx. 4 pF			
Overload protection	UAC = 1000V + 10% continuously UAC = 1500V for 1 s UDC = 1500V + 10% continuously U = 2500V for 20 ms, transient									
Earth capacitance	approx. 90 pF									

<sup>x</sup> See specification of overload capability, max. measurable RMS values, max. Isolation voltage and the warnings at the beginning of this section

Current measuring ranges I*								
Nominal value AC / A	0,005	0,01	0,02	0,04	0,08	0,15	0,3	0,6
Nominal value DC / A	0,01	0,02	0,04	0,08	0,15	0,3	0,6	1,2
Max. trms value A	0,011	0,021	0,042	0,084	0,16	0,32	0,64	1,25
Max. peak value A	0,014	0,028	0,056	0,112	0,224	0,449	0,898	1,795
Input impedance	approx. 2,2 Ω + 200 nH			approx. 600 mΩ + 200 nH			approx. 80 mΩ + 200 nH	
Overload protection	LMG in operation, 10 A continuously, 150 A for 10 ms							
Earth capacitance	approx. 90 pF							

Current measuring ranges I*						
Nominal value AC / A	1,2	2,5	5	10	20	32
Nominal value DC / A	2,5	5	8	15	22	32
Max. trms value A	2,6	5,2	8,4	15,5	22,5	32,5 <sup>x</sup>
Max. peak value A	3,75	7,5	15	30	60	120
Input impedance	approx. 20 mΩ + 200 nH			approx. 10 mΩ + 200 nH		
Overload protection	LMG in operation, 32 A continuously, 150 A for 10 ms					
Earth capacitance	approx. 90 pF					

Sensor input U <sub>SENSOR</sub> , I <sub>SENSOR</sub>								
Nominal value AC / V	0,03	0,06	0,12	0,25	0,5	1	2	4
Nominal value DC / V	0,08	0,15	0,3	0,6	1,2	2,5	5	10
Max. trms value V	0,085	0,16	0,32	0,65	1,3	2,75	5,5	11
Max. peak value V	0,0977	0,1953	0,3906	0,7813	1,563	3,125	6,25	12,5
Input impedance	99,8 kΩ 1%					approx. 34 pF		
Overload protection	100 V continuously, 250 V for 1 s							
Earth capacitance	approx. 90 pF							

This channel is rated for measuring voltages from ☉ U\* to ☉ U up to:

- $U_{AC} = U_{DC} = 600V$ , measurement category CAT IV
- $U_{AC} = U_{DC} = 1000V$ , measurement category CAT III
- $U_{DC} = 1500V$ , measurement category CAT II

This channel is rated for insulation voltages from ☉ U\*, ☉ U, ☉ U<sub>SENSOR</sub>, ☉ I\*, ☉ I, ☉ I<sub>SENSOR</sub> to protective earth PE and from ☉ U to ☉ I up to:

- $U_{AC} = U_{DC} = 600V$ , measurement category CAT IV
- $U_{AC} = U_{DC} = 1000V$ , measurement category CAT III

# Measuring ranges for A / B / C - Channels

Voltage measuring ranges U*										
Nominal value (V)	3	6	12.5	25	60	130	250	400	600	1000
Max. trms value (V)	3.3	6.6	13.8	27.5	66	136	270	440	660	1000
Max. peak value (V)	6	12	25	50	100	200	400	800	1600	3200
Overload protection	1000V + 10% continuously, 1500V for 1s, 2500V for 20ms									
Input impedance	2.69 MΩ, 4 pF									
Earth capacitance	approx. 90 pF									

Current measuring ranges I*														
Nominal value (A)	0.005	0.01	0.02	0.04	0.08	0.15	0.3	0.6	1.2	2.5	5	10	20	32
Max. trms value (A)	0.0055	0.011	0.022	0.044	0.088	0.165	0.33	0.66	1.32	2.75	5.5	11	22	32
Max. peak value (A)	0.014	0.028	0.056	0.112	0.224	0.469	0.938	1.875	3.75	7.5	15	30	60	120
Input impedance	approx. 2.2 Ω		approx. 600 mΩ			approx. 80 mΩ			approx. 20 mΩ			approx. 10 mΩ		
Overload protection permanent (A)	LMG in operation 10A									LMG in operation 32A				
Overload protection short-time (A)	150A for 10ms													
Earth capacitance	approx. 90 pF													

Sensor inputs U <sub>SENSOR</sub> I <sub>SENSOR</sub>									
Nominal value (V)	0.03	0.06	0.12	0.25	0.5	1	2	4	
Max. trms value (V)	0.033	0.066	0.132	0.275	0.55	1.1	2.2	4.4	
Max. peak value (V)	0.0977	0.1953	0.3906	0.7813	1.563	3.125	6.25	12.5	
Overload protection	100V continuously, 250V for 1s								
Input impedance	100kΩ, 34 pF								
Earth capacitance	approx. 90 pF								

<b>Isolation</b>	All current and voltage inputs are isolated against each other, against remaining electronics and against earth. Max. 1000V / CAT III resp. 600V / CAT IV
<b>Synchronization</b>	Measurements are synchronized on the signal period. The period is determined based on „external“, u(t) or i(t), in combination with configurable filters. Therefore readings are very stable, especially with PWM controlled frequency converters and amplitude modulated electronic loads.
<b>Scope function</b>	Graphical display of sample values over time in two scopes with 8 signals each
<b>Plot function</b>	Two time (trend-) diagrams of max. 8 parameters each, max. resolution 10 ms
<b>External graphics interface (L671-OPT-DVI)</b>	DVI interface for external screen output
<b>Process signal interface (L6-OPT-PSI)</b>	2 fast analog inputs (150 kS/s, 16 bit, BNC) 8 analog inputs (100 S/s, 16 bit, D-Sub:DE-09) 32 analog outputs (output per cycle, 14 bit, D-Sub: DA-15 & DB-25) 8 switching outputs (6 switches with 2 connections each and 2 switching outputs with common negative, D-Sub: DB-25) 8 switching inputs (150 kS/s, in two groups 4 inputs each with common ground, D-Sub: DB-25) Speed-/torque-/frequency inputs (150 kS/s, D-Sub: DA-15)
<b>Star-delta conversion (L6-OPT-SDC)</b>	Conversion of line voltages to phase voltages and computation of resulting active power
<b>Harmonics at device level (L6-OPT-HRM)</b>	Harmonics and interharmonics up to 2,000th order, independent and simultaneously for each group
<b>CE Harmonics (L6-OPT-HRM)</b>	According to IEC EN 61000-4-7
<b>Flicker (L6-OPT-FLK)</b>	According to IEC EN 61000-4-15
<b>LMG Remote</b>	LMG600 expansion software, basic module for remote configuration and operation via PC
<b>LMG Test Suite</b>	LMG600 software for conformity tests according to: IEC EN 61000-3-2 & 61000-3-12 for harmonics (LMG-TEST-CE-HRM) IEC EN 61000-3-3 & 61000-3-11 for flicker (LMG-TEST-CE-FLK) IEC 62301 & EN 50564 for standby power (LMG-TEST-CE-STBY)
<b>Miscellaneous</b>	
Dimensions	LMG671: Table-top version: (WxHxD) 433 mm x 177 mm x 590 mm, 19" version: (WxHxD) 84 HP x 4 RU x 590 mm
Display	10.1", 1280 x 800 px
Weight	Depending on installed options: max. 18.5 kg for LMG671
Protection class	EN 61010 (IEC 61010, VDE 0411), protection class I / IP20 in accordance with EN 60529
Electromagnetic compatibility	EN 61326
Temperature	5 ... 40 °C (operation) / -20 ... 50 °C (storage)
Climatic category	Normal environmental conditions according to EN 61010
Line input	100 ... 230V, 47 ... 63 Hz, max. 400W for LMG671

# Accessories program (excerpt)

## Current sensors

Type	Ring-type transducers					Current clamps		Shunt
								
Name	PCT	Hallxxx-L6	DS	WCT	LMG-Z5XX	L60-Z406, L60-Z60/66	L60-Z68	LMG-SH (-P)
Signal type	AC+DC			AC		AC	AC+DC	AC+DC
Current ranges	200...2000 A <sub>rms</sub>	100...2000 A <sub>rms</sub>	50...7000 A <sub>rms</sub>	100...1000 A <sub>rms</sub>	750 A <sub>rms</sub> ...10 kA <sub>rms</sub>	40...3 kA <sub>rms</sub>	1 kA <sub>rms</sub>	22 mA <sub>rms</sub> ...1 A <sub>rms</sub>
Best accuracy	0.01%	0.5%	0.01%	0.25%	0.02%	0.2%	2.0%	0.15%
Max. bandwidth	DC...1 MHz	DC...100 kHz	DC...1 MHz	30 Hz...1 MHz	15 Hz...5 kHz	5 Hz...50 kHz	DC...2 kHz	DC...100 kHz
Power supply by LMG600	PCT200/600	Yes	No	Not required		Yes		Not required
Plug 'n' Measure	PCT200/600	Yes	No	No		Yes		No

## High-voltage dividers



Name	HST3	HST6	HST9	HST12
Signal type	AC+DC			
Max. voltage	4.2 kV <sub>eff</sub>	8.4 kV <sub>eff</sub>	12.6 kV <sub>eff</sub>	16.8 kV <sub>eff</sub>
Best accuracy	0.05%			
Max. bandwidth	0 Hz...300 kHz			
# of phases	1 to 3			
Plug 'n' Measure	No			

## Breakout boxes



Name	LMG-MAS	LMG-MAK1	BOB-CEE3-16	BOB-CEE3-32
Nominal voltage	250V	250V	230 / 400V	
Category	CAT II		CAT II	
Safety standard	IEC / EN61010-1		IEC / EN61010-1	
Socket for load connection	16 A 250V CEE 7/4	10 A 250V IEC 60320-C14	16 A 400V 3L+N+PE, 6 h IEC 60309	32 A 400V 3L+N+PE, 6 h IEC 60309

The Breakout Boxes enable access to the individual lines in a connector for measurement, and provide an easy and elegant way to take measurements on single and three-phase consumers.

## LMG Remote



The LMG Remote PC software allows to easily control the LMG600 remotely from a Windows PC. Since this software mimicks the measuring device itself down to the last detail, the LMG600 can be operated as usual, even from the PC - no rethinking required, no familiarization time.

## LMG Test Suite



The tests performed by LMG Test Suite are in accordance with the currently valid edition of EN 61000-3-2/-12, EN 61000-3/-11, IEC 62301 and EN 50564. Measurements according to ECE R-10.4 Annex 11 (electromagnetic compatibility of vehicles), for example, are also possible.