

Anritsu Advancing beyond

Network Master™ Series

Network Master Pro MT1000A

10G Multirate Module	MU100010A1
100G Multirate Module	MU100011A
High Performance GPS Disciplined Oscillator	MU100090A
High Performance GNSS Disciplined Oscillator	MU100090B

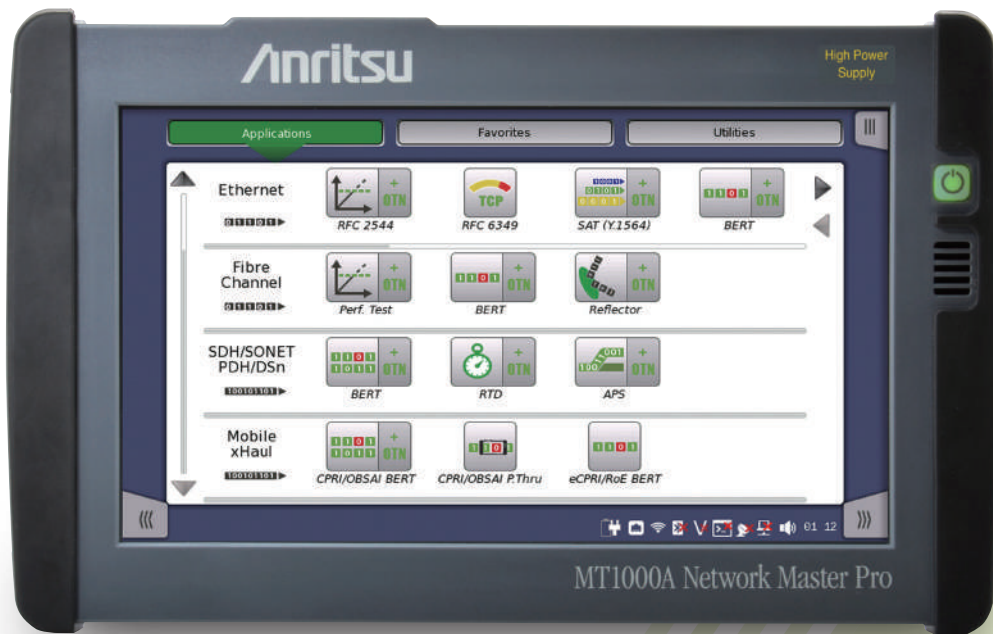

Network Master Pro MT1000A Overview

Redefining Transport Testing

Network standards for transport tests are becoming more diverse, such as Ethernet, OTN, SDH/SONET, eCPRI/RoE/CPRI/OBSAI, PTP, Fibre Channel, etc. Additionally, speeds are increasing with 100G/25G Ethernet and 16G Fibre Channel development, and networks are continuing to evolve. With an easily configured modular design to support changing network standards and an easy-to-use GUI, the Network Master Pro MT1000A is perfect for speedy I&M of wide-area networks.

Evolving Networks and Required Test Equipment

Core and metro networks are progressing to 100G interfaces. In addition, operators are also examining adoption of new and more types of client interfaces. Onsite network I&M work requires cost-effective support for diversifying services at speeds from 1G to 100G with a field tester that improves work efficiency.

- All-in-one transport tester
 - supports testing from 10 Mbps to 100 Gbps
- Easy and intuitive GUI
- WLAN*1/Bluetooth**2/LAN connectivity
- PDF, CSV and XML report generation for documenting test results
- Remote operation
- Remote control
- Compact, lightweight design for maximum field portability
- Modular platform ensuring maximum return on investment

*1: Available for certified countries and regions including USA, Canada, Japan and EU countries. Please visit the Anritsu web site for updated information.

**2: The Bluetooth® mark and logs are owned by Bluetooth SIG, Inc. and are used by Anritsu under license.

Connector Panel Overview

Front View

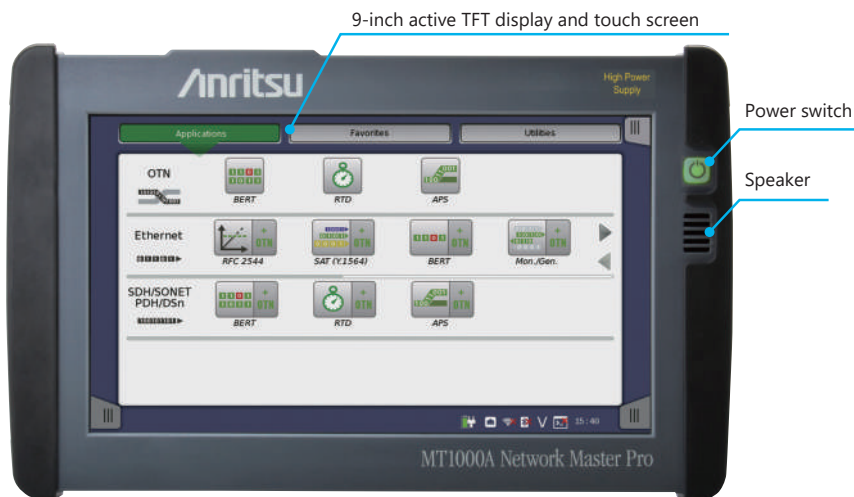

Just a fraction larger than 9-inch screen

Connector Panel Overview

Top View

10G Multirate Module MU100010A1

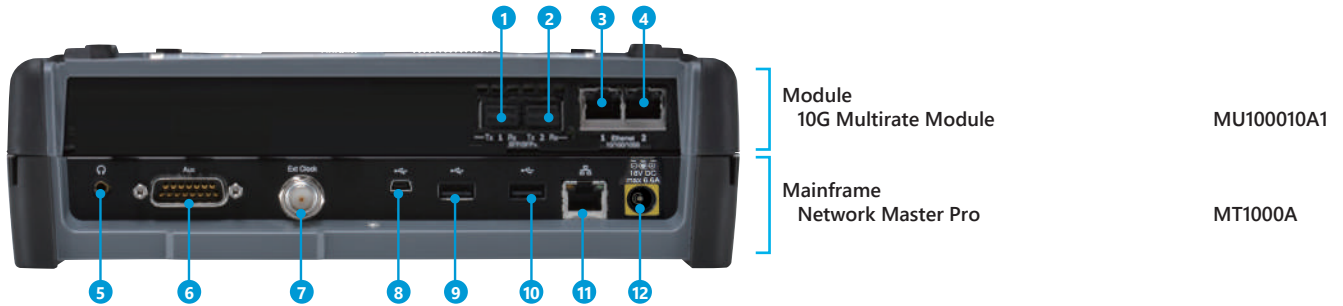

100G Multirate Module MU100011A

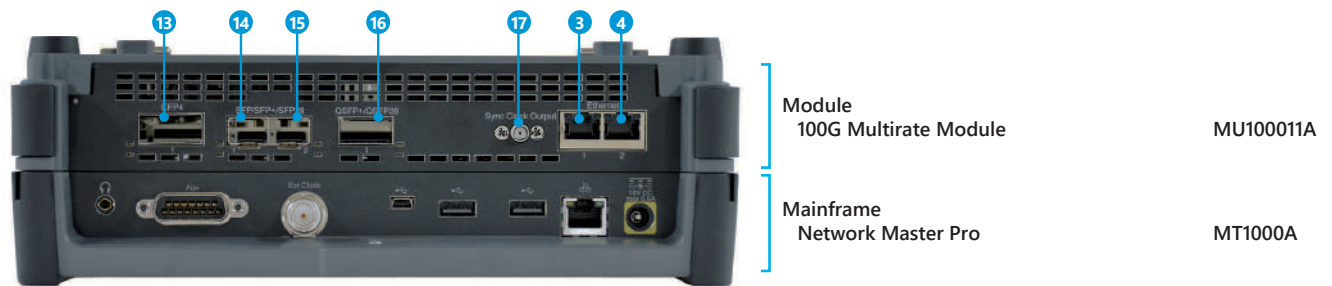

High Performance GNSS Disciplined Oscillator Configuration

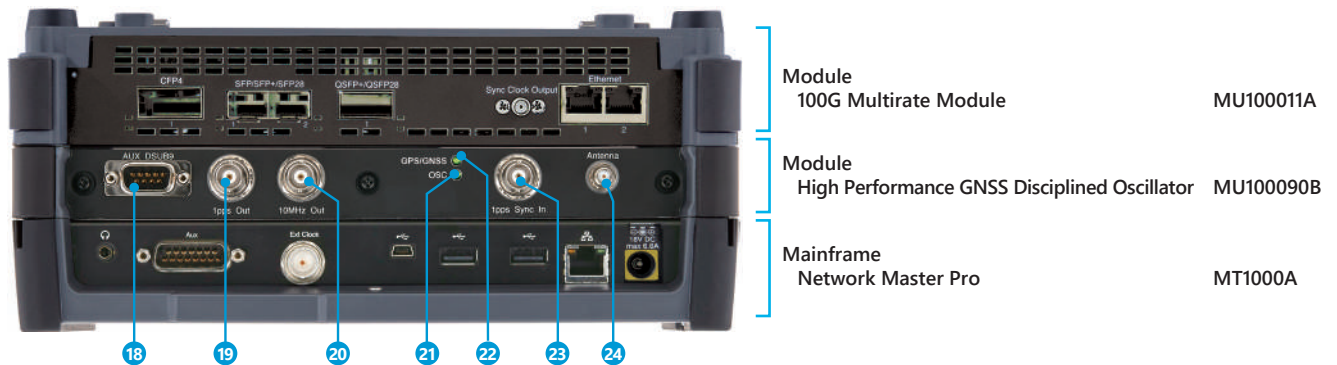

- 1 Port 1, Tx/Rx SFP/SFP+ (OTN, Ethernet, eCPRI/RoE/CPRI/OBSAI, Fibre Channel, SDH/SONET optical)
- 2 Port 2, Tx/Rx SFP/SFP+ (OTN, Ethernet, eCPRI/RoE/CPRI/OBSAI, Fibre Channel, SDH/SONET optical)
- 3 Port 1, Tx/Rx RJ45 (Ethernet, eCPRI/RoE electrical)
- 4 Port 2, Tx/Rx RJ45 (Ethernet, eCPRI/RoE electrical)
- 5 Audio (3.5ø: CTIA Standard)
- 6 AUX (D-SUB 15 pin)
- 7 Clock Input
- 8 USB Mini-B
- 9 USB A
- 10 USB A
- 11 Ethernet Service Interface
- 12 DC Input (18 Vdc)
- 13 Port1, Tx/Rx CFP4 (OTN, Ethernet, eCPRI/RoE)
- 14 Port1, Tx/Rx SFP/SFP+/SFP28 (OTN, Ethernet, eCPRI/RoE/CPRI/OBSAI, Fibre Channel, SDH/SONET)
- 15 Port2, Tx/Rx SFP/SFP+/SFP28 (OTN, Ethernet, eCPRI/RoE/CPRI/OBSAI, Fibre Channel, SDH/SONET)
- 16 Port1, Tx/Rx QSFP+/QSFP28 (OTN, Ethernet, eCPRI/RoE)
- 17 Port1, Sync. Clock Output
- 18 AUX (D-SUB 9 pin)
- 19 1 pps Output (REF)
- 20 10 MHz Output
- 21 OCS LED
- 22 GNSS received LED
- 23 1 pps Sync In
- 24 GNSS Antenna Input

Network Master Pro MT1000A Mainframe Specifications

User Interfaces	
Display	9-inch active TFT display (800 × 480 pixels) and touch screen
Supported Languages	English, Chinese, Japanese, French, Russian, Spanish, Finnish, Korean, German

Service Interfaces	
USB Data Interface	MT1000A operates as host: USB 2.0 type A (2 ports) MT1000A operates as device: USB 2.0 type Mini-B (1 port)
Ethernet Interface	Ethernet 10M/100M/1000M, Connector: RJ45
WLAN Interface*1	IEEE 802.11 b/g/n
Bluetooth® Interface	Bluetooth 2.1 +EDR

*1: Available for certified countries and regions including USA, Canada, Japan and EU countries. Please visit the Anritsu web site for updated information.

Other Interfaces	
Audio Interface	For connection of CTIA Standard head set Connector: 3.5-mm diameter jack
AUX Connector	For connecting optional G0325A GPS receiver With MT1000A-005, following two interfaces are available using J1705A 1PPS Ref In: TTL 50Ω/DC 1PPS Test In: TTL 50Ω/DC
Built-in Loudspeaker	Monitors speech of voice channel Output level: user-controlled from user interface
Internal Clock	Accuracy: ±4.6 ppm or less, STRATUM3 compliant
Ext. Clock Input	For connection of external clock signals: SETS (E1: 2.048 Mbps), BITS (DS1: 1.544 Mbps) or 2.048 MHz TTL signal in accordance with ITU-T G.703, 10 MHz TTL signal in accordance with ITU-T G.703 Connector: BNC (50Ω)

Miscellaneous		
Battery	10.8 V rechargeable and replaceable intelligent Li-ion battery Operating time: 1.5 hours (typ., in case of 100 GbE) Charging time: 6 hours (Max.) Remaining capacity indication: %	
Mains Adapter	Input: 100 V(ac) to 240 V(ac), 50 Hz/60 Hz Output: 18 V(dc), 3.62 A (max.) Power Consumption: ≤65 W With MT1000A-006*2 Input: 100 V(ac) to 240 V(ac), 50 Hz/60 Hz Output: 18 V(dc), 6.6 A (max.) Power Consumption: ≤120 W	
Dimensions and Mass	257 (W) × 164 (H) × 82 (D) mm (Exclude Projection, MT1000A + MU100010A1) 257 (W) × 164 (H) × 89 (D) mm (Exclude Projection, MT1000A + MU100011A) 2.7 kg (including MT1000A, MU100010A1 and battery) 2.7 kg (including MT1000A, MU100011A and battery)	
Environmental	Temperature Operating : 0°C to +50°C (non-condensing) Charging: 0°C to +40°C (non-condensing) Storage: -30°C to +60°C (non-condensing, without battery or AC adapter) -20°C to +50°C (non-condensing, with battery and AC adapter) Humidity Operating: ≤85% RH (non-condensing) Storage and Transportation: ≤90% RH (non-condensing, without battery and AC adapter) Storage and Transportation: ≤85% RH (non-condensing, with battery and AC adapter)	
CE	EMC	2014/30/EU, EN61326-1, EN61000-3-2
	LVD	2014/35/EU, EN61010-1
	RoHS	2011/65/EU, (EU) 2015/863, EN IEC 63000: 2018
UKCA	EMC	S.I. 2016 No.1091, EN 61326-1, EN61000-3-2
	LVD	S.I. 2016 No.1101, EN 61010-1
	RoHS	S.I. 2012 No.3032, EN IEC 63000: 2018

*2: MT1000A-006 is required for MU100011A.



Network Master Pro MT1000A with MT1000A-006
(A yellow border is printed around DC Input.)



Network Master Pro MT1000A

10G Multirate Module MU100010A1 Specifications

Test Interface						
Test Port	SFP/SFP+: 2 slots SFF-8431, SFF-8472 compliant, IEEE 802.3ae-2002, IEEE 802.3-2008 compliant RJ45: 2 sockets IEEE 802.3-2008 10BASE-T, 100BASE-TX, 1000BASE-T compliant Auto MDI-X 10 Mbps/100 Mbps full/half duplex, 1000 Mbps full duplex					
Bit Rate*1	Standard	Bit Rate	Interfaces	Standard	Bit Rate	Interfaces
	10BASE-T	12.5 Mbps	RJ45	CPRI Option1	614.4 Mbps	SFP
	100BASE-TX	125 Mbps	RJ45	CPRI Option2	1228.8 Mbps	SFP
	1000BASE-T	1.25 Gbps	RJ45	CPRI Option3	2457.6 Mbps	SFP, SFP+
	100BASE-XX	125 Mbps	SFP	CPRI Option4	3072.0 Mbps	SFP, SFP+
	1000BASE-XX	1.25 Gbps	SFP	CPRI Option5	4915.2 Mbps	SFP+
	10GBASE-XX	10.3125 Gbps	SFP+	CPRI Option6	6144.0 Mbps	SFP+
	STM-1/OC-3	155.52 Mbps	SFP	CPRI Option7	9830.4 Mbps	SFP+
	STM-4/OC-12	622.08 Mbps	SFP	CPRI Option8	10137.6 Mbps	SFP+
	STM-16/OC-48	2.48832 Mbps	SFP	OBSAI 1x	768 Mbps	SFP
	STM-64/OC-192	9.95328 Mbps	SFP+	OBSAI 2x	1536 Mbps	SFP, SFP+
	OTU1	2.666057143 Gbps	SFP	OBSAI 4x	3072 Mbps	SFP, SFP+
	OTU2	10.70922532 Gbps	SFP+	OBSAI 8x	6144 Mbps	SFP+
	OTU1e	11.04910714 Gbps	SFP+			
	OTU2e	11.09572785 Gbps	SFP+			
	OTU1f	11.27008929 Gbps	SFP+			
	OTU2f	11.31764241 Gbps	SFP+			
	1GFC	1.0625 Gbps	SFP			
	2GFC	2.125 Gbps	SFP			
	4GFC	4.25 Gbps	SFP			
	8GFC	8.5 Gbps	SFP+			
	10GFC	10.51875 Gbps	SFP+			

Miscellaneous		
Dimensions and Mass	257 (W) × 163 (H) × 38.5 (D) mm, ≤1.1 kg	
Environmental	Temperature and Humidity Operating: 0°C to +50°C, ≤80% RH (non-condensing) Storage: -30°C to +60°C, ≤80% RH (non-condensing)	
CE	EMC	2014/30/EU, EN61326-1, EN61000-3-2
	LVD	2014/35/EU, EN61010-1
	RoHS	2011/65/EU, (EU) 2015/863, EN IEC 63000:2018
UKCA	EMC	S.I. 2016 No.1091, EN 61326-1, EN61000-3-2
	LVD	S.I. 2016 No.1101, EN 61010-1
	RoHS	S.I. 2012 No.3032, EN IEC 63000:2018
Laser Safety*3	IEC 60825-1: 2014 CLASS 1 21CFR1040.10 and 1040.11*2	

*1: The frequency accuracy depends on the accuracy of the MT1000A internal clock or the external clock of MT1000A.

Refer to the external interfaces in MT1000A specifications.

*2: Excludes deviations caused by conformance to Laser Notice No. 56 dated MAY 8, 2019

*3: Safety measures for laser products

This product complies with optical safety standards in 21CFR1040.10, 1040.11 and IEC 60825-1; the following descriptive labels are affixed to the product.



THIS PRODUCT COMPLIES WITH 21 CFR 1040.10 AND 1040.11 EXCEPT FOR
 DEVIATIONS PURSUANT TO LASER NOTICE NO. 56 DATED MAY 8, 2019



10G Multirate Module MU100010A1

100G Multirate Module MU100011A*1

Test Interface							
Test Port		RJ45: 2 sockets IEEE 802.3-2008 10BASE-T, 100BASE-TX, 1000BASE-T compliant Auto MDI-X 10 Mbps/100 Mbps Full/Half duplex, 1000 Mbps Full duplex SFP/SFP+/QSFP28: 2 slots SFF-8402, SFF-8431, SFF-8472 compliant, IEEE 802.3ae-2002, IEEE 802.3-2008, IEEE 802.3by compliant QSFP+/QSFP28: 1 port SFF-8436, SFF-8636, SFF-8665 compliant, IEEE 802.3ba-2010 compliant CFP4: 1 port CFP MSA CFP4 Hardware Specification, Rev. 1.1 compliant CFP MSA Management Interface Specification V2.2 R06a compliant(However, MSA 100GLH is not support) IEEE 802.3ba-2010 compliant					
Bit Rate*2		Standard		Bit Rate		Interfaces	
		10BASE-T		12.5 Mbps		RJ45	
		100BASE-TX		125.0 Mbps		RJ45	
		1000BASE-T		1.25 Gbps		RJ45	
		100BASE-XX		125.0 Mbps		SFP	
		1000BASE-XX		1.25 Gbps		SFP	
		10GBASE-XX		10.31250 Gbps		SFP+	
		25GBASE-XX		25.78125 Gbps		SFP28	
		40GBASE-XX4		10.31250 Gbps × 4 Lane		QSFP+	
		100GBASE-XX4		25.78125 Gbps × 4 Lane		CFP4, QSFP28	
		STM-1/OC-3		155.52 Mbps		SFP	
		STM-4/OC-12		622.08 Mbps		SFP	
		STM-4/OC-12		622.08 Mbps		SFP	
		STM-16/OC-48		2.48832 Gbps		SFP	
		STM-64/OC-192		9.95328 Gbps		SFP+	
		OTU1		2.666057143 Gbps		SFP	
		OTU2		10.70922532 Gbps		SFP+	
		OTU1e		11.04910714 Gbps		SFP+	
		OTU2e		11.09572785 Gbps		SFP+	
		OTU1f		11.27008929 Gbps		SFP+	
		OTU2f		11.31764241 Gbps		SFP+	
		OTU3		10.75460339 Gbps × 4 Lane		QSFP+	
		OTU3e1		11.14274364 Gbps × 4 Lane		QSFP+	
		OTU3e2		11.14583889 Gbps × 4 Lane		QSFP+	
		OTU4		27.95249339 Gbps × 4 Lane		CFP4, QSFP28	
		1GFC		1.0625 Gbps		SFP	
		2GFC		2.125 Gbps		SFP, SFP+	
		4GFC		4.25 Gbps		SFP, SFP+	
		8GFC		8.5 Gbps		SFP+	
		10GFC		10.51875 Gbps		SFP+	
		16GFC		14.025 Gbps		SFP+	
		CPRI Option1		614.4 Mbps		SFP	
		CPRI Option2		1228.8 Mbps		SFP	
		CPRI Option3		2457.6 Mbps		SFP, SFP+	
		CPRI Option4		3072.0 Mbps		SFP, SFP+	
		CPRI Option5		4915.2 Mbps		SFP+	
		CPRI Option6		6144.0 Mbps		SFP+	
		CPRI Option7		9830.4 Mbps		SFP+	
		CPRI Option8		10137.6 Mbps		SFP+	
		CPRI Option9		12165.12 Mbps		SFP+	
		CPRI Option10		24330.24 Mbps		SFP28	
		OBSAI 1x		768 Mbps		SFP	
		OBSAI 2x		1536 Mbps		SFP, SFP+	
		OBSAI 4x		3,072 Mbps		SFP, SFP+	
		OBSAI 8x		6,144 Mbps		SFP+	
Sync Clock Output		Frequency Select 1/8 or 1/16 against the bit rate of the data lane. 100 GigE: CAUI4 25 GigE: 25GAUI OTU4: OTL 4.4 Level: 250 mVp-p (min.), 550 mVp-p (max.) Termination: 50Ω/AC (Single ended) Connector: SMA					

Miscellaneous		
Dimensions and Mass		257 (W) × 163 (H) × 48 (D) mm, ≤1.1 kg
Environmental		Temperature and Humidity Operating: 0°C to +45°C, ≤85% RH (non-condensing) Storage: -30°C to +60°C, ≤90% RH (non-condensing)
CE	EMC	2014/30/EU, EN61326-1, EN61000-3-2
	LVD	2014/35/EU, EN61010-1
	RoHS	2011/65/EU, (EU) 2015/863, EN IEC 63000:2018
UKCA	EMC	S.I. 2016 No.1091, EN 61326-1, EN61000-3-2
	LVD	S.I. 2016 No.1101, EN 61010-1
	RoHS	S.I. 2012 No.3032, EN IEC 63000:2018
Laser Safety*3		IEC 60825-1: 2014 CLASS 1 21CFR1040.10 and 1040.11*4

*1: MT1000A-006 is required for MU100011A.

*2: The frequency accuracy depends on the accuracy of the MT1000A internal clock or the external clock of MT1000A. Refer to the external interfaces in MT1000A specifications.

*3: Safety measures for laser products

This product complies with optical safety standards in 21CFR1040.10, 1040.11 and IEC 60825-1; the following descriptive labels are affixed to the product.

*4: Excludes deviations caused by conformance to Laser Notice No. 56 dated MAY 8, 2019

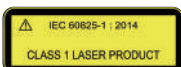

100G Multirate Module MU100011A

Sync Module MU100090A/MU100090B Specifications

Test Interface			
Model	MU100090A		MU100090B
Internal Oscillator	Rubidium atomic clock Aging: 2.5×10^{-11} /day 1×10^{-10} /month 1×10^{-9} /year		
Input/Output Interface	10 MHz External Clock Output	Connector: BNC Jack/50Ω (nom.) Level: TTL	
	1PPS Reference Output	Connector: BNC Jack/50Ω (nom.) Level: TTL	Connector: BNC Jack/50Ω (nom.) Level: TTL Polarity: Positive/Negative
	1PPS Sync Input	Usage: Synchronize the internal oscillator with this 1PPS, ITU-T G.703 Connector: BNC Jack/50Ω (nom.) Level: TTL Input Frequency Range: ± 10 ppb	
	Antenna Input	Connector: SMA Jack/50Ω (nom.) Feeding Antenna: +3.5 V/5 V Selectable, 50 mA max.	Connector: SMA Jack/50Ω (nom.) Feeding Antenna: Off/+3.5 V/5 V Selectable, 50 mA max.
	AUX Output	Usage: Provide MT1000A with ToD (NMEA0183) with J1705 (AUX interface adaptor) Connector: D-SUB 9 pin	
GNSS Signal Receive Specification	Supported Signal	GPS L1C/A	<ul style="list-style-type: none"> • GPS L1C/A, L2C • QZSS L1C/A, L2C • Beidou B1I, B2I • GLONASS L1OF, L2OF • Galileo E1B/C, E5B <p>* GPS L2C, QZSS L2C, GLONASS L2OF, Galileo E5B, Beidou B2I are available after MU100090B-001 is installed.</p> <p>* QZSS, GLONASS, Galileo, Beidou are available after MU100090B-002 is installed.</p>
	Number of Receivable Channel	50 channel	
Time Accuracy to GNSS Time	± 45 ns rms* ¹	Without MU100090B-001: ± 45 ns rms* ¹ With MU100090B-001: ± 10 ns rms* ²	
Holdover	300 ns/10,000 second * When OSC LED lit continuously for 3 hours or more and either GPS or external 1PPS signal synchronized for at least 30 minutes at constant ambient temperature while moving to Holdover	Without MU100090B-001: 300 ns/10,000 second With MU100090B-001: 70 ns/3,600 second 190 ns/10,000 second * When OSC LED lit continuously for 3 hours or more and either GNSS or external 1PPS signal Synchronized for at least 30 minutes at ambient temperature change within $\pm 3^\circ\text{C}$ while moving to Holdover	

Test Interface			
Model	MU100090A		MU100090B
Dimensions and Mass	257 (W) × 163 (H) × 25 (D) mm ≤0.8 kg		
Environmental	Temperature and Humidity Operating: 0°C to +50°C, ≤85% RH (non-condensing) Storage: -30°C to +60°C, ≤90% RH (non-condensing)		
CE	EMC	2014/30/EU, EN61326-1, EN61000-3-2	
	LVD	2014/35/EU, EN61010-1	
	RoHS	2011/65/EU, (EU) 2015/863, EN IEC 63000: 2018	
UKCA	EMC	S.I. 2016 No.1091, EN 61326-1, EN61000-3-2	
	LVD	S.I. 2016 No.1101, EN 61010-1	
	RoHS	S.I. 2012 No.3032, EN IEC 63000:2018	

*1: When OSC LED lit continuously for 3 hours or more and using Anritsu antenna under open skies with GNSS signal synchronized for at least 30 minutes at constant ambient temperature

*2: After OS LED lit and using Anritsu antenna under open skies with GNSS signal synchronized for at least 30 minutes at constant ambient temperature with multi-band setting and antenna position specified

⚠ CAUTION

Do not subject the equipment to mechanical vibration or shock and keep the equipment away from all magnets and magnetic objects. Otherwise, the built-in rubidium oscillator may be damaged or the performance degraded.

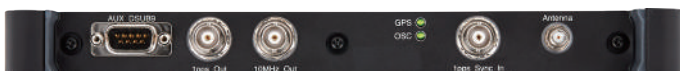

High Performance GPS Disciplined Oscillator MU100090A

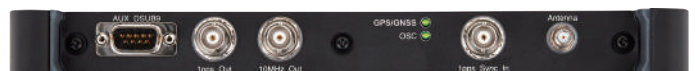

High Performance GNSS Disciplined Oscillator MU100090B

Ethernet Testing Specifications

Common		
Model No.	MU100010A1	MU100011A
Bit Rate	10 Mbps (RJ45), 100 Mbps (RJ45/SFP), 1 Gbps (RJ45/SFP), 10 Gbps (SFP+)	10 Mbps (RJ45), 100 Mbps (RJ45/SFP), 1 Gbps (RJ45/SFP), 10 Gbps (SFP+), 25 Gbps (SFP28), 40 Gbps (QSFP+), 100 Gbps (CFP4/QSFP28)
Test Configuration	RFC 2544, RFC 6349, Y.1564, BERT, Monitor/Generator, Pass-through, Reflector, Channel Stat., Ping, Traceroute, Cable Test, Sync Test	
Auto MDI-X	On/Off	
Encapsulation	Ether Type II (DIX v.2), IEEE 802.3 with 802.2 (LLC1), IEEE 802.3 with SNAP	
100 GbE, 25 GbE FEC	—	FEC enable : On/Off FEC Code : RS (528, 514, 7, 10), RS (544, 514) FEC status & counter Loss of FEC alignment, Corrected CW, Uncorrectable CW, Corrected Symbol each lane FEC related Error Injection Bit error per CAUI4 lane or 25G CAUI encoded RS-FEC (Injection timing is Single/Burst.)

Configuration, Monitor/Generate		
Model No.	MU100010A1	MU100011A
Traffic Generation	<ul style="list-style-type: none"> Transmitting mode: Normal, Burst Variable line rate traffic generation, up to full line rate Line load profile: Constant, Ramp Traffic duration: Continuous, Programmable number of seconds or frames Adjustable frame size: 44 bytes to 16000 bytes Frame sizes: Constant, Stepped, Random Payload profiles: Data, Video, Voice User-defined traffic mix of unicast and broadcast frames Fixed or incremented IP identifier User programmable DSCP/TOS byte Configurable IP and Ethernet source and destination addresses (supports IPv4 and IPv6 addressing) <ul style="list-style-type: none"> IPv4: Fixed, DHCP, DNS IPv6: Fixed, NDP Address increment, Decrement and Random generation supported User programmable UDP/TCP address Automatic TCP connect (user selectable) UDP check sum: Automatic, Fixed (null); TCP check sum: Automatic Generate pause frames, Respond to pause frames Answer incoming ARP, Ping requests (On/Off) IGMP: Join/Leave (Support version: IGMPv1, IGMPv2, IGMPv3) MLD: Join/Leave (Support version: MLDv1, MLDv2) 	<ul style="list-style-type: none"> Transmitting mode: Normal, Burst Variable line rate traffic generation, up to full line rate Line load profile: Constant, Ramp Traffic duration: Continuous, Programmable number of seconds or frames Adjustable frame size: 60 bytes to 16000 bytes Frame sizes: Constant, Stepped, Random Payload profiles: Data, Video, Voice User-defined traffic mix of unicast and broadcast frames Fixed or incremented IP identifier User programmable DSCP/TOS byte Configurable IP and Ethernet source and destination addresses (supports IPv4 and IPv6 addressing) <ul style="list-style-type: none"> IPv4: Fixed, DHCP, DNS IPv6: Fixed, NDP Address increment, Decrement and Random generation supported User programmable UDP/TCP address Automatic TCP connect (user selectable) UDP check sum: Automatic, Fixed (null); TCP check sum: Automatic Generate pause frames, Respond to pause frames Answer incoming ARP, Ping requests (On/Off) IGMP: Join/Leave (Support version: IGMPv1, IGMPv2, IGMPv3) MLD: Join/Leave (Support version: MLDv1, MLDv2) Link Fault Signaling (LFS) Emulation (10 Gbps, 25 Gbps, 40 Gbps, 100 Gbps)
Stacked VLAN	Up to 8 user-settable VLAN tags Parameters per VLAN tag: <ul style="list-style-type: none"> Ether-type 0x8100 (802.1Q), 0x88a8 (802.1ad), 0x9100 or 0x9200 User-defined VLAN ID, CFI, VLAN priority Address increment, Decrement and Random generation supported Only one VLAN level supported at traceroute and RFC 2544 router latency tests. Only two VLAN level supported at ping.	
Multistream	Number of streams: Up to 16 streams per port can be activated	
Latency Resolution	5 ns	
Transmit Signal Clock Sources	Internal, Received clock, 2-MHz signal, SETS (E1: 2.048 Mbps), BITS (DS1: 1.544 Mbps), PTP (IEEE 1588 v2) recovered clock or signal from optional GPS receiver Frequency deviation: ±100 ppm (1-ppm steps)	Internal, Received clock, 2-MHz signal, SETS (E1: 2.048 Mbps), BITS (DS1: 1.544 Mbps), PTP (IEEE 1588 v2) recovered clock or signal from optional GPS receiver Frequency deviation: ±200 ppm (0.1-ppm steps)
Receive Setting	<ul style="list-style-type: none"> User-defined expected preamble length: 3 bytes to 15 bytes User-defined IFG lower threshold: 8 bytes to 15 bytes (RJ45 port only) User-defined Jumbo frame size upper limit: 1519 bytes to 16000 bytes 	
Error Generation	<ul style="list-style-type: none"> LAN IFG for Ethernet (RJ45 port only), FCS, Preamble, Error symbol/block, Wrong IP check sum, Fragmented IP, Wrong layer 4 check sum, PRBS bit error, BER test sequence error PCS (10 Gbps) Invalid block type (0x00, 0x2d, 0x33, 0x66), Invalid sync header (00, 11), Invalid alignment marker, BIP error 	<ul style="list-style-type: none"> LAN IFG for Ethernet (RJ45 port only), FCS, Preamble, Error symbol/block, Wrong IP check sum, Fragmented IP, Wrong layer 4 check sum, PRBS bit error, BER test sequence error PCS (10 Gbps, 40 Gbps, 100 Gbps) Invalid block type (0x00, 0x2d, 0x33, 0x66), Invalid sync header (00, 11), Invalid alignment marker, BIP error

Ethernet Testing Specifications

Alarm Generation	No link, Remote fault, Local fault (10 Gbps) PCS (10 Gbps): High BER	No link, Remote fault, Local fault (10 Gbps, 40 Gbps, 100 Gbps) PCS (10 Gbps, 40 Gbps, 100 Gbps) : High BER
PCS Skew	—	40 Gbps, 100 Gbps • Insertion 100 Gbps Tx lane: 0 to 4224 bits 40 Gbps physical lane: 0 to 8448 bits • Detection Relative skew, Marker map

Result, Monitor/Generate		
Model No.	MU100010A1	MU100011A
Status	<ul style="list-style-type: none"> Link status, Interface type, Jabber detected, Frames present, MPLS/EoMPLS/VLAN, Speed, Full or half duplex, Local clock (Electrical 1000 Mbps), LFS LF/RF (10 Gbps), Signal present, Bit rate of incoming Ethernet signal, Auto negotiation complete Link partner abilities: <ul style="list-style-type: none"> Pause capable and Asymmetric pause request (not Ethernet 10 Gbps and more), Remote fault, Speed/Duplex Indicators for Utilization, Throughput and Errored frames Signal level indication for optical Ethernet interfaces LFS local fault, LFS remote fault, High BER, LOA (10 Gbps) Invalid sync header, Invalid alignment marker, BIP error, Invalid block (10 Gbps) 	<ul style="list-style-type: none"> Link status, Interface type, Jabber detected, Frames present, MPLS/EoMPLS/VLAN, Speed, Full or half duplex, Local clock (Electrical 1000 Mbps), LFS LF/RF (10 Gbps), Signal present, Bit rate of incoming Ethernet signal, Auto negotiation complete Link partner abilities: <ul style="list-style-type: none"> Pause capable and Asymmetric pause request (not Ethernet 10 Gbps and more), Remote fault, Speed/Duplex Indicators for Utilization, Throughput and Errored frames Signal level indication for optical Ethernet interfaces LFS local fault, LFS remote fault, High BER, LOA (10 Gbps, 25 Gbps, 40 Gbps, 100 Gbps) Invalid sync header, Invalid alignment marker, BIP error, Invalid block (10 Gbps, 25 Gbps, 40 Gbps, 100 Gbps)
Resolution	User-defined resolution for statistical measurements: 1, 2, 5, 10, 15, 30 s, 1, 5, 10, 15, 30 min, 1, 2, 4, 6, 12 h Event log: Major measurement events incl. errors and alarms are logged with 1-second resolution.	
Performance Statistics	• Utilization (Max./Min./Avg.), Throughput (Max./Min./Avg.), Frame rate (Max./Min./Avg.)	
Frame Statistics	<ul style="list-style-type: none"> Total frames, Total valid frames, Unicast/Multicast/Broadcast frames, Number of pause frames Number of VLAN tagged frames, Max. number of VLAN layers detected, Last received VLAN ID, Last received VLAN priority Number of MPLS frames and MPLS-TP frames. Max. number of MPLS layers detected. Last received MPLS Label, MPLS Priority and MPLS TTL. Number of PBB frames. Last received B/I-tag ID and B/I-tag priority. Total errored frames, Fragmented frames, Number of oversized and undersized (runts) frames, Number of FCS errored frames, Error symbol frames (not 10 Gbps)/Code violation frames (10 Gbps), Number of collisions (10 Mbps, 100 Mbps half duplex), Preamble violations, IFG violations (RJ45 port only), False carrier, LFS LF (local fault), LFS RF (remote fault) 	
Burst Statistics	Total frames, Total valid frames, Number of burst, Total frames in bursts, Burst size (Max./Min./Avg.)	
Frame Distribution Statistics	<ul style="list-style-type: none"> Total valid/ frames, 64 to 127, 128 to 255, 256 to 511, 512 to 1023, 1024 to 1518 byte frames, Total number of jumbo frames Frame size (Max./Min./Avg.) 	
Multistream Statistics	Available information per stream: <ul style="list-style-type: none"> Frame loss count/rate, Throughput, Latency, Packet jitter, Frames and bytes received and transmitted 	
Transmit Statistics	Total frames, Total valid frames, Unicast/Multicast/Broadcast frames, FCS errors, Total errors 64 to 127, 128 to 255, 256 to 511, 512 to 1023, 1024 to 1518 byte frames, Total number of jumbo frames Total number of frames (Tx (own port) – Rx (selectable port))	
Filter	Up to 8 filter conditions can be defined. Each condition can be applied as filter: IP or MAC source address, IP or MAC destination address, Broadcast address, IEEE OUI value, Encapsulation type, VLAN ID and VLAN tag priority, MPLS, PBB source and destination MAC address, PBB B/I-tag, MPLS-TP source and destination MAC address, TPC/UDP source and destination port, User-defined pattern at defined offset	
PCS Statistics	—	LOBL, Invalid sync header, Invalid Block, High BER, LFS Local Fault, LFS Remote Fault, LOA, Invalid alignment marker, BIP error, LOAML, Marker Map, Relative skew
Adjustable Threshold	Utilization, Throughput, Errored frames, Collision rate, Unicast frames, Multicast frames, Broadcast frames, Pause frames, Fragmented frames, Undersized frames (runts), Oversized frames, FCS errored frames, IFG violations (RJ45 port only), Preamble violations, BER test pattern errors, Sequence errors, Diff.Tx-Rx	
DHCP	<ul style="list-style-type: none"> Display source IPv4 address assigned by DHCP Display current lease expire time Display IPv4 addresses of primary and secondary DNS server when obtained by DHCP 	
NDP	• Apply and show source IPv6 address assigned by NDP	

Ethernet Testing Specifications

BER Test and Service Disruption Measurement	
BER Test	<p>Generation and detection of test patterns, Count of errors in received test pattern, Pattern generation: Unframed (Layer 1), Framed Ethernet (MAC) header (Layer 2), Framed Ethernet (MAC) header with IP header (Layer 3) or Framed Ethernet (MAC) header, Framed with IP header and TCP/UDP header (Layer 4), User-defined header pattern (14 byte to 256 byte), Detection of sequence errors, loss of sequence synchronization, Frame loss count and frame loss seconds</p> <p>Throughput measurement results are calculated for:</p> <ul style="list-style-type: none"> • Utilization layer, Physical layer, Physical layer excluding preamble, Link layer, Network layer and Data layer • Min./Max./Avg. values <p>Performance (M.2100 type) parameters: ES, SES, ALS, UAT, AVT, EFS Test patterns: PRBS 9, PRBS 11, PRBS 15, PRBS 20, PRBS 23, PRBS 29, PRBS 31, HF test pattern, CRPAT, JTPAT, SPAT, 55 Hex, Fox, 32-bit user programmable User-defined resolution: 1, 2, 5, 10, 15, 30 s, 1, 5, 10, 15, 30 min, 1, 2, 4, 6, 12 h Event log: Major measurement events incl. errors and alarms are logged with 1-second resolution.</p>
Error Generation	FCS, Preamble, Error symbol, IFG for Ethernet (RJ45 port only), Wrong IP check sum, Fragmented IP, Wrong layer 4 check sum, PRBS bit error, BER test sequence error
Alarm Generation	No link, Remote fault
Service Disruption Measurement	<p>Service disruption measurement activated as part of BER test</p> <ul style="list-style-type: none"> • Max./Avg. service disruption time, Resolution: 0.1 μs • Number of service disruptions • Disruption Type: Packet, LOS

RFC 2544 Testing	
Test modes	<p>Switch/Router test and Single ended network test modes:</p> <ul style="list-style-type: none"> • Throughput, Frame loss, Latency or Packet jitter, Back-to-back frames (burstability) <p>End-to-end network test mode (two MU100010A/MU100011A units in Local-remote setup):</p> <ul style="list-style-type: none"> • Throughput, Frame loss, Back-to-back frames (burstability) <p>Router latency test mode: IP ping based latency test or packet jitter</p>

Service Activation Test (Y.1564)	
Functions	<ul style="list-style-type: none"> • Up to 8 services per port • Color-aware and non-color-aware in combinations (IP DSCP or VLAN PCP) • Test modes: One-way (uni- or bi-directional, symmetrical or asymmetrical), Round-trip • Verification against service acceptance criteria: Information rate, Frame transfer delay, Frame delay variation, Frame loss rate, Availability <p>Optional GPS timing synchronization</p>
Service Configuration Test	<ul style="list-style-type: none"> • Subtests for: Committed information rate, Excess information rate, Traffic policing, Committed burst size, Excess burst size • Step duration: 1 s to 60 s (user programmable) • Number of steps: 1 to 10 (user programmable) • Slope: Rising/Falling • Results: Pass/Fail indication, IR (Min./Avg./Max.), FL (Count/FLR), FTD, FDV (Min./Avg./Max./Current (during measurement))
Service Performance Test	<ul style="list-style-type: none"> • All services tested simultaneously at CIR • Duration 15 min, 2 h, 24 h, user programmable • Results: Pass/Fail indication, IR (Min./Avg./Max.), FL (Count/FLR), FTD, FDV (Min./Avg./Max./Current (during measurement)), AVAIL (%), Unavail (s)

RFC 6349 TCP Throughput Test	
Supported Bit Rate	10 Mbps, 100 Mbps, 1 Gbps, 10 Gbps
Function	<p>Test Direction Setup</p> <ul style="list-style-type: none"> • Local \rightarrow Remote • Remote \rightarrow Local • Simultaneous in both directions <p>For RFC 6349 test sequence, user can choose to measure for:</p> <ul style="list-style-type: none"> • Path MTU • Baseline RTT • Window Scan and Throughput • Multi-Service <p>Multi-Service: DSCP or TOS can be set to each TCP connections</p> <p>Measurement results include:</p> <ul style="list-style-type: none"> • Auto-calculation of Bandwidth Delay Product (BDP) • Transmitted and Retransmitted Bytes • TCP Transfer Time Ratio • TCP Efficiency • Retransmitted Percentage • Buffer Delay Percentage <p>Supports connecting to iPerf server</p>

Ethernet Testing Specifications

Ethernet Network Synchronization Test	
SyncE Protocol Emulation	<ul style="list-style-type: none"> Support Interface: 10 Mbps (Electric/Optical), 100 Mbps (Electric/Optical), 1 Gbps (Electric/Optical), 10 Gbps (Optical), 25 Gbps (Optical) Signal generation for Quality Level (QL) specified by SyncE function Analysis of QL indicated in received Ethernet signal with alarm at missing QL indications. SyncE results: SSM Rx count and rate, SSM Tx count, Indicated QL statistics, SSF seconds ESMC messages captured and exported in Wireshark format.
SyncE Wander Measurement (MU100011A-021 and MT1000A-005 are required)	<ul style="list-style-type: none"> Supported Interface: GigE, 10 GigE, 25 GigE (optical interface) Reference: 10 MHz (One from MU100090B is recommended) Measurement Items: TIE, MTIE, TDEV TIE Sampling Rate: 30 sample/s Limit mask: G.8261, G.8262, G.8262.1
IEEE 1588 v2 Protocol Emulation	<ul style="list-style-type: none"> Support Interface: 10 Mbps (Electric/Optical), 100 Mbps (Electric/Optical), 1 Gbps (Electric/Optical), 10 Gbps (Optical), 25 Gbps (Optical) Each port of the Ethernet interface can act as a timing master or a timing slave independently. Supported profiles: G.8265.1, G.8275.1, G.8275.2, SMPTE 2059-2, User Defined When acting as master in Unicast (G.8265.1) mode, one slave is accepted at a time. Setting the profile to SMPTE 2059-2 sets IGMP/MLD join/leave. If the slave requires 32, 64, or 128 Sync messages per second, IEEE 1588-2008 paragraph 7.7.2.1 specifying 90% confidence interval is not supported. Configurable parameters <ul style="list-style-type: none"> Domain: 0 to 255 Step Mode: One-step, Two-step Delay Mechanism: Delay request/response, Peer delay Negotiation: On/Off (Unicast only) Clock Source: Internal or UTC locked with GPS Clock Identify Priority#1, #2, Class, Time Source, Accuracy Index: 0 to 255 Announce Interval: 1/8 to 32 s Announce Timeout: 2 to 255 s Sync Interval: 1/128 to 32 s Minimum Delay Request Interval: 1/128 to 32 s Unicast Duration: 60 s to 1,000 s Protocol Stack <ul style="list-style-type: none"> Layer2: Ethernet, Ethernet/VLAN, Ethernet/MPLS Layer3: None, IPv4, IPv6 PTP Protocol Analysis <ul style="list-style-type: none"> Statistics of IEEE 1588 messages and message rate. Logged IEEE 1588 events: Clock state transitions, State transition events, Faults and Changes in grand-master clock IEEE 1588 messages captured and exported in Wireshark format
Sync Test Application (MT1000A-005 and MU100090B are required) When synchronized with reference time signal (GNSS or 1PPS)	<p>Time/Phase Synchronization Test</p> <p>Supported Interface: GigE, 10 GigE, 25 GigE (only optical interface)</p> <ul style="list-style-type: none"> Time Error is measured by a parameter set by protocol emulation. (However, the delay mechanism is supported only by Delay request.) 1 PPS TE <ul style="list-style-type: none"> Method: Comparing 1 PPS signal from the network with reference 1 PPS (error ± 5 ns (typ.)) Test Items: max TE , cTE, dTE, MTIE, TDEV Packet TE <ul style="list-style-type: none"> Method: The timestamp in the message packet is compared with either GNSS-synchronized UTC, or with the phase of the 1 PPS reference (time stamping error ± 30 ns (Without MU100090B-001 ± 35 ns)) Test Items: max TE1 , max TE4 , cTE1, cTE4, Terr, max Terr , cTE, low-pass-filtered dTE, high-pass-filtered dTE, MTIE, pktSelected TE PDV measurement: Calculates FPP in compliance with G.8261.1 Frequency deviation measurement reference signal <ul style="list-style-type: none"> Accuracy <ul style="list-style-type: none"> GbE: ± 2 ppb, 10 GbE: ± 2 ppb, 25 GbE: ± 6 ppb

IP Channel Statistics	
Supported Bit Rate	10 Mbps, 100 Mbps, 1 Gbps, 10 Gbps
Statistics	<p>Statistics for up to 230 channels, identified by user-defined combinations of:</p> <ul style="list-style-type: none"> IPv4, IPv6 or MAC address VLAN ID or MPLS label Protocol information IP next header (protocol) TCP/UDP ports <p>Traffic capacity:</p> <ul style="list-style-type: none"> 10 Mbps, 100 Mbps, 1 Gbps, 10 Gbps, line speeds: 100% line load <p>Available Information per channel:</p> <ul style="list-style-type: none"> Frame count/rate, Throughput, Byte count, MPLS frames, IP frame/packet size distribution, IP header bytes, IP fragments, TTL threshold violations, IP packet count/rate, IP bytes, IP throughput, IP header errors, TCP/UDP bytes, TCP/UDP packet count/rate, Throughput, TCP/UDP errored packets, Undersize frames, Oversize frames

Ethernet Testing Specifications

Ethernet Frame Capture		
Model No.	MU100010A1	MU100011A
Capture Buffer Size	1 Mbytes to 128 Mbytes (10 Mbps, 100 Mbps, 1 Gbps, 10 Gbps) When capture buffer full: Stop or Wrap	1 Mbytes to 128 Mbytes (10 Mbps, 100 Mbps, 1 Gbps, 10 Gbps) 512 kbytes (25 Gbps, 40 Gbps, 100 Gbps) When capture buffer full: Stop or Wrap
Capture Frame Slicing	If activated capture frame is first 64 bytes or 128 bytes of each frame (ignores rest of the frame)	
Timestamp Resolution	100 ns	
Include Tx Frame	On/Off	
Capture Trigger	Manual, On error, Field match Trigger position: Top, Middle	
Error Trigger	Fragmented frames, Oversize frames, Undersized frames, Undersized and oversized frames, FCS errored frames, Any type	
Trigger Field Pattern Data	Enabled when capture trigger setting is "Field match" • Offset: 0 to 15999 bytes • Length: 1 bytes to 16 bytes	
Capture Data	Pcap format for display in Wireshark	

Wireshark® is a registered trademark of the Wireshark Foundation.

Discovery	
Function	The Auto Discovery feature allows a local Network Master Pro user to discover other remote Network Master Pro units on the network to complete testing. The local user can manage multiple testers remotely without a dedicated network connection. Support IP version: IPv4
Setting	Network: Src MAC Address, Src IP Address, Network Mask, Gateway, DHCP Connection Security: Password VLAN: OFF, 1, 2 Frame Capture: On/Off

MPLS/MPLS –TP	
Number of MPLS Header	Up to 8 MPLS headers set by user
Parameters per MPLS Header	User-defined label, Exp and TTL fields in each MPLS header • Address increment, Decrement and Random generation An EoMPLS (Ethernet over MPLS) or PWE3 (Pseudo-wire emulation edge-to-edge) label (RFC 4448 control word) can be added. MPLS can only transport VLAN if EoMPLS activated.
Statistics	• Number of labels (Max./Min.) • Number of MPLS-TP frames • Last received MPLS-TP label/priority/TTL
OAM (MPLS-TP)	ITU-T G.8113.1 comply Supported OAM messages • ITU-T Y.1731: CCM, LBM, LBR, LTM, LTR, AIS, LCK, TST, MCC, LMM, LMR, 1DM, DMM, DMR, EXM, EXR, VSM, VSR, SLM, SLR • IEEE 802.1ag: CCM, LBM, LBR, LTM, LTR

PBB (Mac-in-Mac MiM)	
Programmable Field	B-tag, I-tag, MAC destination and source addresses
Result	Number of PBB frames, Last received B-tag VLAN ID, Last received B-tag priority, Last received I-tag priority, Last received I-tag service ID
OAM	Supported OAM messages • ITU-T Y.1731: CCM, LBM, LBR, LTM, LTR, AIS, LCK, TST, MCC, LMM, LMR, 1DM, DMM, DMR, EXM, EXR, VSM, VSR, SLM, SLR • IEEE 802.1ag: CCM, LBM, LBR, LTM, LTR

Ethernet Testing Specifications

Ethernet OAM	
OAM Standards Supported	<ul style="list-style-type: none"> • ITU-T Y.1731 (Service layer OAM) • IEEE 802.1ag (Connectivity layer OAM) • IEEE 802.3 (formerly IEEE 802.3ah) (Access link OAM)
Messages Supported	Generates and receives following OAM messages. Supported OAM messages <ul style="list-style-type: none"> • ITU-T Y.1731: CCM, LBM, LBR, LTM, LTR, AIS, LCK, TST, MCC, LMM, LMR, 1DM, DMM, DMR, EXM, EXR, VSM, VSR, SLM, SLR • IEEE 802.1ag: CCM, LBM, LBR, LTM, LTR • IEEE 802.3ah: Information, Variable request, Variable response, Loopback control
IEEE 802.3ah Function	<ul style="list-style-type: none"> • Discovery • Loopback activate
Statistics	<ul style="list-style-type: none"> • Number of each message generated/received

Ping Test	
Function	For Connectivity and Configuration check <ul style="list-style-type: none"> • Round Trip Time (RTT) • Supports IPv4 and IPv6 addressing • Answer incoming ping requests (On/Off)

Reflector	
Function	The following parameters are user selectable: <ul style="list-style-type: none"> • Reflector MAC/IP address • Swap all MAC addresses or one specific MAC address • Swap IPv4/IPv6 addresses • Swap port numbers on UDP/TCP frames • Force ACK on TCP frames • Answer incoming ARP, Ping requests

Traceroute	
Function	Trace IP route over IP network <ul style="list-style-type: none"> • User-defined Max. number of hops (1 to 255) Information per hop: Ping time (Min./Max./Avg.), Number of ping timeouts

Cable Test	
Function	Required Options: MU100010A-001, MU100011A-001, MU100011A-003 Identifies cable faults like short circuits, or breaks in wire pair, and displays distance from instrument to fault Support Cable: category 5/5e, 6/6a

10G WAN-PHY	
WAN Mode	10 Gbps Ethernet (normal)
Terminology	SDH or SONET
Error Generation	SDH: A1A2, B1, B2, MS-REI, B3, HP-REI SONET: A1A2, B1, B2, REI-L, B3, REI-P
Alarm Generation	SDH: LOF, OOF, MS-AIS, MS-RDI, MS-TIM, AU-AIS, AU-LOP, HP-PLM, HP-UNEQ, HP-TIM, HP-RDI, LCD SONET: LOF, SEF, TIM-S, AIS-L, RDI-L, AIS-P, LOP-P, TIM-P, PLM-P, UNEQ-P, RDI-P
Error Measurement	SDH: A1A2, B1, B2, MS-REI, B3, HP-REI SONET: A1A2, B1, B2, REI-L, B3, REI-P G.826, G.828+G.829 or M.2101.1 (M.2100) error performance parameters are calculated
Alarm Detection	SDH: LOS, LOF, OOF, MS-AIS, MS-RDI, MS-TIM, AU-AIS, AU-LOP, HP-PLM, HP-UNEQ, HP-TIM, HP-RDI, LCD, LSS SONET: LOS, LOF, SEF, TIM-S, AIS-L, RDI-L, AIS-P, LOP-P, TIM-P, PLM-P, UNEQ-P, RDI-P, LCD-P, LSS
Overhead Byte Functionality	Generation of user-defined overhead bytes Capture and display of current overhead bytes

OTN Testing Specifications

Common		
Model No.	MU100010A1	MU100011A
Framing	OTU2, OTU2e, OTU1e, OTU2f, OTU1f, OTU1	OTU4, OTU3, OTU3e1, OTU3e2, OTU2, OTU2e, OTU1e, OTU2f, OTU1f, OTU1
Test Configuration	BERT, RTD, APS	
Transmitter Clock	<ul style="list-style-type: none"> Internal clock accuracy: ± 4.6 ppm, Clock offset: ± 50 ppm (1-ppm steps) Received clock TTL level external 2 MHz clock SETS (E1: 2.048 Mbps), BITS (DS1: 1.544 Mbps) Signal from optional GPS receiver 	<ul style="list-style-type: none"> Internal clock accuracy: ± 4.6 ppm, Clock offset: ± 200 ppm (0.1-ppm steps) Received clock TTL level external 2 MHz clock SETS (E1: 2.048 Mbps), BITS (DS1: 1.544 Mbps) Signal from optional GPS receiver
Receive Signal Rate	± 50 ppm Frequency deviation indication resolution: ± 1 ppm	± 200 ppm Frequency deviation indication resolution: ± 0.1 ppm
Scrambling	Complies with ITU-T G.709	

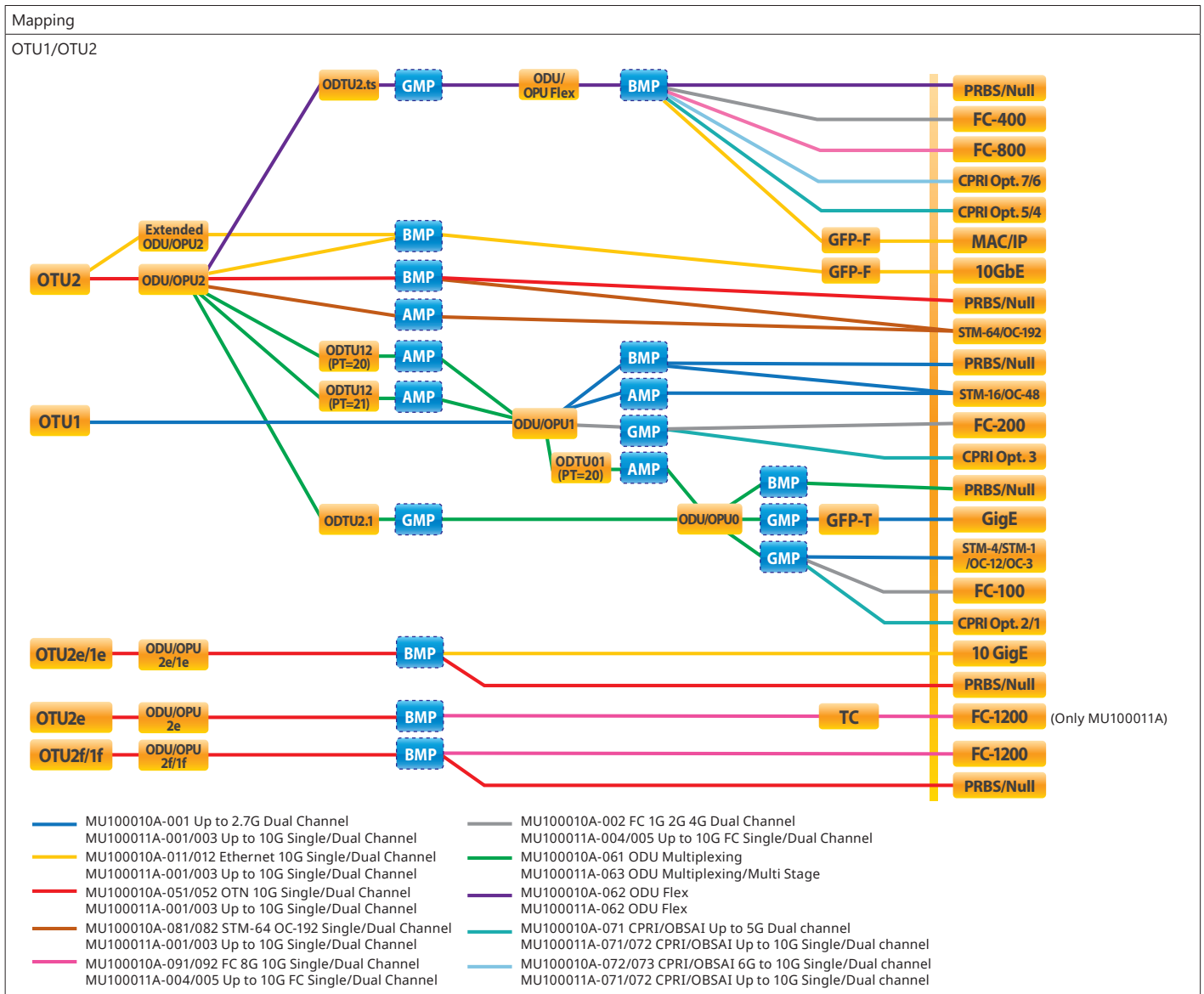

OTN Testing Specifications

OTU3

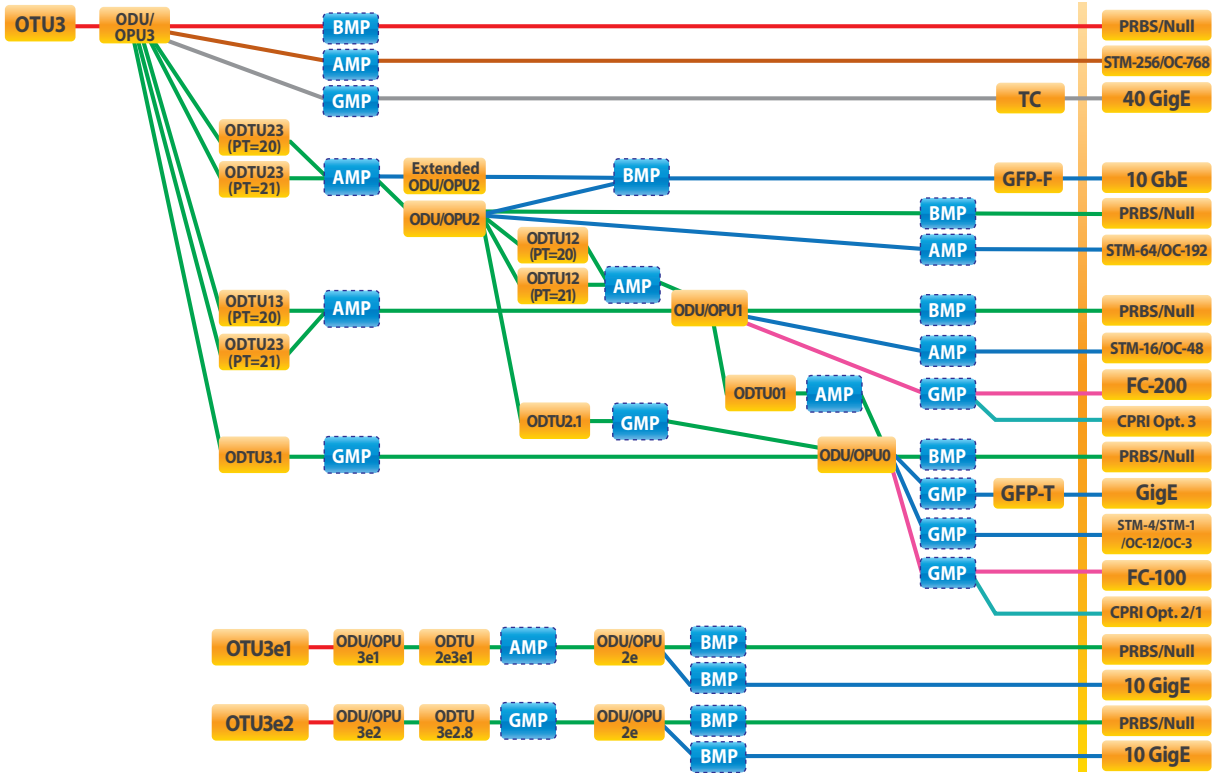

- MU100011A-053 OTN 40G Single Channel
- MU100011A-063 ODU Multiplexing/Multi Stage
- MU100011A-001/003 Up to 10G Single/Dual Channel
- MU100011A-004/005 Up to 10G FC Single/Dual channel
- MU100011A-071/072 CPRI/OBSAI Up to 10G Single/Dual Channel
- MU100011A-013 Ethernet 40G Single Channel
- MU100011A-083 STM-256/OC-768 Client Signal

OTU4

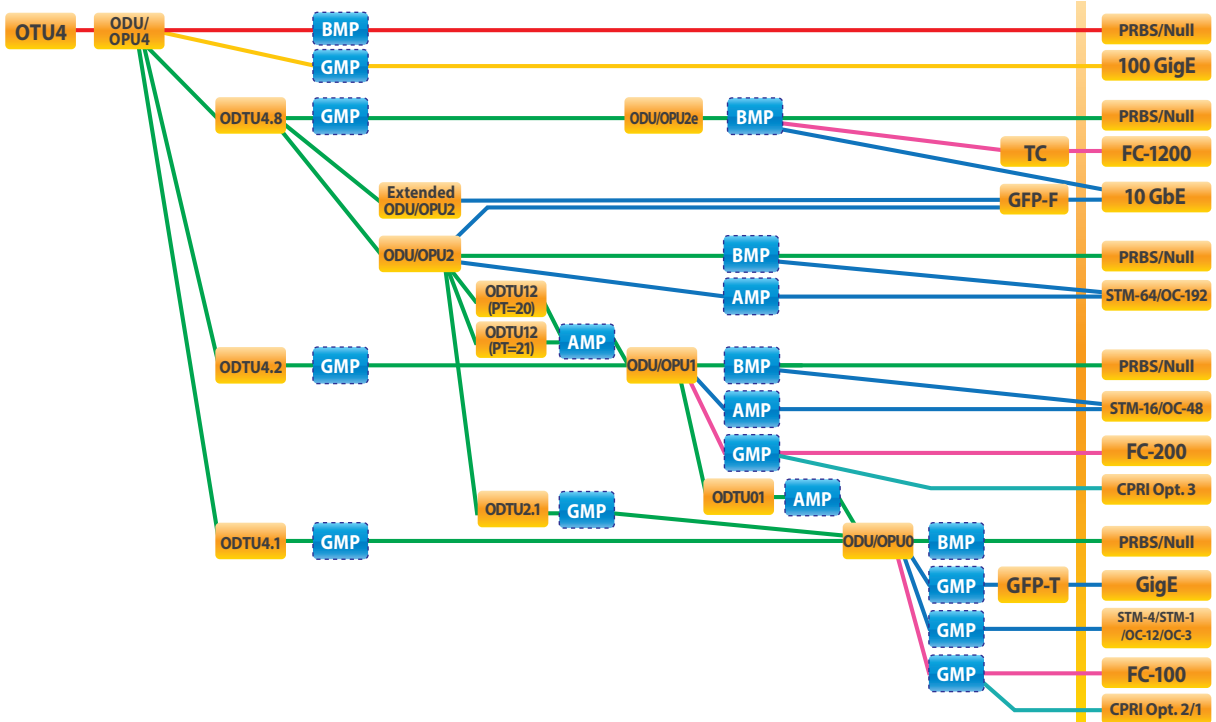

- MU100011A-055 OTN 100G Single Channel
- MU100011A-063 ODU Multiplexing/Multi Stage
- MU100011A-001/003 Up to 10G Single/Dual Channel
- MU100011A-004/005 Up to 10G FC Single/Dual Channel
- MU100011A-071/072 CPRI/OBSAI Up to 10G Single/Dual Channel
- MU100011A-015 Ethernet 100G Single Channel

OTN Testing Specifications

OTN Configuration		
Model No.	MU100010A1	MU100011A
OTN Alarms	<p>Detected alarms</p> <ul style="list-style-type: none"> • OTU layer: OTU-AIS, LOF, OOF, LOM, OOM, SM-TIM, SM-BIAE, SM-BDI, SM-IAE • ODU layer: LOS, ODU-AIS, ODU-OCI, ODU-LCK, PM-TIM, PM-BDI, FSF, FSD, BSF, BSD • ODU multiplexing: ODU-LOFLOM, ODU-OOF, OOM, ODU-AIS, ODU-OCI, ODU-LCK, PM-TIM, PM-BDI, MSIM • OPU layer: PLM, OPU-MSIM, Client-AIS, CSF, LSS • TCM: TCMi-TIM, TCMi-BIAE, TCMi-BDI, TCMi-IAE, TCMi-LTC (i = 1 to 6) <p>Generated alarms</p> <ul style="list-style-type: none"> • OTU layer: OTU-AIS, OTU-OOF/LOF, OOM/LOM, SM-TIM, SM-BIAE, SM-BDI, SM-IAE • ODU layer: ODU-AIS, ODU-OCI, ODU-LCK, PM-TIM, PM-BDI, FSF, FSD, BSF, BSD • ODU multiplexing: OOF/LOF, OOM/LOM, ODU-AIS, ODU-LCK, PM-TIM, PM-BDI, FSF, FSD, BSF, BSD • OPU layer: Client-AIS, CSF • TCM: TCMi-TIM, TCMi-BIAE, TCMi-IAE, TCMi-BDI, TCMi-LTC (i = 1 to 6) 	<p>Detected alarms</p> <ul style="list-style-type: none"> • OTU layer: OTU-AIS, LOF, OOF, LOM, OOM, SM-TIM, SM-BIAE, SM-BDI, SM-IAE • ODU layer: LOS, ODU-AIS, ODU-OCI, ODU-LCK, PM-TIM, PM-BDI, FSF, FSD, BSF, BSD • ODU multiplexing: ODU-LOFLOM, ODU-OOF, OOM, ODU-AIS, ODU-OCI, ODU-LCK, PM-TIM, PM-BDI, MSIM • OPU layer: PLM, OPU-MSIM, Client-AIS, CSF, LSS • TCM: TCMi-TIM, TCMi-BIAE, TCMi-BDI, TCMi-IAE, TCMi-LTC (i = 1 to 6) <p>Generated alarms</p> <ul style="list-style-type: none"> • OTL: LOF, OOF, OOR, LOR, ILA/OLA (OTU4, OTU3, OTU3e1, OTU3e2) <p>Generated alarms</p> <ul style="list-style-type: none"> • OTU layer: OTU-AIS, OTU-OOF/LOF, OOM/LOM, SM-TIM, SM-BIAE, SM-BDI, SM-IAE • ODU layer: ODU-AIS, ODU-OCI, ODU-LCK, PM-TIM, PM-BDI, FSF, FSD, BSF, BSD • ODU multiplexing: OOF/LOF, OOM/LOM, ODU-AIS, ODU-LCK, PM-TIM, PM-BDI, FSF, FSD, BSF, BSD • OPU layer: Client-AIS, CSF • TCM: TCMi-TIM, TCMi-BIAE, TCMi-IAE, TCMi-BDI, TCMi-LTC (i = 1 to 6) • OTL: LOF, OOF, OOR, LOR (OTU4, OTU3, OTU3e1, OTU3e2)
OTN Errors	<p>Detected errors</p> <ul style="list-style-type: none"> • OTU layer: FAS, MFAS, SM-BEI, SM-BIP8, FEC-Correctable, FEC-Uncorrectable • ODU layer: PM-BIP8, PM-BEI • OPU layer: Pattern error • GMP error: CRC8 error, CRC5 error • GFP errors: <ul style="list-style-type: none"> • cHEC corrected, cHEC uncorrectable, tHEC corrected, tHEC uncorrectable, CSF Signal, CSF Sync, Invalid GFP Frame, Superblock CRC, eHEC corrected, eHEC uncorrectable, FCS, CMF Sync, CMF Signal, SSF, PTI Mismatch, UPI Mismatch • TCM: TCMi-BEI, TCMi-BIP-8 (i = 1 to 6) <p>Generated errors</p> <ul style="list-style-type: none"> • OTU layer: Bit all, FAS, OTU-FAS, MFAS, SM-BIP8, SM-BEI • ODU layer: PM-BIP8, PM-BEI, ODU-FAS • TCMi-BIP8, TCMi-BEI (i = 1 to 6) • Pattern error • GMP: CRC8, CRC5, Invalid JC1, Invalid JC2, Invalid JC1&JC2 • GFP: cHEC, tHEC, Superblock CRC, eHEC, FCS, CMF Inserted Error bits are editable. 	<p>Detected errors</p> <ul style="list-style-type: none"> • OTU layer: FAS, MFAS, SM-BEI, SM-BIP8, FEC-Correctable, FEC-Uncorrectable • ODU layer: PM-BIP8, PM-BEI • OPU layer: Pattern error • GMP error: CRC8 error, CRC5 error • GFP errors: <ul style="list-style-type: none"> • cHEC corrected, cHEC uncorrectable, tHEC corrected, tHEC uncorrectable, CSF Signal, CSF Sync, Invalid GFP Frame, Superblock CRC, eHEC corrected, eHEC uncorrectable, FCS, CMF Sync, CMF Signal, SSF, PTI Mismatch, UPI Mismatch • TCM: TCMi-BEI, TCMi-BIP-8 (i = 1 to 6) • OTL: MFAS, LLM (OTU4, OTU3, OTU3e1, OTU3e2) <p>Generated errors</p> <ul style="list-style-type: none"> • OTU layer: Bit all, FAS, OTU-FAS, MFAS, SM-BIP8, SM-BEI • ODU layer: PM-BIP8, PM-BEI, ODU-FAS • TCMi-BIP8, TCMi-BEI (i = 1 to 6) • Pattern error • GMP: CRC8, CRC5, Invalid JC1, Invalid JC2, Invalid JC1&JC2 • GFP: cHEC, tHEC, Superblock CRC, eHEC, FCS, CMF Inserted Error bits are editable. • OTL: MFAS, LLM (OTU4, OTU3, OTU3e1, OTU3e2)
Error Performance	• G.8201/M.2401 analysis of received signal based on detected errors and alarms: BBE, BBER, SES, SESR, UNAV	
Justification Analysis	<p>Count</p> <ul style="list-style-type: none"> • AMP: Positive (+1), Positive (+2), Negative (-1), Offset (ppm) • GMP: CRC8 Error, CRC5 Error, Inc, Inc > 1, Inc > 2, Inc Over, Dec, Dec > 1, Dec > 2, Dec Over, Offset (ppm), Cm (t) Max., Cm (t) Min. 	
BER Test Pattern	<p>Pattern generation and detection for bulk test patterns:</p> <ul style="list-style-type: none"> • Test patterns: PRBS 9, PRBS 11, PRBS 15, PRBS 20, PRBS 23, PRBS 29, PRBS 31, Null <p>PRBS patterns can be inverted.</p> <ul style="list-style-type: none"> • User-defined patterns (Pattern length: 2048 bits, 32 bits) 	
FEC Test	ITU-T O.182 Random error insertion	
Overhead	<p>User-editable header bytes</p> <ul style="list-style-type: none"> • OTU layer: FAS, SM, GCC0, RES • ODU layer: PM, FTFL, APS/PCC, GCC1, GCC2, RES, EXP, TCMi (i = 1 to 6) • OPU layer(s): PSI <p>Capture and display current overhead bytes</p> <ul style="list-style-type: none"> • The following signals are decoded: TTI (SM, PM, TCMi (i = 1 to 6) of high-order, FTFL, PT) 	

OTN Testing Specifications

OTL Skew	—	OTU4, OTU3, OTU3e1, OTU3e2 • Insertion Bits: 0 to 32000 (LLD) • Detection Relative skew, Marker map
Client Signal	Ethernet functionality is supported for Ethernet signals embedded in selected ODU-n (Requires MU100010A-061, MU100010A-062 and MU100010A-001/011/012) SDH/SONET functionality is supported for SDH/SONET signals embedded in selected ODU-n (Requires MU100010A-061 and MU100010A-001/081/082) Fibre Channel functionality is supported for Fibre Channel signals embedded in selected ODU-n (Requires MU100010A-061 and MU100010A-002/091/092)	Ethernet functionality is supported for Ethernet signals embedded in selected ODU-n (Requires MU100011A-062, MU100011A-063 and MU100011A-001/003/013/015) SDH/SONET functionality is supported for SDH/SONET signals embedded in selected ODU-n (Requires MU100011A-063 and MU100011A-001/003/083) Fibre Channel functionality is supported for Fibre Channel signals embedded in selected ODU-n (Requires MU100011A-063 and MU100011A-004/005)
Through Mode	<ul style="list-style-type: none"> • Transparent mode • OH overwrite mode The OTU, ODU and OPU overhead can be changed. The FEC encoder and decoder can be set On/Off in any mode	

OTN Results	
Status	Current information on: <ul style="list-style-type: none"> • Alarms and errors on monitored line • Input level indication for optical signals • Frequency • Frequency deviation
Statistics	User-defined measurement resolution: 1, 2, 5, 10, 15, 30 s, 1, 5, 10, 15, 30 min, 1, 2, 4, 6, 12 h Logged information: Alarms (s), Errors (count or count and ratio), Client Frequency, Deviation
APS	APS (Automatic Protection Switching) test and analysis <ul style="list-style-type: none"> • APS switching time is measured. A switching time exceeding the user-defined threshold is highlighted. • Start and stop triggers can be selected independently. • Trigger events can be selected from the high-order OTU and ODU, Pattern bit error, LOS (Loss of Signal). • Switching time, Switching count, Pass/Fail, Minimum, Maximum and Average can be displayed. • APS switching time measurement resolution: 0.1 ms
Round Trip Delay (Propagation Time) Measurement	Resolution: 0.1 μ s Measured Max. time: 10.0 s Interval: 0.5, 1, 2, 5, 10 s
Tributary Scan	Supports up to 10 Gbps Detected alarms: OTU-AIS, LOF, OOF, LOM, OOM, SM-BIAE, SM-BDI, SM-IAE, ODU-AIS, ODU-OCI, ODU-LCK, PM-BDI, LOFLOM

Mobile xHaul Testing Specifications

Common		
Model No.	MU100010A1	MU100011A
Bit Rate	CPRI: 614.4, 1228.8, 2457.6, 3072.0, 4915.2, 6144.0, 9830.4, 10137.6 Mbps OBSAI: 768, 1536, 3072.0, 6144.0 Mbps eCPRI/RoE (IEEE1914.3): 10M/100M/1000 Mbps, 1 Gbps, 10 Gbps	CPRI: 614.4, 1228.8, 2457.6, 3072.0, 4915.2, 6144.0, 9830.4, 10137.6, 12165.12, 24330.24 Mbps OBSAI: 768, 1536, 3072.0, 6144.0 Mbps eCPRI/RoE (IEEE1914.3): 10M/100M/1000 Mbps, 1 Gbps, 10 Gbps, 25 Gbps, 40 Gbps, 100 Gbps
Test Configuration	CPRI/OBSAI BERT, CPRI Pass Through, eCPRI/RoE BERT	

CPRI/OBSAI BER Test		
Model No.	MU100010A1	MU100011A
Port Mode	Off, Normal, Through (CPRI Link)	
Transmitter Clock	Reference Clock <ul style="list-style-type: none"> • Internal clock • External clock • BITS • SETS • 2 MHz • 10 MHz • GPS • Received clock 	
Frequency Offset	±100 ppm, 1-ppm steps	±200 ppm, 0.1-ppm steps
Content	Unframed, CPRI Link, OBSAI Link	
Pattern	PRBS 15, PRBS 20, PRBS 23, PRBS 29, PRBS 31, User 32 bits*, Off *: Option 9 and Option 10 can be set in 8-bit units	
CPRI		
Bit Rate	614.4, 1228.8, 2457.6, 3072.0, 4915.2, 6144.0, 9830.4, 10137.6 Mbps	614.4, 1228.8, 2457.6, 3072.0, 4915.2, 6144.0, 9830.4, 10137.6, 12165.12, 24330.24 Mbps
FEC	Not supported	Not supported: CPRI Option 1, 2, 3, 4, 5, 6, 7, 8 Supported: CPRI Option 9, 10
CPRI Link	Start up: Enabled, Disabled Role: Master, Slave Protocol version: 1, 2 HDLC rate: no HDLC, 240, 480, 960, 1920, 2400 kbit/s, Highest possible Ethernet: On, Off; Pointer: 20 to 63	
Alarm Insertion	Signal Loss, LOS, LOF, LSS, Remote-LOS, Remote-LOF, RAI, SDI, Reset	
Error Insertion	Item: LCV, SHV, K30.7, Pattern error, FEC Symbol Error Insertion timing: Manual, Rate	
Alarm Detection	Signal loss, LOS, LOF, LSS	
Error Detection	LCV, SHV, K30.7, Pattern error, FEC Symbol Error	
FEC Error Detection	LOFA, Corr. CW, Uncorr. CW, FEC Symbol Error	
Remote Status	Remote LOS, Remote LOF, RAI, SDI, Reset	
Link	Rx: Protocol version, HDLC rate, Pointer P Tx: Protocol version, HDLC rate, Pointer P	
Statistics	Alarms: Signal loss, LOS, LOF, LSS, Remote LOS, Remote LOF, RAI, SDI, Reset Errors: LCV, SHV, K30.7, Pattern error, FEC Symbol Error Frames count: Rx hyper frame, Rx code words, Tx hyper frame, Tx code words Delay: Delay, Average Delay, Min. Delay, Max. Delay Measurement count	
OBSAI		
Bit Rate	768, 1536, 3072.0, 6144.0 Mbps	
OBSAI Link	Tx: Force idle, Scramble seed, RP3 address, RP3 type Rx: Forced scrambler seed, Rx Filter, Scramble seed, RP3 address, RP3 type	
Alarm Insertion	Signal Loss, LOF, No message, LSS	
Error Insertion	Item: LCV, K30.7, Pattern error Insertion timing: Manual, Rate	
Alarm Detection	Signal Loss, LOF, No message, LSS	
Error Detection	LCV, K30.7, Pattern error	
Link	Rx: Sync state	
Statistics	Alarms: Signal loss, LOF, LSS Errors: LCV, K30.7, Pattern error Frames count: Tx/Rx Message Groups Delay: Delay, Average Delay, Min. Delay, Max. Delay Measurement count	

Mobile xHaul Testing Specifications

CPRI/OBSAI APS	<p>APS (Automatic Protection Switching) test and analysis</p> <ul style="list-style-type: none"> • APS switching time is measured. A switching time exceeding the user-defined threshold is highlighted. • Trigger events (user selectable) • Alarm: Signal Loss, LOS(CPRI), LOF • Error: LCV, SHV(CPRI), Pattern error • Remote Alarm(CPRI): Remote LOS, Remote LOF, RAI, SDI, Reset • Switching time, Switching count, Pass/Fail, Minimum, Maximum and Average can be displayed. • APS switching time measurement resolution: 1 μs
----------------	--

CPRI Pass Through		
Model No.	MU100010A1	MU100011A
Port Mode	Off, Normal	
Bit Rate	614.4, 1228.8, 2457.6, 3072.0, 4915.2, 6144.0, 9830.4, 10137.6 Mbps	
Statistics	Alarms: Signal loss, LOS, LOF, LSS, Remote LOS, Remote LOF, RAI, SDI, Reset Errors: LCV, SHV, K30.7, Pattern error	

eCPRI/RoE (IEEE1914.3) BER Test (Setting)		
Model No.	MU100010A1	MU100011A
Frame Length	eCPRI: 50 byte to 16000 byte RoE: 51 byte to 16000 byte	
eCPRI Frame Configuration	<ul style="list-style-type: none"> • Transmitting mode: Normal, Burst • Variable line rate traffic generation, up to full line rate • Line load profile: Constant, Ramp • Traffic duration: Continuous, Programmable number of seconds or frames • Frame sizes: Constant • Protocol Stack Ethernet-eCPRI, Ethernet-IPv4-UDP-eCPRI, Ethernet-IPv6-UDP-eCPRI, Ethernet-VLAN-eCPRI, Ethernet-VLAN-IPv4-UDP-eCPRI, Ethernet-VLAN-IPv6-UDP-eCPRI, • eCPRI frame parameter <ul style="list-style-type: none"> • Common Header: Following the Message Type can be chosen IQ Data, Bit Sequence, Real-Time Control Data, Generic Data Transfer, Remote Memory Access, One-way Delay Measurement, Remote Reset, Event Indication, User Defined, None • Message Header: Change of Message Type • Payload: PRBS31 • Increment, Decrement and Random: PC_ID, SEQ_ID, RTC_ID, RESET_ID 	
RoE (IEEE1914.3) Frame Configuration	<ul style="list-style-type: none"> • Transmitting mode: Normal, Burst • Variable line rate traffic generation, up to full line rate • Line load profile: Constant, Ramp • Traffic duration: Continuous, Programmable number of seconds or frames • Frame sizes: Constant • Protocol Stack Ethernet-RoE, Ethernet-VLAN-RoE • RoE Frame setting <ul style="list-style-type: none"> • Common Header: Following the Sub Type can be chosen RoE Control sub type, RoE Structure-agnostic data sub type, RoE Structure-aware CPRI data sub type, RoE Slow C&M CPRI sub type, RoE Native time domain data sub type, RoE Native frequency domain data sub type, RoE Native PRACH data sub type, User Defined, None • Flow ID: Fixed, Increment, Decrement and Random • Ordering info: Fixed, Increment, Decrement and Random <ul style="list-style-type: none"> • Sub Header: Choice of the Sub Type • Payload: PRBS31 	
VLAN, ARP, IP/UDP Address Setting	<ul style="list-style-type: none"> • Two VLAN tags supported • Generate pause frames, Respond to pause frames • Answer incoming ARP, Ping requests (On/Off) <p>The following items can also be set only when eCPRI is selected.</p> <ul style="list-style-type: none"> • Configurable IP and Ethernet source and destination addresses (supports IPv4 and IPv6 addressing) <ul style="list-style-type: none"> IPv4: Fixed, DHCP, DNS IPv6: Fixed, NDP • Address increment, Decrement and Random generation supported • User programmable UDP port number • UDP check sum: Automatic 	
Transmit Signal Clock Sources	Internal, Received clock, 2-MHz signal, SETS (E1: 2.048 Mbps), BITS (DS1: 1.544 Mbps), PTP (IEEE 1588 v2) recovered clock or signal from optional GPS receiver Frequency deviation: ± 100 ppm (1-ppm steps)	Internal, Received clock, 2-MHz signal, SETS (E1: 2.048 Mbps), BITS (DS1: 1.544 Mbps), PTP (IEEE 1588 v2) recovered clock or signal from optional GPS receiver Frequency deviation: ± 200 ppm (0.1-ppm steps)

Mobile xHaul Testing Specifications

Receive Setting	User-defined expected preamble length: 3 bytes to 15 bytes User-defined IFG lower threshold: 8 bytes to 15 bytes (RJ45 port only) User-defined Jumbo frame size upper limit: 1519 bytes to 16000 bytes	
Error Generation	IFG for Ethernet (RJ45 port only), FCS, Preamble, Error symbol/block, Wrong IP check sum, Fragmented IP, Wrong layer 4 check sum, PRBS bit error, BER test sequence error	
Alarm Generation	No link, Remote fault	
Link Fault Signaling (LFS) Emulation	—	10 Gbps, 25 Gbps, 40 Gbps, 100 Gbps
SyncE Protocol Emulation	<ul style="list-style-type: none"> • Support Interfaces: 10 Mbps (Electric), 100 Mbps (Electric/Optical), 1 Gbps (Electric/Optical), 10 Gbps (Optical), 25 Gbps (Optical) • Signal generation for Quality Level (QL) specified by SyncE function • Analysis of QL indicated in received Ethernet signal with alarm at missing QL indications. • SyncE results: SSM Rx count and rate, SSM Tx count, Indicated QL statistics, SSF seconds • ESMC messages captured and exported in Wireshark format. 	
IEEE 1588 v2 Protocol Emulation	<ul style="list-style-type: none"> • Support Interface: 10 Mbps (Electric), 100 Mbps (Electric/Optical), 1 Gbps (Electric/Optical), 10 Gbps (Optical), 25 Gbps (Optical) • Each port of the Ethernet interface can act as a timing master or a timing slave independently. • Supported profiles: G.8265.1, G.8275.1, G.8275.2, User Defined • When acting as master in Unicast (G.8265.1) mode, one slave is accepted at a time. • If the slave requires 32, 64, or 128 Sync messages per second, IEEE 1588-2008 paragraph 7.7.2.1 specifying 90% confidence interval is not supported. <p>Configurable parameters</p> <ul style="list-style-type: none"> Domain: 0 to 255 Step Mode: One-step, Two-step Delay Mechanism: Delay request/response, Peer delay Negotiation: On/Off (Unicast only) Clock Source: Internal or UTC locked with GPS Clock Identify Priority#1, #2, Class, Time Source, Accuracy Index: 0 to 255 Announce Interval: 1/8 to 32 s Announce Timeout: 2 to 255 s Sync Interval: 1/128 to 32 s Minimum Delay Request Interval: 1/128 to 32 s Unicast Duration: 60 s to 1,000 s <ul style="list-style-type: none"> • Protocol Stack <ul style="list-style-type: none"> Layer2: Ethernet, Ethernet/VLAN, Ethernet/MPLS Layer3: None, IPv4, IPv6 • PTP Protocol Analysis <ul style="list-style-type: none"> Statistics of IEEE 1588 messages and message rate. Logged IEEE 1588 events: Clock state transitions, State transition events, Faults and Changes in grand-master clock IEEE 1588 messages captured and exported in Wireshark format 	
E-OAM	<p>Standards Supported</p> <ul style="list-style-type: none"> • ITU-T Y.1731 (Service layer OAM) • IEEE 802.1ag (Connectivity layer OAM) • IEEE 802.3 (formerly IEEE 802.3ah) (Access link OAM) <p>Generates and receives following OAM messages.</p> <ul style="list-style-type: none"> • ITU-T Y.1731: CCM, LBM, LBR, LTM, LTR, AIS, LCK, TST, MCC, LMM, LMR, 1DM, DMM, DMR, EXM, EXR, VSM, VSR, SLM, SLR • IEEE 802.1ag: CCM, LBM, LBR, LTM, LTR • IEEE 802.3ah: Information, Variable request, Variable response, Loopback control 	
IEEE 802.3ah Function	<ul style="list-style-type: none"> • Discovery • Loopback activate 	

Mobile xHaul Testing Specifications

eCPRI/RoE (IEEE1914.3) BER Test (Counter, Monitor)		
Model No.	MU100010A1	MU100011A
Status	<ul style="list-style-type: none"> Link status, Interface type, Jabber detected, Frames present, MPLS/EoMPLS/VLAN, Speed, Full or half duplex, Local clock (Ethernet 1000 Mbps), LFS LF/RF (Ethernet 10 Gbps), Signal present, Bit rate of incoming Ethernet signal, Auto negotiation complete Link partner abilities: <ul style="list-style-type: none"> Pause capable and Asymmetric pause request (not Ethernet 10 Gbps and more), Remote fault, Speed/Duplex Indicators for Utilization, Throughput and Errored frames Signal level indication for optical Ethernet interfaces LFS local fault, LFS remote fault, High BER, LOA (10 Gbps) Invalid sync header, Invalid alignment marker, BIP error, Invalid block (10 Gbps) 	<ul style="list-style-type: none"> Link status, Interface type, Jabber detected, Frames present, MPLS/EoMPLS/VLAN, Speed, Full or half duplex, Local clock (Ethernet 1000 Mbps), LFS LF/RF (Ethernet 10 Gbps), Signal present, Bit rate of incoming Ethernet signal, Auto negotiation complete Link partner abilities: <ul style="list-style-type: none"> Pause capable and Asymmetric pause request (not Ethernet 10 Gbps and more), Remote fault, Speed/Duplex Indicators for Utilization, Throughput and Errored frames Signal level indication for optical Ethernet interfaces LFS local fault, LFS remote fault, High BER, LOA (10 Gbps, 25 Gbps) Invalid sync header, Invalid alignment marker, BIP error, Invalid block (10 Gbps, 25 Gbps)
Resolution	<ul style="list-style-type: none"> User-defined resolution for statistical measurements: 1, 2, 5, 10, 15, 30 s, 1, 5, 10, 15, 30 min, 1, 2, 4, 6, 12 h Event log: Major measurement events incl. errors and alarms are logged with 1-second resolution. 	
Performance Statistics	<ul style="list-style-type: none"> Utilization (Max./Min./Avg.), Throughput (Max./Min./Avg.), Frame rate (Max./Min./Avg.) 	
Frame Statistics	<ul style="list-style-type: none"> Total frames, Total valid frames, Unicast/Multicast/Broadcast frames, Number of pause frames Number of VLAN tagged frames, Max. number of VLAN layers detected, Last received VLAN ID, Last received VLAN priority Total errored frames, Fragmented frames, Number of oversized and undersized (runts) frames, Number of FCS errored frames 	
Burst Statistics	<ul style="list-style-type: none"> Total frames, Total valid frames, Number of burst, Total frames in bursts, Burst size (Max./Min./Avg.) 	
Frame Distribution Statistics	<ul style="list-style-type: none"> Total valid/ frames, 64 to 127, 128 to 255, 256 to 511, 512 to 1023, 1024 to 1518 byte frames, Total number of jumbo frames Frame size (Max./Min./Avg.) 	
Adjustable Threshold	Utilization, Throughput, Errored frames, Collision rate, Unicast frames, Multicast frames, Broadcast frames, Pause frames, Fragmented frames, Undersized frames (runts), Oversized frames, FCS errored frames, IFG violations (RJ45 port only), Preamble violations, BER test pattern errors, Sequence errors, Diff.Tx-Rx	
BER Test	Generation and detection of test patterns, Count of errors in received test pattern, Detection of sequence errors, loss of sequence synchronization, Frame loss count and frame loss seconds Throughput measurement results are calculated for: <ul style="list-style-type: none"> Utilization layer, Physical layer, Physical layer excluding preamble, Link layer, Network layer and Data layer Min./Max./Avg. values Performance (M.2100 type) parameters: ES, SES, ALS, UAT, AVT, EFS Test patterns: PRBS 31 User-defined resolution: 1, 2, 5, 10, 15, 30 s, 1, 5, 10, 15, 30 min, 1, 2, 4, 6, 12 h Event log: Major measurement events incl. errors and alarms are logged with 1-second resolution.	

eCPRI/RoE (IEEE1914.3) BER Test (Frame Capture)		
Model No.	MU100010A1	MU100011A
Capture Buffer Size	1 Mbytes to 128 Mbytes (10 Mbps, 100 Mbps, 1 Gbps, 10 Gbps) When capture buffer full: Stop or Wrap	1 Mbytes to 128 Mbytes (10 Mbps, 100 Mbps, 1 Gbps, 10 Gbps) 512 kbytes (25 Gbps, 40 Gbps, 100 Gbps) When capture buffer full: Stop or Wrap
Capture Frame Slicing	If activated capture frame is first 64 bytes or 128 bytes of each frame (ignores rest of the frame)	
Timestamp Resolution	100 ns	
Include Tx Frame	On/Off	
Capture Trigger	Manual, On error, Field match Trigger position: Top, Middle	
Error Trigger	Fragmented frames, Oversize frames, Undersized frames, Undersized and oversized frames, FCS errored frames, Any type	
Trigger Field Pattern Data	Enabled when capture trigger setting is Field match <ul style="list-style-type: none"> Offset: 0 to 15999 bytes Length: 1 bytes to 16 bytes 	
Capture Data	Pcap format for display in Wireshark	

Fibre Channel Testing Specifications

Common		
Model No.	MU100010A1	MU100011A
Bit Rate	1.0625 Gbps (FC-100/1GFC), 2.125 Gbps (FC-200/2GFC), 4.25 Gbps (FC-400/4GFC), 8.5 Gbps (FC-800/8GFC), 10.52 Gbps (FC-1200/10GFC)	1.0625 Gbps (FC-100/1GFC), 2.125 Gbps (FC-200/2GFC), 4.25 Gbps (FC-400/4GFC), 8.5 Gbps (FC-800/8GFC), 10.52 Gbps (FC-1200/10GFC), 14.025 Gbps (FC-1600/16GFC)
Test Configuration	FC-Performance Test, FC-BERT, FC-Reflector	

FC-BERT		
Model No.	MU100010A1	MU100011A
Port mode	Off, 1GFC, 2GFC, 4GFC, 8GFC, 10GFC	Off, 1GFC, 2GFC, 4GFC, 8GFC, 10GFC, 16GFC
Timing source	Internal, External, GPS, Received	
Topology	Point-to-point, Fabric, E-Port	
Flow Control	Credit based transmitter: On/Off Buffer-to-buffer credit configuration: 1 to 65535, Buffer-to-buffer credit and R_RDY counters, R_RDY injection	
Source	Port WWN: User define or Default ID: 000000 to FFFFFFFF	
Destination	Port WWN: User define or Default ID: 000000 to FFFFFFFF	
Primitive Sequence Protocol	Count and transmit primitive sequence: LR, LRR, NOS, OLS	
Traffic Generation	<ul style="list-style-type: none"> • 1GFC (with SOF and EOF frame delimiters and 2GFC frames), Class-3 service frames • Traffic shaping: Constant, Ramp, Burst, 2GFC frame header configuration • Frame length configuration: 3240 bytes (max.) 	
BER test	<ul style="list-style-type: none"> • Test modes: Unframed BER test, Layer 1 BER test, Layer 2 BER test • Test patterns: PRBS 9, PRBS 11, PRBS 15, PRBS 20, PRBS 23, PRBS 29, PRBS 31, HF test pattern, CSPAT, CJPAT, CRPAT, JTPAT, SPAT, 55 Hex, Fox, 32-bit user programmable, ZERO • Error injection: Bit, CRC, Symbol • Results: Pattern loss seconds, Traffic loss seconds, Bit error count, BER 	
Measurement	<ul style="list-style-type: none"> • Alarm detection: LOS, Link down, Pattern loss • Service disruption measurement: Average/Max service disruption, Number of service disruptions • Traffic statistics: Bandwidth utilization, Data rate, Frame count, Byte count, Frame size distribution, Buffer-to-buffer credit count, R_RDY count, Frame loss count, Round trip delay, Packet jitter, Bit errors, CRC errors, Symbol errors, LR, LRR, NOS, OLS 	

FC-Reflector		
Model No.	MU100010A1	MU100011A
Port mode	Off, 1GFC, 2GFC, 4GFC, 8GFC, 10GFC	Off, 1GFC, 2GFC, 4GFC, 8GFC, 10GFC, 16GFC
Timing source	Internal, External, GPS, Received	
Topology	Point-to-point, Fabric, E-Port	
Flow Control	Credit based transmitter: On/Off Buffer-to-buffer credit configuration: 1 to 65535, Buffer-to-buffer credit and R_RDY counters, R_RDY injection	
Source	Port WWN: User define or Default	
Frame Setup	Framing: SOF:Data:EOF or SOF:Header:Data:CRC:EOF	

FC-Performance Test		
Model No.	MU100010A1	MU100011A
Port mode	Off, 1GFC, 2GFC, 4GFC, 8GFC, 10GFC	Off, 1GFC, 2GFC, 4GFC, 8GFC, 10GFC, 16GFC
Timing source	Internal, External, GPS, Received	
Topology	Point-to-point, Fabric, E-Port	
Flow Control	Credit based transmitter: On/Off Buffer-to-buffer credit configuration: 1 to 65535, Buffer-to-buffer credit and R_RDY counters, R_RDY injection	
Source	Port WWN: User define or Default ID: 000000 to FFFFFFFF	
Destination	Port WWN: User define or Default ID: 000000 to FFFFFFFF	
Configuration	Test Mode: Port-to-Port, Loopback Kinds of test: Throughput, Traffic Profile, Latency, Burst, Credit Frame Size: User Defined (64, 128, 256, 512, 768, 2014, 1280, 2140, up to 3240), Stepped (40 to 3240), Constant	

SDH/SONET Testing Specifications

Common		
Model No.	MU100010A1	MU100011A
Bit Rate	Optical (SFP/SFP+): STM-1/OC-3, STM-4/OC12, STM-16/OC48, STM-64/OC192 Electrical (BNC): STM-1e, STS-3	Optical (SFP/SFP+): STM-1/OC-3, STM-4/OC-12, STM-16/OC-48, STM-64/OC-192
Test Configuration	BERT, RTD, APS	

SDH and SONET Configuration		
Model No.	MU100010A1	MU100011A
Framing	SDH: Complies with ITU-T G.707, SONET: Complies with Telcordia GR-253	
Transmitter Clock	<ul style="list-style-type: none"> Internal clock accuracy: 4.6 ppm, Clock offset: ± 50 ppm (1-ppm steps) Recovered clock TTL level external 2 MHz clock SETS (E1: 2.048 Mbps), BITS (DS1: 1.544 Mbps) 	<ul style="list-style-type: none"> Internal clock accuracy: 4.6 ppm, Clock offset: ± 200 ppm (0.1-ppm steps) Recovered clock TTL level external 2 MHz clock SETS (E1: 2.048 Mbps), BITS (DS1: 1.544 Mbps)
Receive Signal Rate	± 50 ppm Frequency deviation indication resolution: ± 1 ppm	± 200 ppm Frequency deviation indication resolution: ± 0.1 ppm
TCM Frame Format	ITU-T G.783, G.707 Annex D (TCM option 2) and Annex E, POH bytes: N1 (VC-4, VC-3), Z5 (STS-3c, STS-1), N2 (VC-12, VC-11), Z6 (VT-2, VT-1.5) TCM Access Point Identifier (Apid): 15 bytes ASCII sequence, CRC-7	
Scrambling	SDH: Complies with ITU-T G.707, SONET: Complies with Telcordia GR-253	

SDH Mapping

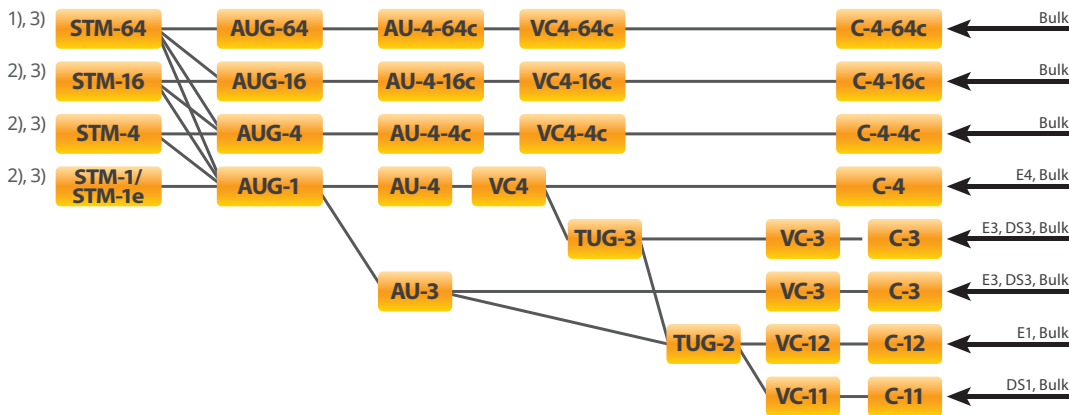

- 1) Requires MU100010A-081 or MU100010A-082
- 2) Requires MU100010A-001
- 3) Requires MU100011A-001 or MU100011A-003

SONET Mapping

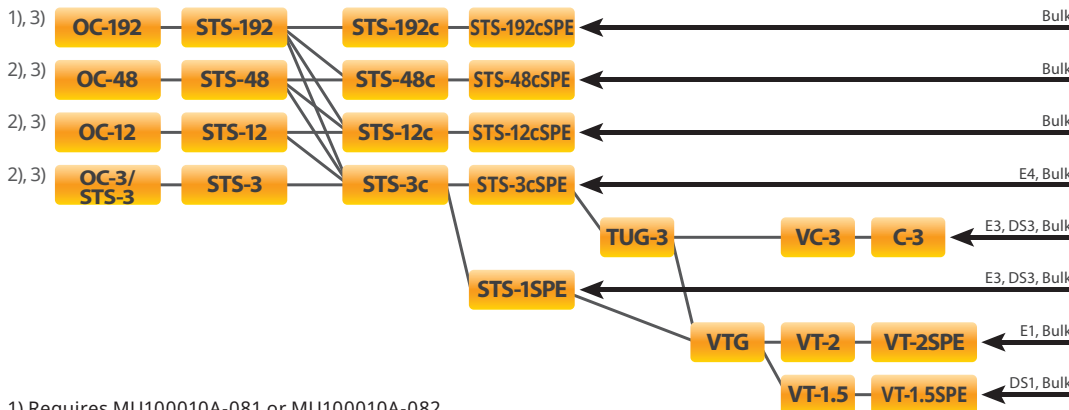

- 1) Requires MU100010A-081 or MU100010A-082
- 2) Requires MU100010A-001
- 3) Requires MU100011A-001 or MU100011A-003

SDH/SONET Testing Specifications

Alarms	<p>Detected and generated alarms</p> <ul style="list-style-type: none"> SDH: LOS, LOF, OOF, MS-AIS, MS-RDI, AU-AIS, AU-LOP, HP-PLM, HP-UNEQ, HP-TIM, HP-RDI, TU-LOM, TU-AIS, TU-LOP, LP-PLM, LP-UNEQ, LP-TIM, LP-RDI, LSS SONET: LOS, LOF, OOF, AIS-L, RDI-L, AIS-P, LOP-P, TIM-P, PLM-P, UNEQ-P, RDI-P, LOM-V, AIS-V, LOP-V, PLM-V, UNEQ-V, RDI-V, TIM-V, LSS TCM: TC-LTC, TC-TIM, TC-UNEQ, TC-AIS, TC-RDI, TC-ODI <p>Inserted alarms</p> <ul style="list-style-type: none"> Permanent Alternate: 1 to 8000 consecutive alarm frames, 1 to 8000 consecutive normal frames
Errors	<p>Detected and generated errors</p> <ul style="list-style-type: none"> SDH: A1/A2, B1, B2, MS-REI, B3, HP-REI, V5/B3, LP-REI, Pattern error, ERR trans SONET: A1/A2, B1, B2, REI-L, B3, REI-P, V5/B3, REI-V, Pattern error, ERR trans TCM: TC-IEC, TC-BIP2, TC-REI, TC-OEI <p>Error insertion</p> <ul style="list-style-type: none"> Manual: 1 to 8000 consecutive errors (excluding Pattern error) 1 to 4000 consecutive errors (for Pattern error) Continuous: 10^{-3}, 10^{-4}, 10^{-5}, 10^{-6}, 10^{-7}, 10^{-8}, 10^{-9}, 10^{-10} (The available highest rate varies depending on the error item.) Alternate: 1 to 8000 consecutive error frames, 1 to 8000 consecutive normal frames (excluding Pattern error and ERR trans) 1 to 4000 consecutive error bits, 100 to 4000 consecutive normal bits (for Pattern error)
BER Test Pattern	<p>Pattern generation and detection for O.181 bulk test pattern</p> <ul style="list-style-type: none"> Test patterns supported: PRBS 9, PRBS 11, PRBS 15, PRBS 20, PRBS 23, PRBS 29, PRBS 31 <p>PRBS patterns can be inverted.</p> <p>All 0 s, All 1 s, Alternating 1:1, Alternating 1:3, Alternating 1:7, 2 in 8</p> <p>User-defined patterns (Pattern length: up to 2048, Length step: 8-bit)</p>
Pointer	<ul style="list-style-type: none"> Support pointer events monitoring and generation Pointer test sequences: None, Single alternating, Regular + Double, Regular + Missing, Double alternating Display pointer value of receiver side Graphical display of pointer movements
Overhead	<ul style="list-style-type: none"> Generation of section/transport and path overhead bytes Display of current section/transport and path overhead bytes <p>All overhead can be decoded, including decoded J0, J1, J2 byte.</p>
Through Mode	<ul style="list-style-type: none"> Transparent mode OH overwrite mode: Can be changed SOH (SDH), TOH (SONET)

SDH and SONET Results	
Status	<p>Current information on</p> <ul style="list-style-type: none"> Alarms and errors on monitored line Input level indication for optical signals Input level indication for electrical signals Actual bit rate Frequency deviation
Statistics	<p>User-defined measurement resolution: 1, 2, 5, 10, 15, 30 s, 1, 5, 10, 15, 30 min, 1, 2, 4, 6, 12 h</p> <p>Logged information: Alarms (seconds and ratio), Errors (count or count and ratio), Pointer operations</p> <p>Event log: Major measurement events incl. errors, alarms and pointer operations are logged with 1-second resolution.</p>
Error Performance	G.826/G.828/G.829/M.2100 analysis of received signal based on detected errors and alarms: ES, SES, BBE (not M.2100), UNAV
APS	<p>APS (Automatic Protection Switching) test and analysis</p> <ul style="list-style-type: none"> APS switching time is measured. A switching time exceeding the user-defined threshold is highlighted. <ul style="list-style-type: none"> Trigger events (user selectable): <ul style="list-style-type: none"> SDH: SDH alarms and errors, pattern bit error, APS switchover SONET: SONET alarms and errors, pattern bit error, APS switchover Number of switchovers indicated by APS protocol K1/K2 bytes set and displayed <p>Resolution of APS switching time measurement, SDH</p> <ul style="list-style-type: none"> SDH events excluding VC-12 and VC-11 events, LOS (Loss of Signal): 1 μs VC-12 and VC-11 events: 0.5 ms <p>Resolution of APS switching time measurement, SONET</p> <ul style="list-style-type: none"> SONET events excluding VT-1.5 and VT-2 events, LOS (Loss of Signal): 1 μs VT-1.5 and VT-2 events: 0.5 ms
Round Trip Delay (Propagation Time) Measurement	<p>Resolution: 0.1 μs</p> <p>Measured Max. time: 10.0 s</p> <p>Interval: 0.5, 1, 2, 5, 10 s</p>

PDH/DSn Testing Specifications

E1 Common	
Model No.	MU100010A1 (No physical interface. Can set as SDH/SONET client signal.)
E1 Configuration	
Alarms	Detected and generated alarms: AIS, No frame, Distant (RDI) alarm, Pattern sync. loss, Distant (RDI) MF alarms
Errors	Detected: FAS/nFAS, CRC4, E-bit, Code, Pattern, Pattern slips, Frame slips Generated: FAS bit, FAS word, CRC-4, E-bit, Code, Pattern, Transparent Error insertion <ul style="list-style-type: none"> Manual: 1 to 255 consecutive errors (1 to 16 consecutive FAS word errors) Continuous: 10^{-2}, 10^{-3}, 10^{-4}, 10^{-5}, 10^{-6}, 10^{-7} Provoking of G.821, G.826 or M.2100 events (ES, SES etc.) (FAS, Pattern, CRC-4, E-bit) Manual slip insertion: Frame slips, Pattern slips
BER Test Pattern	Pattern generation <ul style="list-style-type: none"> Unframed or Framed: $n \times 64$ kbps in contiguous or non-contiguous channel access Supported test patterns <ul style="list-style-type: none"> PRBS 6, PRBS 7, PRBS 9, PRBS 11, PRBS 15, PRBS 20, PRBS 23, QRSS 11, QRSS 20 Fox pattern, Fox (CMA 3000), All 0, All 1, Alternating (1:1), (1:3), (1:7), (3:24) User-defined up to 32 bits (Length: 1-bit steps) User-defined up to 2048 bits (Length: 8-bit steps) All patterns can be inverted, except user-defined
CAS	CAS signaling bits can be set.
Tone and Speech Signal Insertion	Tone in one speech channel on one transmitter <ul style="list-style-type: none"> Frequency: 1 Hz to 4 kHz (1-Hz steps) Level: -70 to +3 dBm (1-dBm steps) Artificial speech signal
Speech Decode	64 kbps (ITU-T G.703): A-law according to ITU-T G.711
E1 Results	
Status	Current Information on <ul style="list-style-type: none"> Alarms and errors on monitored line Input level indication Actual bit rate Frequency deviation FAS/non-FAS and CAS bits Traffic overview: Busy/Idle indication from all 31 channels
Time Slot Monitoring	Contents of single time slot including positive/negative peak values. <ul style="list-style-type: none"> Frequency for encoded tone: 1 Hz to 4 kHz (1-Hz steps) Level for encoded tone: -66 to +3 dBm (1-dBm steps)
Statistics	User-defined measurement resolution: 1, 2, 5, 10, 15, 30 s, 1, 5, 10, 15, 30 min, 1, 2, 4, 6, 12 h Logged information: Alarms (seconds and ratio), Errors (count or count and ratio), Frequency deviation information Event log: Major measurement events incl. errors and alarms are logged with 1-second resolution.
Error Performance	G.821, G.826 or M.2100 analysis of PRBS in received signal, or based on CRC-4, E-bit or FAS: ES, SES, BBE (G.826), UAT, EFS, AT % or count. Error performance evaluation for total measurement: <ul style="list-style-type: none"> HR% for user-defined error performance parameter or programmable OK and not-OK limits for FAS, Pattern, CRC-4 or E-bit count or ratio
APS	APS switching time is measured. A switching time exceeding the user-defined threshold is highlighted. Number of switchovers. Trigger events (User selectable): 2 Mbps alarms (LOF or AIS; pattern bit error) Resolution of APS switching time measurement: LOF and AIS: 0.25 ms
Round Trip Delay (Propagation Time) Measurement	Resolution: 1 μ s Measured Max. time: 10.0 s Interval: 0.5, 1, 2, 5, 10 s

PDH/DSn Testing Specifications

DS1 Common	
Model No.	MU100010A1 (No physical interface. Can set as SDH/SONET client signal.)

DS1 Configuration	
Alarms	Generated and detected: LOS, OOF, AIS (Blue), RAI (Yellow), LSS
Errors	Generated or detected: Pattern, F-bit, S-bit, Pattern slips, BPV (Code), CRC-6, EXZ Error insertion <ul style="list-style-type: none"> • Manual: 1 to 255 consecutive errors • Continuous: 10^{-2}, 10^{-3}, 10^{-4}, 10^{-5}, 10^{-6}, 10^{-7} • For performance: ES, SES
BER Test Pattern	Supported test patterns <ul style="list-style-type: none"> • PRBS 9, PRBS 11, PRBS 15, PRBS 20, PRBS 23, PRBS 29, PRBS 31, QRSS 20 • All 0, All 1, Alternating (1:1), (1:3), (1:7), (3:24), Fox pattern, Fox (CMA 3000) • User-defined up to 32 bits (Length: 1-bit steps) • User-defined up to 2048 bits (Length: 8-bit steps) All patterns can be inverted, except User-define
Loopback Code	Supported loopback codes: LLA, LLD, PLA, PLD, ULB, NLA, USR, ACS, DCS, AN1, DN1, AN2, DN2, 100K, USER_INBAND (User-defined FDL/in-band code) Insertion: On/Off
CAS	CAS signaling bits can be set.
Tone and Speech Signal Insertion	Tone in one speech channel on one transmitter <ul style="list-style-type: none"> • Frequency: 1 Hz to 4 kHz (1-Hz steps) • Level: -70 to +3 dBm (1-dBm steps) • Artificial speech signal
Speech Decode	64 kbps or 56 kbps: μ -law

DS1 Results	
Status	Current Information on <ul style="list-style-type: none"> • Alarms and errors on monitored line • Input level indication • Actual bit rate • Frequency deviation • Contents of one time slot • Framing and CAS bits • Traffic overview: Busy/Idle indication from all 24 channels
Time Slot Monitoring	Contents of single time slot including positive/negative peak values. <ul style="list-style-type: none"> • Frequency for encoded tone: 1 Hz to 4 kHz (1-Hz steps) • Level for encoded tone: -66 to +3 dBm (1-dBm steps)
Statistics	User-defined measurement resolution: 1, 2, 5, 10, 15, 30 s, 1, 5, 10, 15, 30 min, 1, 2, 4, 6, 12 h Logged information: Alarms (seconds and ratio), Errors (count or count and ratio), Frequency deviation information Event log: Major measurement events incl. errors and alarms are logged with 1-second resolution.
Error Performance	G.821, G.826, or M.2100 analysis of PRBS in received signal, or based on detected errors: ES, SES, ALS, UAT, AVT, EFS, BBE (G.826)
APS	APS switching time is measured. A switching time exceeding the user-defined threshold is highlighted. Number of switchovers. Trigger events (User selectable): 1.5 Mbps alarms (OOF, AIS; pattern bit error) APS switching time measurement resolution: No frame, AIS: 0.25 ms
Round Trip Delay (Propagation Time) Measurement	Resolution: 1 μ s Measured Max. time: 10.0 s Interval: 0.5, 1, 2, 5, 10 s

PDH/DSn Testing Specifications

E3 Common	
Model No.	MU100010A1 (No physical interface. Can set as SDH/SONET client signal.)

E3 Configuration	
Alarms	Detected and generated alarms: AIS, No frame, RDI, Pattern sync. loss
Errors	Detected and generated errors: Frame, Code, Pattern, Pattern slip Error insertion <ul style="list-style-type: none"> • Manual: 1 to 255 consecutive errors • Continuous: 10^{-2}, 10^{-3}, 10^{-4}, 10^{-5}, 10^{-6}, 10^{-7} • For performance: ES, SES
BER Test Pattern	Pattern Generation and Detection, Supported test patterns <ul style="list-style-type: none"> • PRBS 9, PRBS 11, PRBS 15, PRBS 20, PRBS 23 • Fox pattern, Fox (CMA 3000), All 0, All 1, Alternating 1:1, Alternating 1:3, Alternating 1:7, Alternating 3:24 • User-defined up to 32 bits (Length: 1-bit steps) • User-defined up to 2048 bits (Length: 8-bit steps) All patterns can be inverted, except user-defined

E3 Results	
Status	Current Information on <ul style="list-style-type: none"> • Alarms and errors on monitored line • Input level indication • Actual bit rate • Frequency deviation
Statistics	User-defined measurement resolution: 1, 2, 5, 10, 15, 30 s, 1, 5, 10, 15, 30 min, 1, 2, 4, 6, 12 h Logged information: Alarms (seconds and ratio), Errors (count or count and ratio), Frequency deviation information Event log: Major measurement events incl. errors and alarms are logged with 1-second resolution.
Error Performance	G.826/M.2100 analysis of received signal, or based on detected errors ES, SES, ALS, UAT, AVT, EFS, BBE (G.826)
Round Trip Delay (Propagation Time) Measurement	Resolution: 1 μ s Measured Max. time: 10.0 s Interval: 0.5, 1, 2, 5, 10 s

DS3 Common	
Model No.	MU100010A1 (No physical interface. Can set as SDH/SONET client signal.)

DS3 Configuration	
Alarms	Detected and generated alarms: LOS, LOF, AIS (Blue), RAI (Yellow), DS3 idle, LSS
Errors	Detected and generated errors: Pattern, C-bit, F-bit, P-bit, Code (BPV), FEBE (detect only), EXZ (detect only) Error insertion <ul style="list-style-type: none"> • Manual: 1 to 255 consecutive errors • Continuous: 10^{-2}, 10^{-3}, 10^{-4}, 10^{-5}, 10^{-6}, 10^{-7}
BER Test Pattern	Pattern generation and detection, Supported test patterns <ul style="list-style-type: none"> • PRBS 9, PRBS 11, PRBS 15, PRBS 20, PRBS 23, PRBS 29, PRBS 31, QRSS 20 • Fox pattern, Fox (CMA 3000), All 0, All 1, Alternating 1:1, Alternating 1:3, Alternating 1:7, Alternating 3:24 • User-defined up to 32 bits (Length: 1-bit steps) • User-defined up to 2048 bits (Length: 8-bit steps) All patterns can be inverted, except user-defined
Loopback Code	Supports FEAC and C-bits loopback (ANSI T1.404 & T1.107a)

PDH/DSn Testing Specifications

DS3 Results	
Status	Current information on <ul style="list-style-type: none"> • Alarms and errors on monitored line • Input level indication • Actual bit rate • Frequency deviation
Statistics	User-defined measurement resolution: 1, 2, 5, 10, 15, 30 s, 1, 5, 10, 15, 30 min, 1, 2, 4, 6, 12 h Logged information: Alarms (seconds and ratio), Errors (count or count and ratio), Frequency deviation Event log: Major measurement events incl. errors and alarms are logged with 1-second resolution.
Error Performance	G.826/M.2100 analysis of received signal, or based on detected errors ES, SES, ALS, UAT, AVT, EFS, BBE (G.826)
Round Trip Delay (Propagation Time) Measurement	Resolution: 1 μ s Measured Max. time: 10.0 s Interval: 0.5, 1, 2, 5, 10 s

E4 Common	
Model No.	MU100010A1 (No physical interface. Can set as SDH/SONET client signal.)

E4 Configuration	
Alarms	Detected and generated alarms: AIS, No frame, RDI, Pattern sync. loss
Errors	Detected and generated errors: Frame, Pattern error, Pattern slips Error insertion <ul style="list-style-type: none"> • Manual: 1 to 255 consecutive errors • Continuous: 10^{-2}, 10^{-3}, 10^{-4}, 10^{-5}, 10^{-6}, 10^{-7} • For performance: ES, SES
BER Test Pattern	Pattern generation and detection, Supported test patterns <ul style="list-style-type: none"> • PRBS 9, PRBS 11, PRBS 15, PRBS 20, PRBS 23, PRBS 29, PRBS 31, QRSS 20 • All 0, All 1, Alternating 1:1, Alternating 1:3, Alternating 1:7, Alternating 3:24 • User-defined up to 32 bits (Length: 1-bit steps) • User-defined up to 2048 bits (Length: 8-bit steps) All patterns can be inverted, except user-defined

E4 Results	
Status	Current information on <ul style="list-style-type: none"> • Alarms and errors on monitored line • Input level indication • Actual bit rate • Frequency deviation
Statistics	User-defined measurement resolution: 1, 2, 5, 10, 15, 30 s, 1, 5, 10, 15, 30 min, 1, 2, 4, 6, 12 h Logged information: Alarms (seconds and ratio), Errors (count or count and ratio), Frequency deviation Event log: Major measurement events incl. errors and alarms are logged with 1-second resolution.
Error Performance	G.826/M.2100 analysis of received signal, or based on detected errors ES, SES, ALS, UAT, AVT, EFS, BBE (G.826)
Round Trip Delay (Propagation Time) Measurement	Resolution: 1 μ s Measured Max. time: 10.0 s Interval: 0.5, 1, 2, 5, 10 s

Device Testing Specification

Device Test	
Model No.	MU100011A
Interface Type	QSFP+, SFP28, CFP4, QSFP28
Supported Bit Rate	25.78 Gbps (25 GigE), 41.25 Gbps (40 GigE), 103.12 Gbps (100 GigE), 43.01 Gbps (OTU3), 44.57 Gbps (OTU3e1), 44.58 Gbps (OTU3e2), 111.80 Gbps (OUT4)
Lane Select	1 Lane (SFP28), 4 Lane (QSFP+, CFP4*, QSFP28*), 20 Lane (CFP4, QSFP28)
Timing Source	Internal clock, External clock
Test Pattern	PRBS 7, PRBS 9, PRBS 15, PRBS 23, PRBS 31, Logic Inverted
Frequency Offset	±200 ppm (0.1 ppm step)
Error Insertion	Item: Bit error Insertion timing: Single
Monitor	Signal level: dBm Frequency: Hz, ppm LOS, LSS, CDR lock, Bit error
Measurement	Bit error, Frequency

*: The CFP4 and QSFP28 can select test patterns for each lane.

Optical Transceivers Interface List

MU110010A1	Model/Order No.	Name	Form Factor	100 Meg Ethernet	156 Meg STM-1	614 Meg CPRI	622 Meg STM-4	768 Meg OBSAI	1GFC	1.23 Gig CPRI	1.25 Gig Ethernet	1.54 Gig OBSAI	2GFC	2.46 Gig CPRI	2.488 Gig STM-16	2.67 Gig OTU1	3.07 Gig CPRI/OBSAI	4GFC	4.92 Gig CPRI	6.14 Gig CPRI/OBSAI	8GFC	9.83 Gig CPRI	9.95 Gig STM-64	10.1 Gig CPRI	10.3 Gig Ethernet	10GFC	10.7 Gig OTU2	11.05 Gig OTU1e	11.09 Gig OTU2e	11.27 Gig OTU1f	11.3 Gig OTU2f	16GFC	25G Ethernet	40G Ethernet	40G OTN	100G Ethernet	100G OTN			
✓	✓	G0332A	100M FX 1310 nm MM SFP	SFP	1310 nm, MM, 2 km																																			
✓	✓	G0319A	Up to 2.7G 1310 nm 15 km SFP	SFP							1310 nm, SM, 15 km																													
✓	✓	G0320A	Up to 2.7G 1310 nm 40 km SFP	SFP							1310 nm, SM, 40 km																													
✓	✓	G0321A	Up to 2.7G 1550 nm 80 km SFP	SFP							1550 nm, SM, 80 km																													
✓	✓	G0328A	1G/2G/4G FC 850 nm SFP	SFP							850 nm, MM, 0.5 km																													
✓	✓	G0322A	1G/2G/4G FC 1310 nm SFP	SFP							1310 nm, SM, 10 km																													
✓	✓	G0323A	1G/2G/4G FC 1550 nm SFP	SFP							1550 nm, SM, 40 km																													
✓	✓	G0315A	10G LR/LW 1310 nm SFP+	SFP+																																				
✓	✓	G0316A	10G ER/EW 1550 nm 40 km SFP+	SFP+																																				
✓	✓	G0318A	10G ZR/ZW 1550 nm 80 km SFP+	SFP+																																				
✓	✓	G0329A	10G LR 1310 nm SFP+	SFP+							1310 nm, SM, 10 km																													
✓	✓	G0356A	8G FC/10G SR 850 nm SFP+	SFP+																																				
✓		G0386A	16GFC SR 850 nm SFP+	SFP+																																				
✓		G0387A	16GFC LR 1310 nm SFP+	SFP+																																				
✓		G0388A	25G SR 850 nm SFP28	SFP28																																				
✓		G0389A	25G LR 1310 nm SFP28	SFP28																																				
✓		G0359A	40G SR4 850 nm QSFP+	QSFP+																																				
✓		G0334A	40G LR4 1310 nm QSFP+	QSFP+																																				
✓		G0366A	100G SR4 850 nm QSFP28	QSFP28																																				
✓		G0434A	100G LR4 Dual Rate 1310 nm QSFP28	QSFP28																																				
✓		G0426A	QSFP28 100GBASE-DR	QSFP28																																				
✓		G0427A	QSFP28 100GBASE-FR1	QSFP28																																				
✓		G0369A	100G LR4 Dual Rate 1310 nm CFP4	CFP4																																				

Optical Transceivers Specification

Model/Order No.	Description (Approx. Distance)	Max. Input Power	Input Sensitivity	Input Wavelength	Output Power	Output Wavelength	Loop Back
G0332A 100M FX 1310 nm MM SFP	100BASE - FX 1310 nm multi mode (2 km)	-14 dBm	-31 dBm	1270 nm to 1600 nm	-20 to -15 dBm	1280 nm to 1380 nm	OK
G0319A Up to 2.7G 1310 nm 15 km SFP	STM-1/4/16 short haul 1310 nm single mode (15 km)	0 dBm	-18 dBm	1270 nm to 1580 nm	-5 to 0 dBm	1260 nm to 1360 nm	OK
G0320A Up to 2.7G 1310 nm 40 km SFP	STM-1/4/16 long haul 1310 nm single mode (40 km)	-9 dBm	-27 dBm	1270 nm to 1580 nm	-2 to +3 dBm	1280 nm to 1335 nm	>12 dB ATT
G0321A Up to 2.7G 1550 nm 80 km SFP	STM-1/4/16 long haul 1550 nm single mode (80 km)	-9 dBm	-28 dBm	1270 nm to 1580 nm	-2 to +3 dBm	1500 nm to 1580 nm	>12 dB ATT
G0328A 1G/2G/4G FC 850 nm SFP	1GFC, 2GFC, 4GFC 850 nm multi mode (0.5 km)	-3 dBm	-15 dBm	830 nm to 860 nm	-9 to 0 dBm	830 nm to 860 nm	>3 dB ATT
G0322A 1G/2G/4G FC 1310 nm SFP	1GFC, 2GFC, 4GFC 1310 nm single mode (10 km)	-3 dBm	-18 dBm	1260 nm to 1360 nm	-8 to 0 dBm	1260 nm to 1360 nm	>3 dB ATT
G0323A 1G/2G/4G FC 1550 nm SFP	1GFC, 2GFC, 4GFC 1550 nm single mode (40 km)	-3 dBm	-18 dBm	1470 nm to 1600 nm	0 to +5 dBm	1510 nm to 1590 nm	>8 dB ATT
G0315A 10G LR/LW 1310 nm SFP+	10GBASE - LR 1310 nm single mode (10 km)	+0.5 dBm	-14.4 dBm	1260 nm to 1565 nm	-6 to -1 dBm	1290 nm to 1330 nm	OK
G0316A 10G ER/EW 1550 nm 40 km SFP+	10GBASE - ER 1550 nm single mode (40 km)	-1 dBm	-15.8 dBm	1260 nm to 1565 nm	-3 to +3 dBm	1530 nm to 1560 nm	>4 dB ATT
G0318A 10G ZR/ZW 1550 nm 80 km SFP+	10GBASE - ER 1550 nm single mode (80 km)	-8 dBm	-22 dBm	1260 nm to 1565 nm	0 to +5 dBm	1525 nm to 1565 nm	>13 dB ATT
G0329A 10G LR 1310 nm SFP+	10GBASE - LR 1310 nm single mode (10 km)	+0.5 dBm	-14 dBm	1260 nm to 1355 nm	-8.2 to +0.5 dBm	1260 nm to 1355 nm	OK
G0356A 8G FC/10G SR 850 nm SFP+	8GFC, 10GFC, 10GBASE - SR 850 nm multi mode (0.3 km)	-1 dBm	-11.1 dBm	840 nm to 860 nm	-7.3 to -1 dBm	840 nm to 860 nm	OK
G0386A 16GFC SR 850 nm SFP+	16GFC 850 nm multi mode (0.035 km)	0 dBm	-10.5 dBm	840 nm to 860 nm	-7.5 dBm ~	840 nm to 860 nm	OK
G0387A 16GFC LR 1310 nm SFP+	16GFC 1310 nm single mode (10 km)	+2 dBm	-12 dBm	1295 nm to 1325 nm	-5 to +2 dBm	1295 nm to 1325 nm	OK
G0388A 25G SR 850 nm SFP28	25GBASE - SR 850 nm multi mode (0.1 km)	+2.4 dBm	-10.3 dBm	840 nm to 860 nm	-8.4 to +2.4 dBm	840 nm to 860 nm	OK
G0389A 25G LR 1310 nm SFP28	25GBASE - LR 1310 nm single mode (10 km)	+2 dBm	-13.3 dBm	1260 nm to 1350 nm	-7 to +2 dBm	1295 nm to 1325 nm	OK
G0359A 40G SR4 850 nm QSFP+	40GBASE - SR4 850 nm multi mode (0.1 km)	+2.4 dBm (per Lane)	-9.9 dBm	840 nm to 860 nm	-8 to +2.4 dBm	840 nm to 860 nm	OK
G0334A 40G LR4 1310nm QSFP+	40G Ethernet/OTN 1310 nm single mode (10 km)	+2.3 dBm (per Lane)	-11.5 dBm (per Lane)	1264.5 nm to 1277.5 nm 1284.5 nm to 1297.5 nm 1304.5 nm to 1317.5 nm 1324.5 nm to 1337.5 nm	+8.3 dBm (max.) (Total) -2 to +2.3 dBm (per Lane)	1264.5 nm to 1277.5 nm 1284.5 nm to 1297.5 nm 1304.5 nm to 1317.5 nm 1324.5 nm to 1337.5 nm	OK
G0366A 100G SR4 850 nm QSFP28	100G Ethernet 850 nm multi mode (0.1 km)	+2.4 dBm (per Lane)	-9.9 dBm (per Lane)	840 nm to 860 nm	+8.9 dBm (max.) (Total) -9.1 to +2.4 dBm (per Lane)	840 nm to 860 nm	OK
G0434A 100G LR4 Dual Rate 1310 nm QSFP28	100G Ethernet /OTN 1310 nm single mode (10 km)	+4 dBm (per Lane)	-8.4 dBm (per Lane)	1294.53 nm to 1296.59 nm 1299.02 nm to 1301.09 nm 1303.54 nm to 1305.63 nm 1308.09 nm to 1310.19 nm	+10 dBm (max.) (Total) -0.6 to +4 dBm (per Lane)	1294.53 nm to 1296.59 nm 1299.02 nm to 1301.09 nm 1303.54 nm to 1305.63 nm 1308.09 nm to 1310.19 nm	OK
G0426A QSFP28 100GBASE-DR	100G Ethernet 1310 nm single mode (0.5 km)	+4 dBm (per Lane)	-5.9 dBm	1304.5 nm to 1317.5 nm	-2.9 to +4 dBm	1304.5 nm to 1317.5 nm	OK
G0427A QSFP28 100GBASE-FR1	100G Ethernet 1310 nm single mode (2 km)	+4.5 dBm (per Lane)	-6.4 dBm	1304.5 nm to 1317.5 nm	-2.4 to +4 dBm	1304.5 nm to 1317.5 nm	OK
G0369A 100G LR4 Dual Rate 1310 nm CFP4	100G Ethernet /OTN 1310 nm single mode (10 km)	+4.5 dBm (per Lane)	-8.6 dBm (per Lane)	1294.53 nm to 1296.59 nm 1299.02 nm to 1301.09 nm 1303.54 nm to 1305.63 nm 1308.09 nm to 1310.19 nm	+10.5 dBm (max.) (Total) -4.3 to +4.5 dBm (per Lane)	1294.53 nm to 1296.59 nm 1299.02 nm to 1301.09 nm 1303.54 nm to 1305.63 nm 1308.09 nm to 1310.19 nm	OK

Ordering Information



Please specify the model/order number, name and quantity when ordering.
The names listed in the chart below are Order Names. The actual name of the item may differ from the Order Name.

Mainframe

Model/Order No.	Name
MT1000A	Network Master Pro
Standard Accessories	
MT1000A-006*1	High Power Supply: Installed
	Line Cord*2: 1 pc
B0745A	Softcase: 1 pc
B0728A*3	Rear Panel kit: 1 pc
G0385A*4	High Power AC Adaptor: 1 pc
G0310A	Li-ion Battery: 1 pc
Z1746A	Stylus: 1 pc
Z1747A*5	Carrying Strap: 1 pc
Z1748A*6	Handle: 1 pc
Z1817A*7	Utilities ROM: 1 pc
Options	
MT1000A-003*8	Connectivity for WLAN/Bluetooth
MT1000A-005*9	AUX I/O

Model/Order No.	Name
Optional Accessories	
B0691B*10	Hard Case
B0720A	Rear Panel
B0729A*11	Screw 1U
B0730A*11	Screw 2U
B0731A*11	Screw 3U
B0732A*12	Screw Kit
G0382A*13	Autofocus Video Inspection Probe
G0306C*13	Video Inspection Probe
G0309A*4	AC Adapter
G0324A	Battery Charger
G0325A	GPS Receiver
Z1821A*14	Utilities in USB Stick

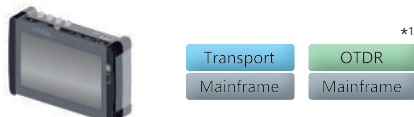
Module Configuration*15

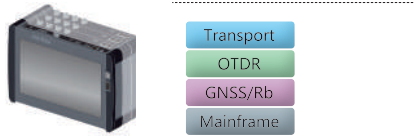
1 Module		<ul style="list-style-type: none"> Mainframe Network Master Pro MT1000A Transport 10G Multirate MU100010A1, 100G Multirate MU100011A OTDR 1310/1550 nm SMF MU100020A, 1310/1550/850/1300 nm SMF/MMF MU100021A, 1310/1550/1625 nm SMF MU100022A, 1310/1550 nm, 1650 nm SMF MU100023A GNSS/Rb Sync Module High Performance GPS Disciplined Oscillator MU100090A, High Performance GNSS Disciplined Oscillator MU100090B
2 Modules		
3 Modules		

*1: The presence of the MT1000A-006 option can be recognized at the top right of the front panel. To retrofit to the already shipped item, please contact us.



Without MT1000A-006

With in MT1000A-006

- *2: One line cord is attached to the area to shipment.
- *3: Composed of B0720A, B0729A, B0730A and B0731A. Refer to Module Composition for the module combination.
- *4: The MT1000A with MT1000A-006 can be used. Use the AC adapter when using the MT1000A without MT1000A-006 installed.
- *5: Shoulder strap for MT1000A.
- *6: Hand strap for MT1000A.
- *7: This DVD includes PDF files and formatting tools of each product's instruction manual (such as W3933AE, W3810AE, W3736AE, W3946AE).
- *8: WLAN is available for certified countries and regions including USA, Canada, Japan and EU countries. Please visit the Anritsu web site for updated information.
- *9: MT1000A-005 is required for MU100090B. To retrofit to the already shipped item, please contact us.

*10: Can use module 1 to 2 in combination

*11: Includes 4 bolts of same length

*12: Includes B0729A, B0730A and B0731A

*13: This fiberscope uses the VIP function in the MT1000A Utility menu. Different tip types are used by the G0382A and G0306C.



G0382A

G0306C

*14: Include MT1000A Operation Manual and the Remote Script Manual.

*15: Any modular combination as shown in a figure.

*16: Required if the transport module is not used rear cover.

Ordering Information

Measurement Module

10G Multirate Module MU100010A1

Model/Order No.	Name
MU100010A1	10G Multirate Module
Standard Accessories	
W3935AE	MT1000A Transport Module Quick Reference Guide: 1 pc
B0692A*1	ESD Box (for optical modules)

*1: Up to four SFP+/SFPs can be stored.

Module Options*2

Model/Order No.	Name
Low Rate	
MU100010A-001*3	Up to 2.7G Dual Channel
Ethernet	
MU100010A-011	Ethernet 10G Single Channel
MU100010A-012	Ethernet 10G Dual Channel
MU100010A-020*4	TCP Throughput
OTN	
MU100010A-051	OTN 10G Single Channel
MU100010A-052	OTN 10G Dual Channel
MU100010A-061*5	ODU Multiplexing
MU100010A-062*5	ODU Flex

Model/Order No.	Name
CPRI/OBSAI	
MU100010A-071	CPRI/OBSAI Up to 5G Dual Channel
MU100010A-072	CPRI/OBSAI 6G to 10G Single Channel
MU100010A-073	CPRI/OBSAI 6G to 10G Dual Channel
Fibre Channel	
MU100010A-002	FC 1G 2G 4G Dual Channel
MU100010A-091	FC 8G 10G Single Channel
MU100010A-092	FC 8G 10G Dual Channel
SDH/SONET	
MU100010A-081	STM-64 OC-192 Single Channel
MU100010A-082	STM-64 OC-192 Dual Channel

*2: These options can be retrofitted.

The Model/Order No. of retrofit options is "-3**".

Example

MU100010A-001 Up to 2.7G Dual Channel becomes MU100010A-301 Up to 2.7G Dual Channel Retrofit.

When retrofitting an option, please either specify one of the following media along with the relevant option, or Web download.

Z1849A: DVD-ROM for Retrofit Options

Z1850A: USB Stick for Retrofit Options

*3: Includes OTN (OTU1), Ethernet (10 Mbps, 100 Mbps, 1 Gbps), SDH up to STM-16, and SONET up to OC-48.

*4: Requires that at least one of the following options is installed: MU100010A-001, MU100010A-011, MU100010A-012

*5: Requires that at least one of the following options is installed: MU100010A-001, MU100010A-051, MU100010A-052

Correspondence Ports by MU100010A1 Options

Standard (Bit Rate)		Interface	The Number Of Correspondence Ports by MU100010A1 Options													
			001	002	011	012	051	052	071	072	073	081	082	091	092	
Ethernet	10/100/1000M (Electrical)	RJ45	2 Port													
	100BASE-FX (125M)	SFP	2 Port													
	10GBASE-XR (10.3125G)	SFP+			1 Port	2 Port										
	10GBASE-XW (9.953G)															
OTN	OTU1 (2.666G)	SFP	2 Port													
	OTU2 (10.709G)	SFP+														
	OTU1e (11.049G)															
	OTU2e (11.096G)						1 Port	2 Port								
	OTU1f (11.270G)															
OTU2f (11.318G)																
Mobile X Haul	eCPRI/RoE 10/100/1000M (Electrical)	RJ45	2 Port													
	eCPRI/RoE 1000BASE-x	SFP	2 Port													
	eCPRI/RoE 10GBASE-x	SFP+			1 Port	2 Port										
	CPRI Option1 (614.4M)	SFP														
	OBSAI 1x (768.0M)															
	CPRI Option2 (1228.8M)															
	OBSAI 2x (1536.0M)															
	CPRI Option3 (2457.6M)															
	CPRI Option4 (3072.0M)	SFP+														
	OBSAI 4x (3072.0M)															
CPRI Option5 (4915.2M)																
CPRI Option6 (6144.0M)																
OBSAI 8x (6144.0M)																
CPRI Option7 (9830.4M)																
CPRI Option8 (10137.6M)																
Fibre Channel	1GFC (1.063G)	SFP		2 Port												
	2GFC (2.125G)															
	4GFC (4.250G)															
SDH/SONET	8GFC (8.500G)	SFP+												1 Port	2 Port	
	10GFC (10.520G)															
SDH/SONET	STM-1/OC-3 (155.52M)	SFP	2 Port													
	STM-4/OC-12 (622.08M)															
	STM-64/OC-192 (9.953G)		SFP+											1 Port	2 Port	

Ordering Information

Measurement Module

100G Multirate Module MU100011A

Model/Order No.	Name
MU100011A*6	100G Multirate Module
Standard Accessories	
W3935AE	MT1000A Transport Module Quick Reference Guide: 1 pc
B0763A*7	ESD Box (for Optical modules): 1 pc

*6: MT1000A-006 is required for MU100011A.

*7: One CFP4 plus either up to two QSFP28s or up to four SFP/SFP+s can be stored.

Module Options*2

Model/Order No.	Name
Standard	
MU100011A-001*8	Up to 10G Single Channel
MU100011A-003*8	Up to 10G Dual Channel
Ethernet	
MU100011A-013*9	Ethernet 40G Single Channel
MU100011A-015*9	Ethernet 100G Single Channel
MU100011A-017*10	Ethernet 25G Single Channel
MU100011A-020*11	TCP Throughput
MU100011A-021*12	SyncE Wander
MU100011A-023*13	RS-FEC for 100GBASE-SR4
MU100011A-024*13	RS-FEC(544,514) for 100GBASE-xR
OTN	
MU100011A-053	OTN 40G Single Channel
MU100011A-055	OTN 100G Single Channel
MU100011A-062*14	ODU Flex
MU100011A-063*14	ODU Multiplexing/Multi Stage

Model/Order No.	Name
Fibre Channel	
MU100011A-004	Up to 10G FC Single Channel
MU100011A-005	Up to 10G FC Dual Channel
MU100011A-091	FC 16G Single Channel
eCPRI/RoE/CPRI/OBSAI	
MU100011A-071	CPRI/OBSAI Up to 10G Single Channel
MU100011A-072	CPRI/OBSAI Up to 10G Dual Channel
MU100011A-073	CPRI 12/25G Single Channel
MU100011A-074	CPRI 12/25G Dual Channel
MU100011A-075*10	eCPRI/RoE 25G Dual Channel
SDH/SONET	
MU100011A-083*15	STM-256/OC-768 Client Signal

*8: Only one of these option can be installed.

Included OTN(OTU1, OTU1e, OTU1f, OTU2, OTU2e, OTU2f), Ethernet up to 10 Gbps, SDH up to STM-64 and SONET up to OC-192.

*9: FEC is always Off.

*10: FEC selectable On/Off.

*11: Requires that at least one of the following option is installed: MU100011A-001, MU100011A-003

*12: In addition to the MT1000A-005, at least one of the following options is required: MU100011A-001, MU100011A-003, MU100011A-017

*13: Requires to MU100011A-015

*14: Requires that at least one of the following option is installed: MU100011A-001, MU100011A-003, MU100011A-053, MU100011A-055

*15: MU100011A does not have a physical interface of the option. In combination with MU100011A-053, can be used as a client signal by OTN.

Correspondence Ports by MU100011A Options

Standard (Bit Rate)		Interface	The Number Of Correspondence Ports by MU100011A Options															
			001	003	013	015	017	053	055	004	005	091	071	072	073	074	075	
Ethernet	10/100/1000M (Electrical)	RJ45	1 Port	2 Port														
	100BASE-FX (125M)	SFP	1 Port	2 Port														
	1000BASE-X (1.25G)	SFP+	1 Port	2 Port														
	10GBASE-XR (10.3125G)	SFP28					1 Port											
	10GBASE-XW (9.953G)	QSFP28																
	25GBASE-XX (25.781G)	QSFP+			1 Port													
OTN	40GBASE-XX4 (41.250G)	CFP4, QSFP28				1 Port												
	100GBASE-XX4 (103.125G)	SFP	1 Port	2 Port														
	OTU1 (2.666G)	SFP+	1 Port	2 Port														
	OTU2 (10.709G)																	
	OTU1e (11.049G)																	
	OTU2e (11.096G)																	
Mobile X Haul	OTU1f (11.270G)																	
	OTU2f (11.318G)																	
	OTU3 (43.018G)																	
	OTU3e1 (44.571G)	QSFP+						1 Port										
	OTU3e2 (44.583G)																	
	OTU4 (111.810G)	CFP4, QSFP28								1 Port								
	Fibre Channel	eCPRI/RoE 10/100/1000M (Electrical)	RJ45	1 Port	2 Port													
		eCPRI/RoE 1000BASE-x	SFP	1 Port	2 Port													
		eCPRI/RoE 10GBASE-xx	SFP+	1 Port	2 Port													
		eCPRI/RoE 25GBASE-xx	SFP28					1 Port										
eCPRI/RoE 40GBASE-xx		QSFP+			1 Port													
eCPRI/RoE 100GBASE-xx		CFP4, QSFP28				1 Port												
CPRI Option1 (614.4M)																		
OBSAI 1x (768.0M)																		
CPRI Option2 (1228.8M)																		
OBSAI 2x (1536.0M)		SFP										1 Port	2 Port					
SDH/SONET	CPRI Option3 (2457.6M)																	
	CPRI Option4 (3072.0M)																	
	OBSAI 4x (3072.0M)																	
	CPRI Option5 (4915.2M)																	
	CPRI Option6 (6144.0M)																	
	OBSAI 8x (6144.0M)	SFP+										1 Port	2 Port					
	CPRI Option7 (9830.4M)																	
	CPRI Option8 (10137.6M)																	
	CPRI Option9 (12165.12M)	SFP+																
	CPRI Option10 (24330.24M)	SFP28													1 Port	2 Port		

Ordering Information

High Performance GNSS Disciplined Oscillator MU100090B

Model/Order No.	Name
MU100090B*1	High Performance GNSS Disciplined Oscillator
Standard Accessories	
J1705A	AUX Conversion Adaptor
J1886A*2	GNSS Antenna
J1710A	BNC Cable (20 cm) × 2
Z2122A	Tripod for GNSS Antenna
Optional Software	
MU100090B-001	High Stability/Multi-Band
MU100090B-002	Multi-GNSS

*1: Excellent Eco Product non-compliant.

*2: With 5 m cable, IP67 Ingress protection.

MT1000A-005 and Ethernet options are required for MU100090B.

High Performance GPS Disciplined Oscillator MU100090A

Model/Order No.	Name
MU100090A*3, *4	High Performance GPS Disciplined Oscillator
Standard Accessories	
J1705A	AUX Conversion Adaptor
J1706A*3	GPS Antenna
J1710A	BNC Cable (20 cm) × 2

*3: Cannot be shipped to EU/EFTA countries and UK because of not being RoHS 10 compliant.

*4: Excellent Eco Product non-compliant.

MT1000A-005 and Ethernet options are required for MU100090A.

Optional Accessories

Model/Order No.	Name
Operation Manuals	
W3933AE	MT1000A Transport Module Operation Manual
W3736AE	MT1000A/MT1100A Remote Scripting Operation Manual
Optical Modules	
G0332A	100M FX 1310 nm MM SFP
G0319A	Up to 2.7G 1310 nm 15 km SFP
G0320A	Up to 2.7G 1310 nm 40 km SFP
G0321A	Up to 2.7G 1550 nm 80 km SFP
G0328A	1G/2G/4G FC 850 nm SFP
G0322A	1G/2G/4G FC 1310 nm SFP
G0323A	1G/2G/4G FC 1550 nm SFP
G0315A	10G LR/LW 1310 nm SFP+
G0316A	10G ER/EW 1550 nm 40 km SFP+
G0318A	10G ZR/ZW 1550 nm 80 km SFP+
G0329A	10G LR 1310 nm SFP+
G0356A	8G FC/10G SR 850 nm SFP+
G0386A	16GFC SR 850 nm SFP+
G0387A	16GFC LR 1310 nm SFP+
G0388A	25G SR 850 nm SFP28
G0389A	25G LR 1310 nm SFP28
G0359A	40G SR4 850 nm QSFP+
G0334A	40G LR4 1310 nm QSFP+
G0366A	100G SR4 850 nm QSFP28
G0434A	100G LR4 Dual Rate 1310 nm QSFP28
G0369A	100G LR4 Dual Rate 1310 nm CFP4
G0426A	QSFP28 100GBASE-DR
G0427A	QSFP28 100GBASE-FR1

Model/Order No.	Name
Cables	
J1571A	Optical Cable SM LC/PC to SC/PC 3 m
J1575A	Optical Cable SM LC/PC to FC/PC 3 m
J1579A	Optical Cable SM LC/PC to LC/PC 3 m
J1581A	Optical Cable MM LC/PC to LC/PC 3 m
J1583A	Optical Attenuator 10 dB LC/PC to LC/PC
J1584A	RJ45 Cable 3 m
J1710A*5	BNC Cable 0.2 m
J0127B*5	COAXIAL CORD, 2.0 M
MU100090B Antenna Extension Cables	
J1904A	Antenna Extension Cable 25 m Kit
J1905A	Antenna Extension Cable 50 m Kit
J1906A	Antenna Extension Cable 75 m Kit
J1901A	Antenna Extension Cable 25 m (TNC-P, N-J)
J1902A	Antenna Extension Cable 25 m (N-P, N-J)
J1903A	Antenna Extension Patch Cable 0.4 m (N-P, SMA-P)

*5: 50Ω impedance cable for MU100090B and main-frame external clock input connector

Maintenance Service

Model/Order No.	Name	Supported Modules
MT1000A-ES210	2 Years Extended Warranty Service	MT1000A
MT1000A-ES310	3 Years Extended Warranty Service	
MT1000A-ES510	5 Years Extended Warranty Service	
MU100010A1-ES210	2 Years Extended Warranty Service	MU100010A1
MU100010A1-ES310	3 Years Extended Warranty Service	
MU100010A1-ES510	5 Years Extended Warranty Service	
MU100011A-ES210	2 Years Extended Warranty Service	MU100011A
MU100011A-ES310	3 Years Extended Warranty Service	
MU100011A-ES510	5 Years Extended Warranty Service	
MU100090A-ES210	2 Years Extended Warranty Service	MU100090A
MU100090A-ES310	3 Years Extended Warranty Service	
MU100090A-ES510	5 Years Extended Warranty Service	
MU100090B-ES210	2 Years Extended Warranty Service	MU100090B
MU100090B-ES310	3 Years Extended Warranty Service	
MU100090B-ES510	5 Years Extended Warranty Service	

Ordering Information

Remote Software Service

The following licenses must be purchased to use the MX109020A Site Over Remote Access.

Mainframe Option License

Model/Order No.	Name
MT1000A-003*1	Connectivity for WLAN/Bluetooth
MT1000A-011*2	Site Over Remote Access Connect

*1: Available for certified countries and regions including USA, Canada, Japan and EU countries. Please visit the Anritsu web site for updated information.

*2: Validity period is unlimited. An open TCP port may be required to allow the MT1000A to be connected from an in-company LAN to MX109020A, depending on the LAN security policy.

Subscription Option License

Model/Order No.	Name
MX109020A*3, *5, *6, *7	Site Over Remote Access Basic License
MX109020A-TL001*3, *4	Site Over Remote Access 1 Year License
MX109020A-001*5	Site Over Remote Access 8 Units
MX109020A-002*5	Site Over Remote Access Unlimited Units
MX109020A-003*8	Centralized Data Management

*3: We recommend purchasing a 1-year license in addition to the basic license.

*4: When extending the usage period, we recommend purchasing in 1-year license periods

*5: Up to two measuring instruments can be remotely controlled simultaneously with the basic license.

This number can be increased to up to 8 units by purchasing the MX109020A-001 option, and up to 100 units by purchasing the MX109020A-002 option.

*6: You must agree to the service terms before purchasing SORA.

Refer to the service terms at the following URL: <https://www.anritsu.com/en-us/test-measurement/support/downloads/manuals/dwl20059>

*7: This product cannot be used in some regions and countries; please read the service terms for more details.

*8: Users must provide their own storage at the upload destination.

- **United States**

- **Anritsu Americas Sales Company**

450 Century Parkway, Suite 190, Allen, TX 75013 U.S.A.
Phone: +1-800-Anritsu (1-800-267-4878)

- **Canada**

- **Anritsu Electronics Ltd.**

- **Americas Sales and Support**

450 Century Parkway, Suite 190, Allen, TX 75013 U.S.A.
Phone: +1-800-Anritsu (1-800-267-4878)

- **Brazil**

- **Anritsu Eletronica Ltda.**

Praça Amadeu Amaral, 27 - 1 Andar
01327-010 - Bela Vista - Sao Paulo - SP, Brazil
Phone: +55-11-3283-2511
Fax: +55-11-3288-6940

- **Mexico**

- **Anritsu Company, S.A. de C.V.**

Bldv Miguel de Cervantes Saavedra #169 Piso 1, Col. Granada
Mexico, Ciudad de Mexico, 11520, MEXICO
Phone: +52-55-4169-7104

- **United Kingdom**

- **Anritsu EMEA Ltd.**

200 Capability Green, Luton, Bedfordshire, LU1 3LU, U.K.
Phone: +44-1582-433200
Fax: +44-1582-731303

- **France**

- **Anritsu S.A.**

12 avenue du Québec, Immeuble Goyave,
91140 VILLEBON SUR YVETTE, France
Phone: +33-1-60-92-15-50

- **Germany**

- **Anritsu GmbH**

Nemetschek Haus, Konrad-Zuse-Platz 1,
81829 München, Germany
Phone: +49-89-442308-0
Fax: +49-89-442308-55

- **Italy**

- **Anritsu S.r.l.**

Spaces Eur Arte, Viale dell'Arte 25, 00144 Roma, Italy
Phone: +39-6-509-9711

- **Sweden**

- **Anritsu AB**

Kistagången 20 B, 2 tr, 164 40 Kista, Sweden
Phone: +46-8-534-707-00

- **Finland**

- **Anritsu AB**

Technopolis Aviapolis, Teknobulevardi 3-5 (D208.5),
FI-01530 Vantaa, Finland
Phone: +358-20-741-8100

- **Denmark**

- **Anritsu A/S**

c/o Regus Winghouse, Ørestads Boulevard 73, 4th floor,
2300 Copenhagen S, Denmark
Phone: +45-7211-2200

- **Spain**

- **Anritsu EMEA GmbH**

- **Representation Office in Spain**

Calle Manzanares 4, Primera planta, 28005 Madrid, Spain
Phone: +34-91-572-6761

- **Austria**

- **Anritsu EMEA GmbH**

Am Belvedere 10, A-1100 Vienna, Austria
Phone: +43-(0)1-717-28-710

- **United Arab Emirates**

- **Anritsu A/S**

Office No. 164, Building 17, Dubai Internet City
P. O. Box – 501901, Dubai, United Arab Emirates
Phone: +971-4-3758479

- **India**

- **Anritsu India Private Limited**

6th Floor, Indiqube ETA, No.38/4, Adjacent to EMC2,
Doddanekundi, Outer Ring Road, Bengaluru – 560048, India
Phone: +91-80-6728-1300
Fax: +91-80-6728-1301

- **Singapore**

- **Anritsu Pte. Ltd.**

1 Jalan Kilang Timor, #07-04/06 Pacific Tech Centre
Singapore 159303
Phone: +65-6282-2400
Fax: +65-6282-2533

- **Vietnam**

- **Anritsu Company Limited**

16th Floor, Peakview Tower, 36 Hoang Cau Street, O Cho Dua Ward,
Dong Da District, Hanoi, Vietnam
Phone: +84-24-3201-2730

- **P.R. China (Shanghai)**

- **Anritsu (China) Co., Ltd.**

Room 2701-2705, Tower A, New Caohejing International
Business Center No. 391 Gui Ping Road Shanghai, 200233, P.R. China
Phone: +86-21-6237-0898
Fax: +86-21-6237-0899

- **P.R. China (Hong Kong)**

- **Anritsu Company Ltd.**

Unit 1006-7, 10/F., Greenfield Tower, Concordia Plaza,
No. 1 Science Museum Road, Tsim Sha Tsui East,
Kowloon, Hong Kong, P.R. China
Phone: +852-2301-4980
Fax: +852-2301-3545

- **Japan**

- **Anritsu Corporation**

8-5, Tamura-cho, Atsugi-shi, Kanagawa, 243-0016 Japan
Phone: +81-46-296-6509
Fax: +81-46-225-8352

- **Korea**

- **Anritsu Corporation, Ltd.**

8F, A TOWER, 20, Gwacheondaero 7-gil, Gwacheon-si,
Gyeonggi-do, 13840, Republic of Korea
Phone: +82-2-6259-7300
Fax: +82-2-6259-7301

- **Australia**

- **Anritsu Pty. Ltd.**

Unit 20, 21-35 Ricketts Road, Mount Waverley, Victoria 3149, Australia
Phone: +61-3-9558-8177
Fax: +61-3-9558-8255

- **Taiwan**

- **Anritsu Company Inc.**

7F, No. 316, Sec. 1, NeiHu Rd., Taipei 114, Taiwan
Phone: +886-2-8751-1816
Fax: +886-2-8751-1817